

SERPAC CA8B4 (4 button option)

Electronic Enclosures

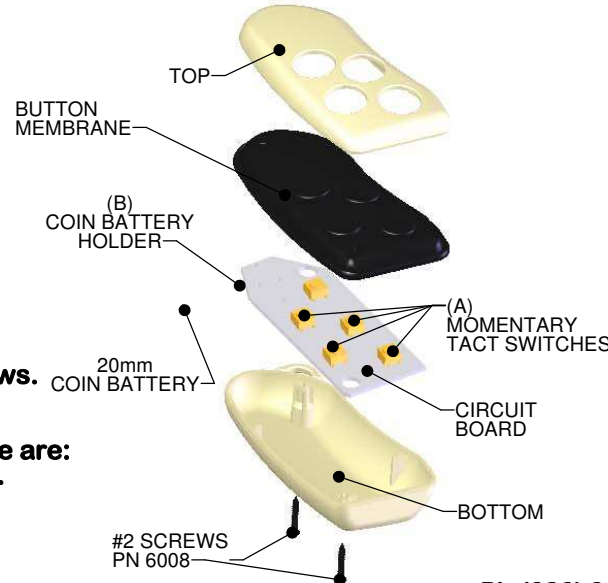
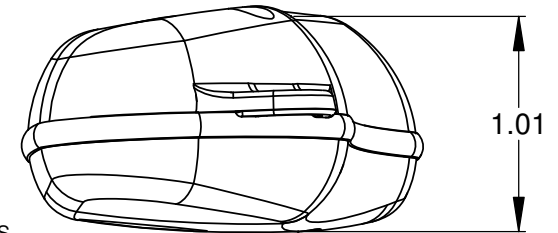
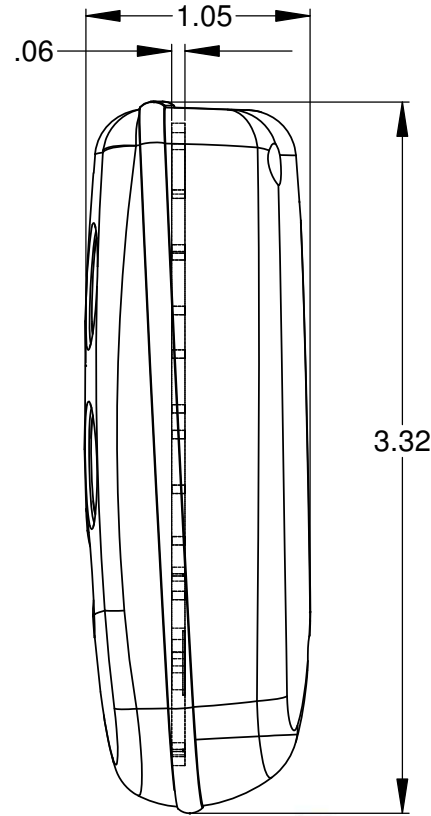
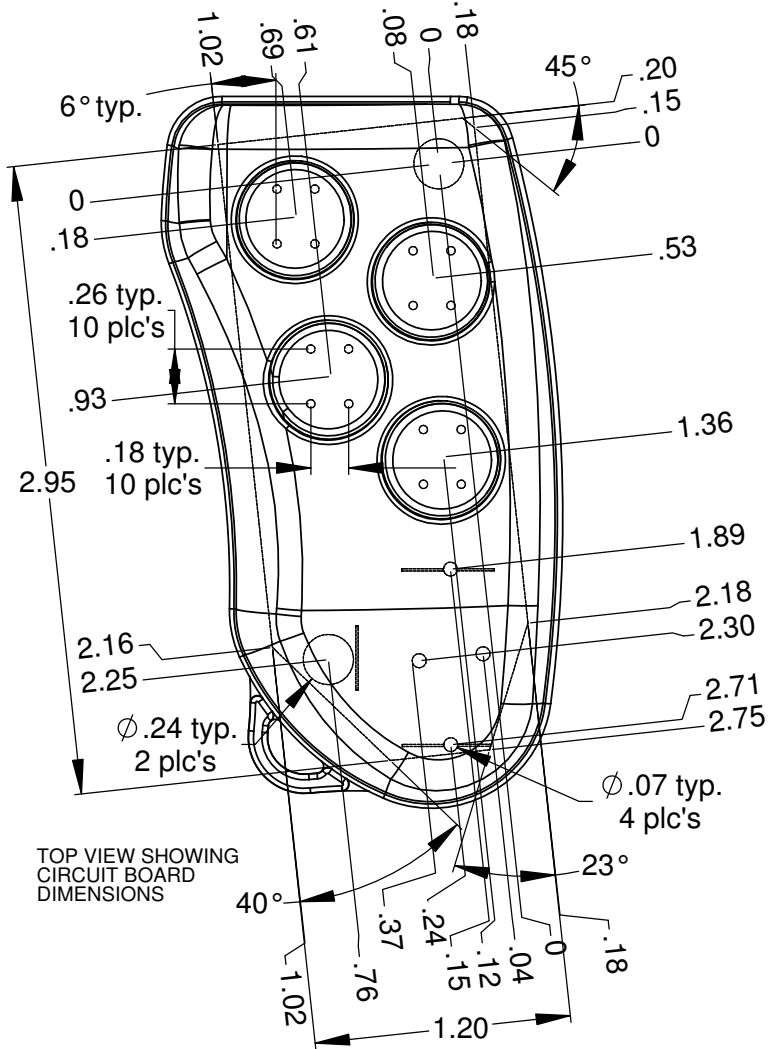

NOTES:

- Serpac Provides the following components:
Top, Bottom, Button Membrane, 9mm keyring and (2) #2 Screws.
All components are shipped unassembled.
- The switches characteristics recommended for this enclosure are:
- 4.3 mm in height from mounting surface to top of push plate.
- Operating force recommended is 1.6 N or more.
- For battery contacts use:
- for Coin battery Keystone 3003 positive and 2990 negative.