

NOTES:

1. $\text{\textcircled{C}}$ REPRESENTS A CRITICAL DIMENSION.
2. ASSEMBLE GOLD PLATED END AS SHOWN.
3. TERMINAL PUSHOUT FORCE: 2 lbs BEFORE HEAT.
4. TERMINALS TO BE FLUSH TO .010[.25] BELOW TOP OF SHROUD.

DO NOT SCALE FROM THIS PRINT

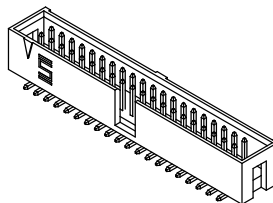

HTST-1XX-01-XX-DV-XX

No OF POSITIONS
-02 THRU -36
(PER ROW)

LEAD STYLE
-01: SURFACE MOUNT
(USE T-1S6-08-X-2)

PLATING SPECIFICATION

- T: TIN (USE T-1S6-08-T-2)
- S: SELECTIVE GOLD (USE T-1S6-08-S-2)
- L: LIGHT SELECTIVE GOLD (USE T-1S6-08-L-2)
- TM: MATTE TIN (USE T-1S6-08-T-2)
- SM: HEAVY SELECTIVE GOLD, MATTE TIN TAIL (USE T-1S6-08-S-2)
- LM: LIGHT SELECTIVE GOLD, MATTE TIN TAIL (USE T-1S6-08-L-2)

OPTION

- A: ALIGNMENT PIN (* ASO OPTION) (SEE FIG. 3 SHT. 2)
- P: PICK & PLACE PAD (USE PPP-22)
- TR: TAPE & REEL (POSITIONS -02 THRU -25 ONLY)

ROW SPECIFICATION

- DV: DOUBLE VERTICAL (USE HTST-XX-D)

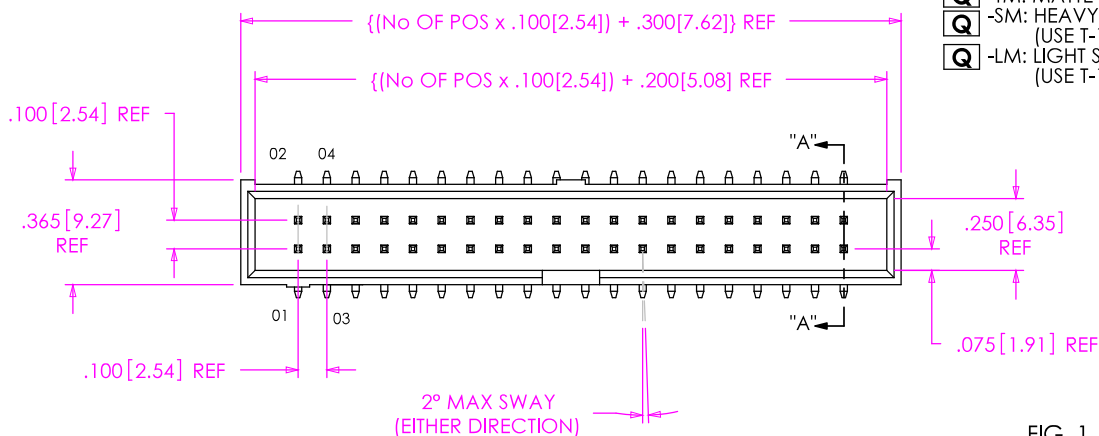

POSITIONS	COPLANARITY
-02 THRU -15	.0040[.102]
-16 THRU -36	.0060[.152]

FIG. 1
HTST-120-01-X-DV SHOWN

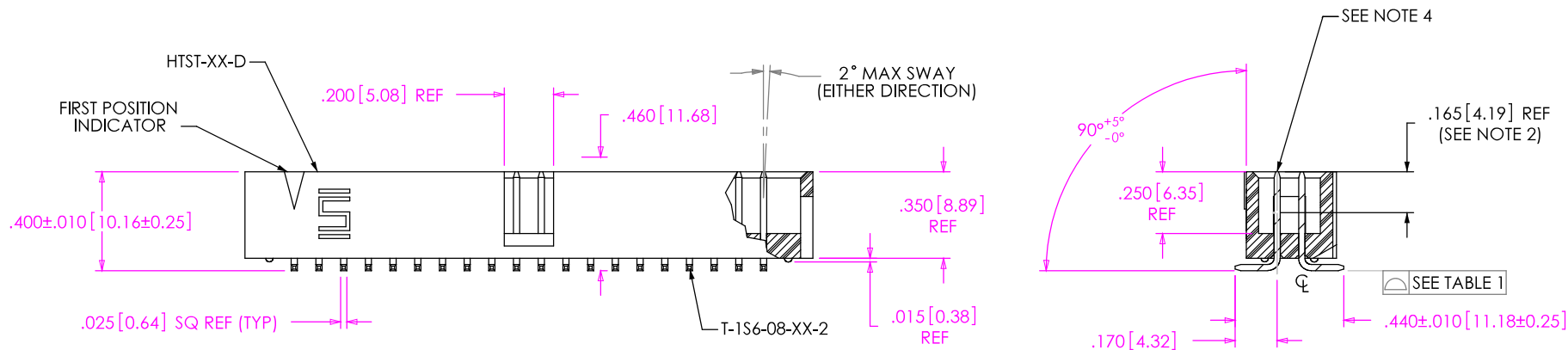

IN-PROCESS VIEW 1

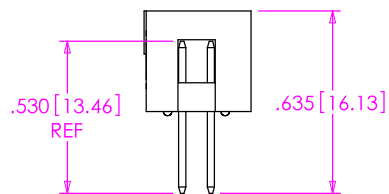

IN-PROCESS VIEW 2

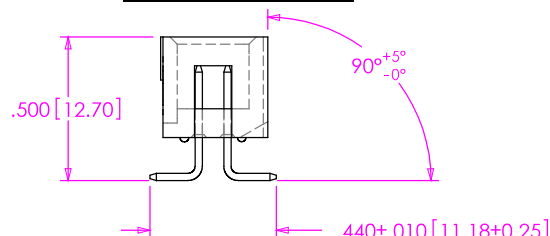

UNLESS OTHERWISE SPECIFIED, DIMENSIONS ARE IN INCHES. TOLERANCES ARE:
DECIMALS ANGLES
.XX: ±.01 [.3] 2°
.XXX: ±.005 [.13]
.XXXX: ±.0020 [.051]

PROPRIETARY NOTE

THIS DOCUMENT CONTAINS INFORMATION CONFIDENTIAL AND PROPRIETARY TO SAMTEC, INC. AND SHALL NOT BE REPRODUCED OR TRANSFERRED TO OTHER DOCUMENTS OR DISCLOSED TO OTHERS OR USED FOR ANY PURPOSE OTHER THAN THAT WHICH IT WAS OBTAINED WITHOUT THE EXPRESSED WRITTEN CONSENT OF SAMTEC, INC.

MATERIAL: DO NOT SCALE DRAWING SHEET SCALE: 1.5:1
INSULATOR: ZYTEL HTNFR52G30NH. COLOR: NATURAL
ALTERNATE MATERIAL: THERMAX CG933
TERMINAL: PHOS BRONZE



SAMTEC

520 PARK EAST BLVD, NEW ALBANY, IN 47150
* PHONE: 812.944.6733 FAX: 812.948.5047
e-Mail: INFO@SAMTEC.COM CODE: 55322

DESCRIPTION: HIGH TEMP TOP SHROUD
DWG. NO. HTST-1XX-01-XX-DV-XX
BY: T. WERNE 07/11/2001 SHEET 1 OF 3

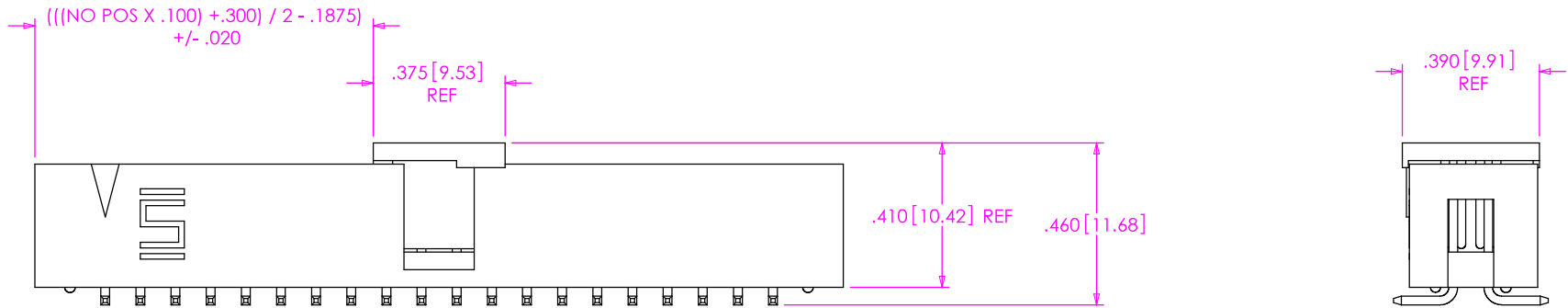

FIG. 2

-P: PICK & PLACE PAD OPTION
(SAME AS FIG. 1 UNLESS OTHERWISE STATED)

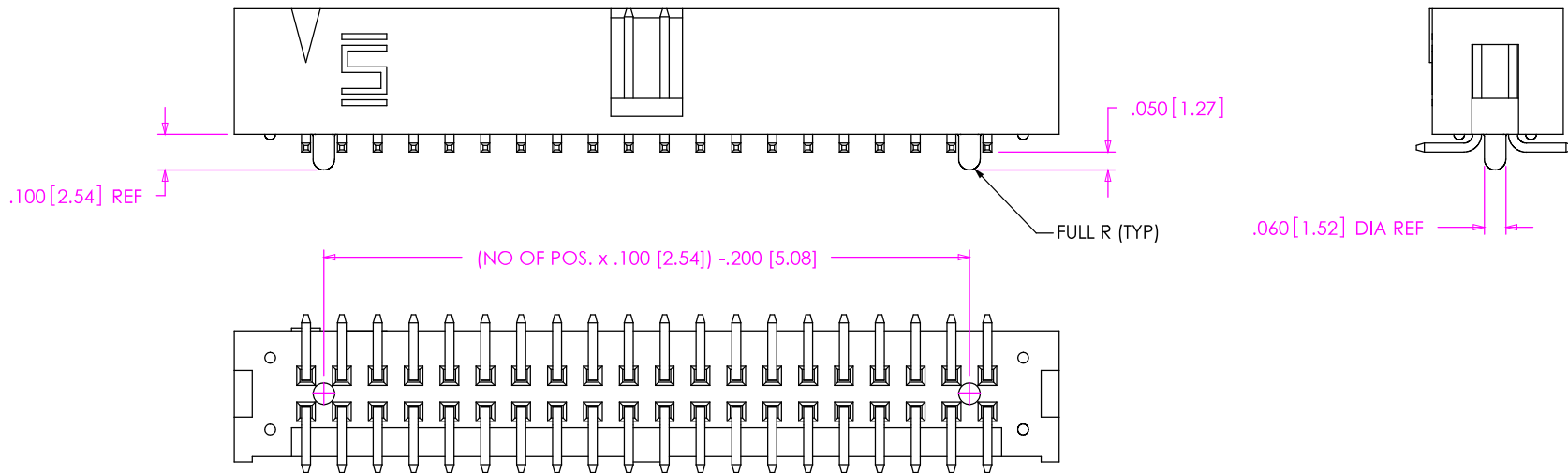

FIG. 3

-A: ALIGNMENT PIN OPTION
(SAME AS FIG. 1 UNLESS OTHERWISE STATED)

PROPRIETARY NOTE
THIS DOCUMENT CONTAINS INFORMATION CONFIDENTIAL AND PROPRIETARY TO SAMTEC, INC. AND SHALL NOT BE REPRODUCED OR TRANSFERRED TO OTHER DOCUMENTS OR DISCLOSED TO OTHERS OR USED FOR ANY PURPOSE OTHER THAN THAT WHICH IT WAS OBTAINED WITHOUT THE EXPRESSED WRITTEN CONSENT OF SAMTEC, INC.

DO NOT SCALE DRAWING

SHEET SCALE: 2:1

SAMTEC

520 Park East Blvd. New Albany, IN 47151
Phone (812) 944-6733 Fax (812) 948-5047
e-Mail: INFO@SAMTEC.COM CODE: 55322

DESCRIPTION: HIGH TEMP TOP SHROUD

DWG. NO. HTST-1XX-01-XX-DV-XX

BY: T. WERNE 07/11/2001 SHEET 2 OF 3

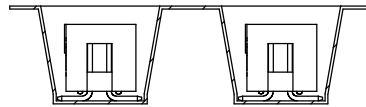
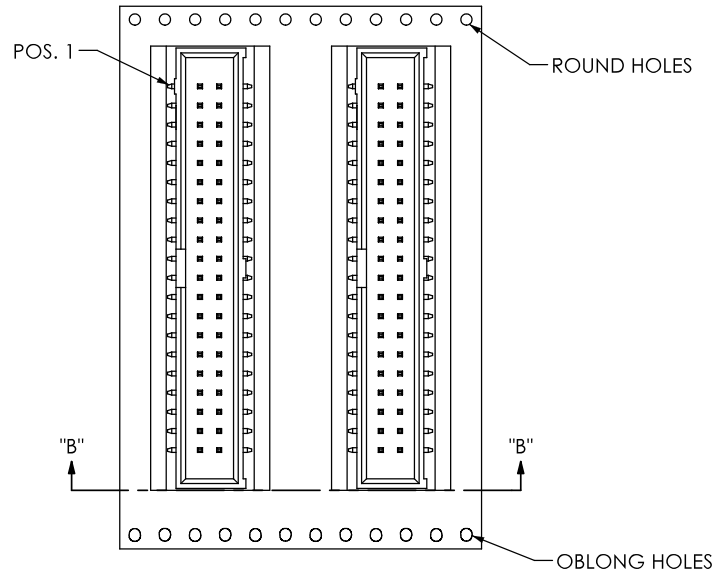

SECTION "B"-B"
SCALE 1:1

USER DIRECTION OF REELING →
POCKET NOT DETAILED

TAPE & REEL VIEW

TUBE VIEW

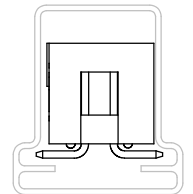

TUBE: PT-1-24-02-08
PLUG: TP-13

PROPRIETARY NOTE
THIS DOCUMENT CONTAINS INFORMATION
CONFIDENTIAL AND PROPRIETARY TO
SAMTEC, INC. AND SHALL NOT BE REPRODUCED
OR TRANSFERRED TO OTHER DOCUMENTS OR
DISCLOSED TO OTHERS OR USED FOR ANY
PURPOSE OTHER THAN THAT WHICH IT WAS
OBTAINED WITHOUT THE EXPRESSED WRITTEN
CONSENT OF SAMTEC, INC.

DO NOT SCALE DRAWING

SHEET SCALE: 2:1

SAMTEC

520 Park East Blvd. New Albany, IN 47151
Phone (812) 944-6733 Fax (812) 948-5047
e-Mail: INFO@SAMTEC.COM CODE: 55322

DESCRIPTION:	HIGH TEMP TOP SHROUD
DWG. NO.	HTST-1XX-01-XX-DV-XX
BY: T. WERNE	07/11/2001 SHEET 3 OF 3