

THIS INFORMATION IS CONFIDENTIAL AND PROPRIETARY TO CW INDUSTRIES INCORPORATED AND ITS AFFILIATES. IT MAY NOT BE DISCLOSED TO ANYONE, OTHER THAN CW INDUSTRIES PERSONNEL, WITHOUT WRITTEN AUTHORIZATION FROM CW INDUSTRIES INCORPORATED, SOUTHAMPTON, PENNSYLVANIA USA.

Rating	6A 125V AC, 3A 250V AC		Mounting Hole		Circuit Diagram
Contact Resistance	50m ohm max.		See Chart		
Insulation Resistance	DC 500V 100M ohm min.				
Dielectric Strength	AC 1000V 1 minute				
Operating Temperature	-25° C ~ 85° C				

Cut-Out 0.75 ~ 3.0 mm thk.

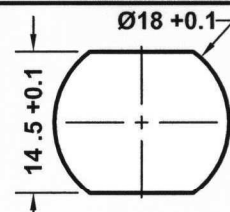
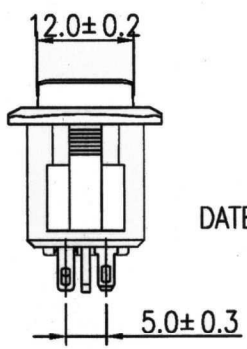
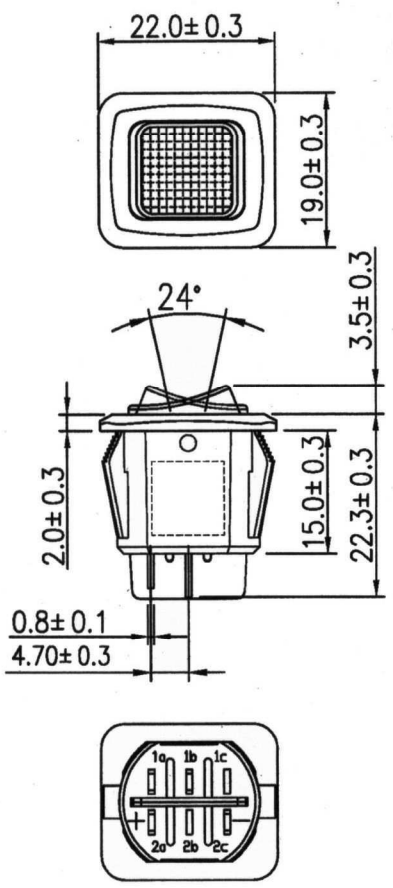

DATE CODE

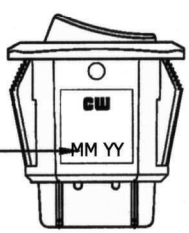

Frames are nylon (UL flame: 94V-2).
Illuminated actuators are molded in PC, available in Red, Amber or Green Colors.
Terminals are silver plated brass.



ROCKER STYLE

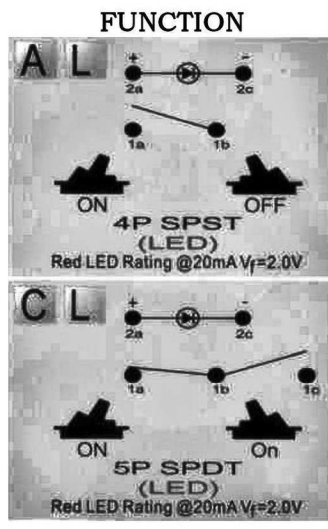
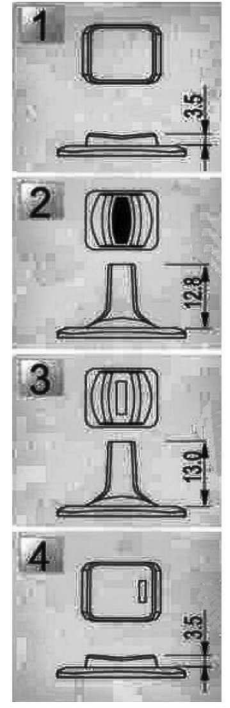

RoHS Compliant

CW INDUSTRIES
Southampton, Pa. 18966
Tel 215.355.7080/www.cwind.com

Date Drawn: 1/21/2011

Rev. 0

Unit: mm

Checked By: G.GULD

Title: **ROCKER SWITCH**

CW P/N: **GRB290XXSERIES**