

### Features

- Radial / Through hole package
- Reliable & robust
- Low power consumption
- Available on tape and reel
- RoHS Compliant

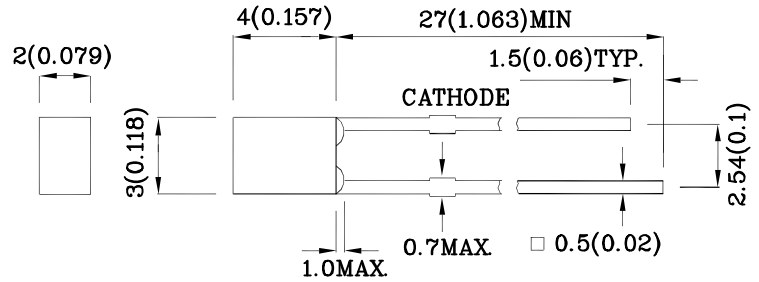

### Package Schematics



Notes:

1. All dimensions are in millimeters (inches).
2. Tolerance is  $\pm 0.25(0.01)$  unless otherwise noted.
3. Specifications are subject to change without notice.

Absolute Maximum Ratings ( $T_A=25^\circ\text{C}$ )		US (GaAsP/GaP)	Unit
Reverse Voltage	$V_R$	5	V
Forward Current	$I_F$	25	mA
Forward Current (Peak) 1/10 Duty Cycle 0.1ms Pulse Width	$i_{FS}$	145	mA
Power Dissipation	$P_D$	62.5	mW
Operating Temperature	$T_A$	-40 ~ +85	°C
Storage Temperature	$T_{stg}$	-40 ~ +85	
Lead Solder Temperature [2mm Below Package Base]	260°C For 3 Seconds		
Lead Solder Temperature [5mm Below Package Base]	260°C For 5 Seconds		

Operating Characteristics ( $T_A=25^\circ\text{C}$ )		US (GaAsP/GaP)	Unit
Forward Voltage (Typ.) ( $I_F=10\text{mA}$ )	$V_F$	1.95	V
Forward Voltage (Max.) ( $I_F=10\text{mA}$ )	$V_F$	2.5	V
Reverse Current (Max.) ( $V_R=5\text{V}$ )	$I_R$	10	$\mu\text{A}$
Wavelength of Peak Emission CIE127-2007* (Typ.) ( $I_F=10\text{mA}$ )	$\lambda_P$	607 607*	nm
Wavelength of Dominant Emission CIE127-2007* (Typ.) ( $I_F=10\text{mA}$ )	$\lambda_D$	610 602*	nm
Spectral Line Full Width At Half-Maximum (Typ.) ( $I_F=10\text{mA}$ )	$\Delta\lambda$	35	nm
Capacitance (Typ.) ( $V_F=0\text{V}$ , $f=1\text{MHz}$ )	C	15	pF

Part Number	Emitting Color	Emitting Material	Lens-color	Luminous Intensity CIE127-2007* ( $I_F=10\text{mA}$ ) mcd		Wavelength CIE127-2007* nm $\lambda_P$	Viewing Angle 2 $\theta$ 1/2
				min.	typ.		
XSUS36D	Orange	GaAsP/GaP	Orange Diffused	3 1.2*	6 3*	607*	100°

\*Luminous intensity value and wavelength are in accordance with CIE127-2007 standards.

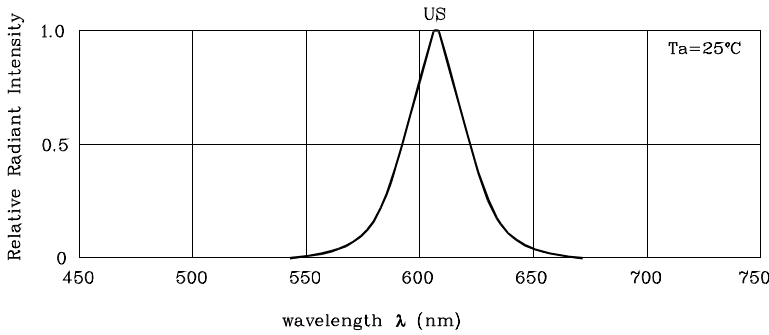

RELATIVE INTENSITY Vs. CIE WAVELENGTH

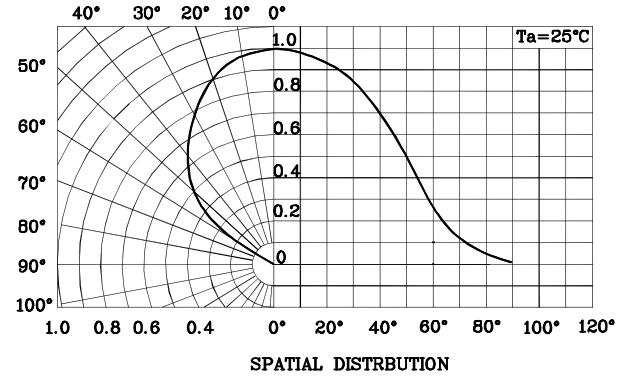

❖ US

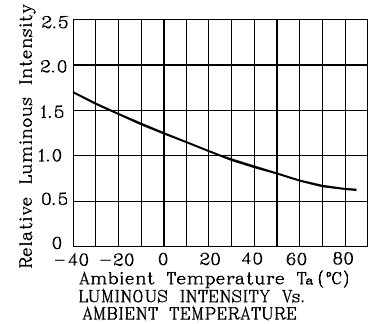
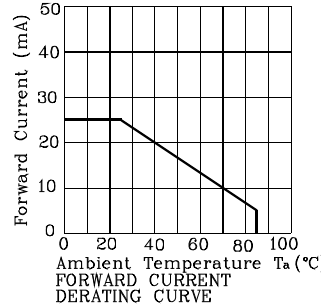
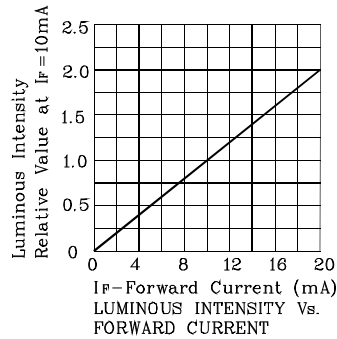
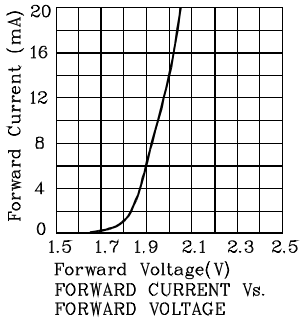

Wave Soldering Profile For Thru-Hole Products (Pb-Free Components)

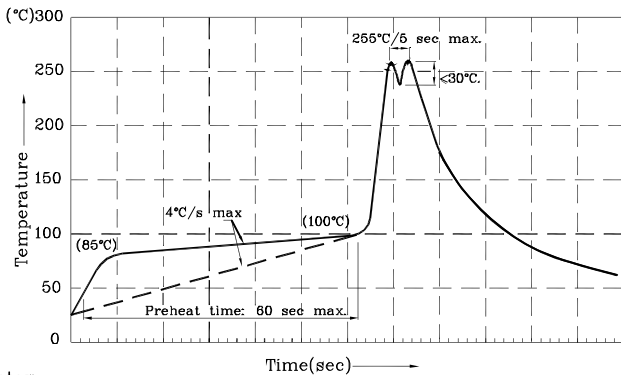

- Notes:
1. Recommend pre-heat temperature of 105°C or less (as measured with a thermocouple attached to the LED pins) prior to immersion in the solder wave with a maximum solder bath temperature of 280°C
  2. Peak wave soldering temperature between 245°C ~ 255°C for 3 sec (5 sec max).
  3. Do not apply stress to the epoxy resin while the temperature is above 85°C.
  4. Fixtures should not incur stress on the component when mounting and during soldering process.
  5. SAC 305 solder alloy is recommended.
  6. No more than one wave soldering pass.



Remarks:



If special sorting is required (e.g. binning based on forward voltage, luminous intensity / luminous flux, or wavelength), the typical accuracy of the sorting process is as follows:

1. Wavelength: +/-1nm
2. Luminous Intensity / Luminous Flux: +/-15%
3. Forward Voltage: +/-0.1V

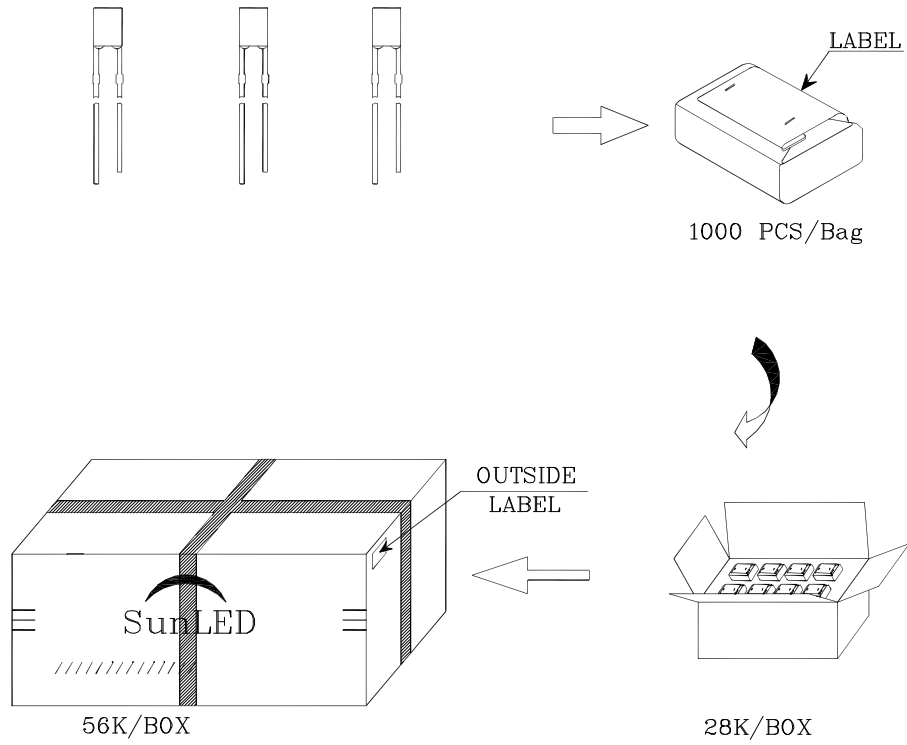
Note: Accuracy may depend on the sorting parameters.

PACKING & LABEL SPECIFICATIONS

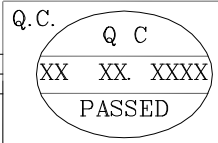
	
P/NO : XSxx36x	FQC
QTY : 1000 pcs	CODE: XXX
S/N : XX	
LOT NO:  XXXXXXXXXXXXXXXXXXXXXXXX	
RoHS Compliant	