

Features

- BUILT-IN CURRENT LIMITING RESISTOR FOR DIRECT APPLICATION OF DIFFERENT ACROSS CURRENT.
- LONG LIFE.
- LOW CURRENT, POWER SAVINGS.
- LOW MAINTENANCE.
- SOLID STATE, HIGH VIBRATION RESISTANT.
- 28V INTERNAL RESISTOR.
- RoHS COMPLIANT.



Notes:

1. All dimensions are in millimeters (inches).
2. Tolerance is $\pm 0.25(0.01)$ " unless otherwise noted.
3. Specifications are subject to change without notice.

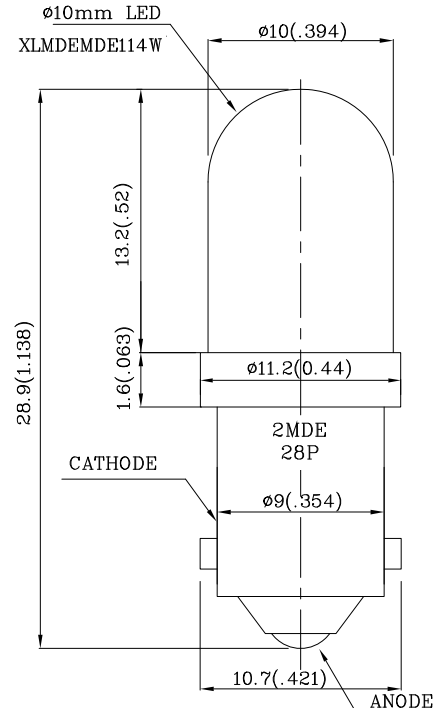

Absolute Maximum Ratings ($T_A=25^\circ\text{C}$)		MD-E (InGaAlP)	Unit
Reverse Voltage	V_R	5	V
Forward Voltage	V_F	30	V
Power Dissipation	P_T	450	mW
Operating Temperature	T_A	-40 ~ +70	°C
Storage Temperature	T_{stg}	-40 ~ +85	

Operating Characteristics ($T_A=25^\circ\text{C}$)		MD-E (InGaAlP)	Unit
Forward Current (Typ.) ($V_F=28\text{V}$)	I_F	12	mA
Forward Current (Max.) ($V_F=28\text{V}$)	I_F	15	mA
Reverse Current (Max.) ($V_R=5\text{V}$)	I_R	10	μA
Wavelength Of Peak Emission (Typ.) ($V_F=28\text{V}$)	λ_P	640	nm
Wavelength Of Dominant Emission (Typ.) ($V_F=28\text{V}$)	λ_D	630	nm
Spectral Line Full Width At Half-Maximum (Typ.) ($V_F=28\text{V}$)	$\Delta\lambda$	25	nm

Part Number	Emitting Color	Emitting Material	Lens-color	Luminous Intensity ($V=28\text{V}$) mcd		Wavelength nm λ_P	Viewing Angle $2\theta_{1/2}$
				min.	typ.		
XYMDE102W28V	Red	InGaAlP	Water Clear	480	1295	640	40°

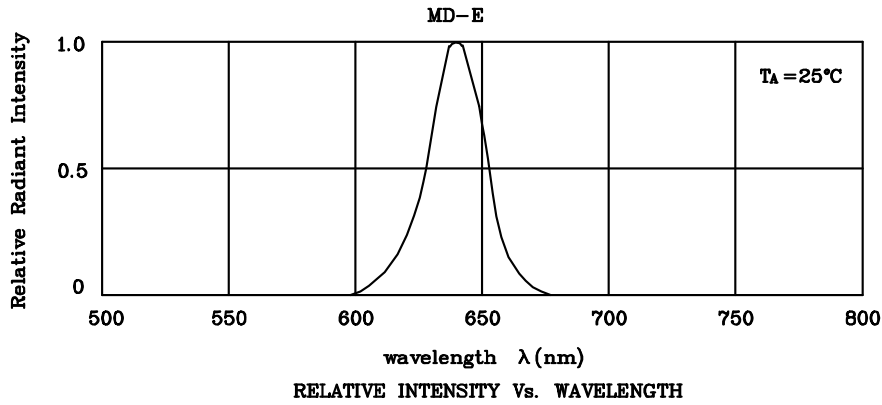

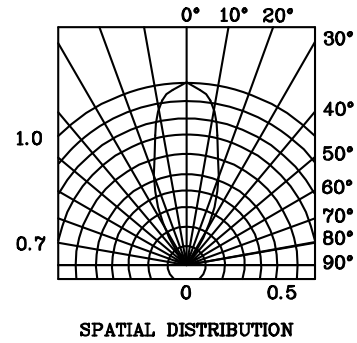
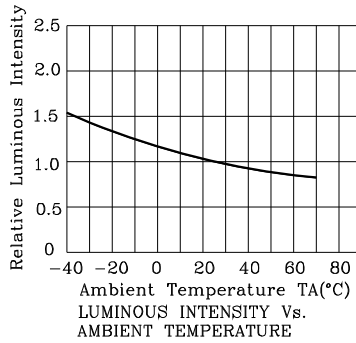
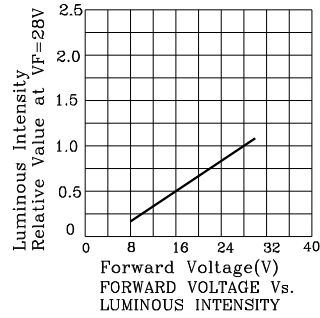
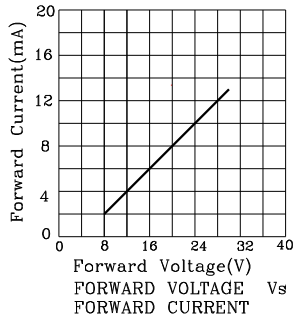

❖ MD-E

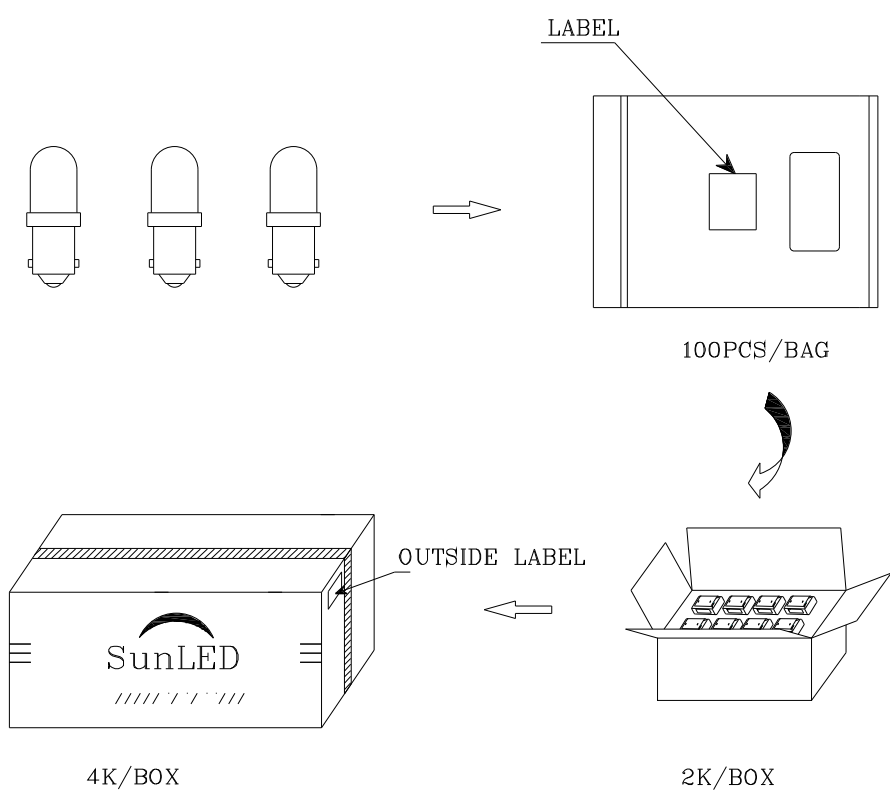

PACKING & LABEL SPECIFICATIONS

XYMDE102W28V

P/NO : XYxxx102x	
QTY : 100 pcs	CODE: XXX
S/N : XX	
LOT NO :	
 XXXXXXXXXXXXXXXXXXXXXXXX	
RoHS Compliant	