

Features

- Low power consumption
- Robust package
- I.C. Compatible
- Standard configuration: Gray face w/ white segments
- Optional black face provides superior color contrast
- RoHS Compliant

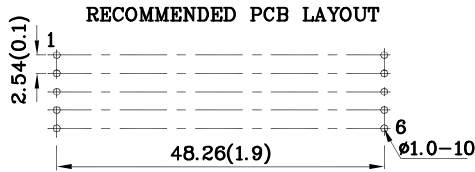

Package Schematics

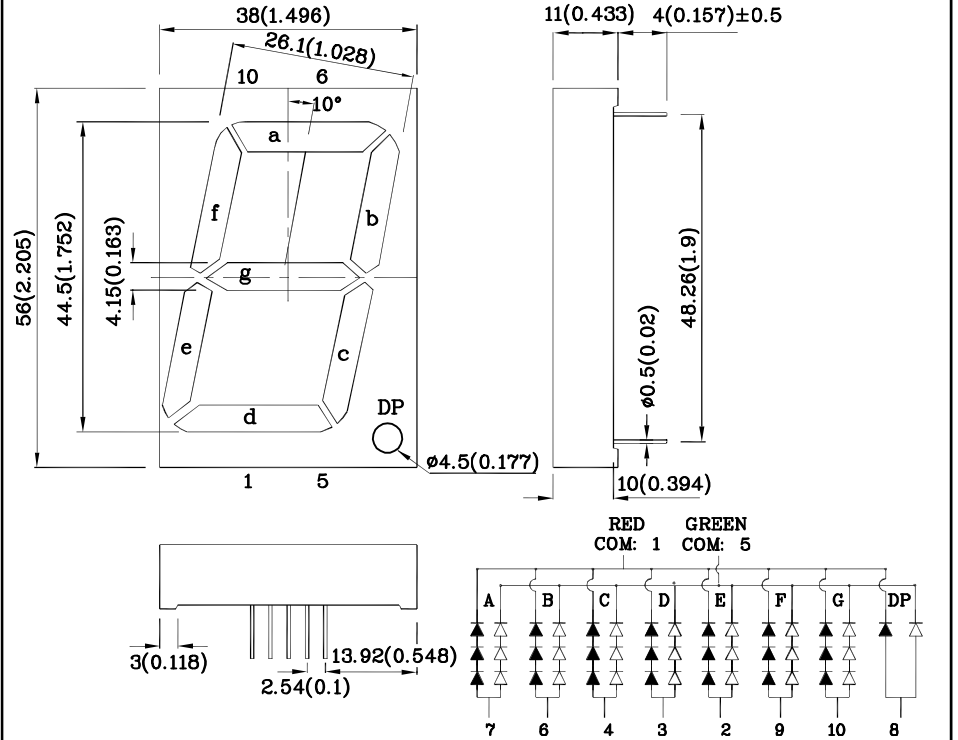

Notes:

1. All dimensions are in millimeters (inches), Tolerance is ±0.25(0.01") unless otherwise noted.
2. Specifications are subject to change without notice.

Absolute Maximum Ratings (T _A =25°C)		UR (GaAsP/GaP)	UG (GaP)	Unit
Reverse Voltage Per Segment Or (Dp)	V _R	5	5	V
Forward Current Per Segment Or (Dp)	I _F	30	25	mA
Forward Current (Peak) 1/10 Duty Cycle 0.1ms Pulse Width Per Segment Or (Dp)	i _{FS}	160	140	mA
Power Dissipation Per Segment Or (Dp)	P _D	225 (75)	187.5 (62.5)	mW
Operating Temperature	T _A	-40 ~ +85		°C
Storage Temperature	T _{stg}	-40 ~ +85		
Lead Solder Temperature [2mm Below Package Base]	260°C For 3-5 Seconds			

Operating Characteristics (T _A =25°C)		UR (GaAsP/GaP)	UG (GaP)	Unit
Forward Voltage (Typ.) (I _F =10mA) Per Segment Or (Dp)	V _F	5.7 (1.9)	6.0 (2.0)	V
Forward Voltage (Max.) (I _F =10mA) Per Segment Or (Dp)	V _F	7.5 (2.5)	7.5 (2.5)	V
Reverse Current (Max.) (V _R =5V) Per Segment Or (Dp)	I _R	10	10	uA
Wavelength of Peak Emission (Typ.) (I _F =10mA)	λ _P	627	565	nm
Wavelength of Dominant Emission (Typ.) (I _F =10mA)	λ _D	625	568	nm
Spectral Line Full Width At Half-Maximum (Typ.) (I _F =10mA)	Δλ	45	30	nm
Capacitance (Typ.) (V _F =0V, f=1MHz)	C	15	15	pF

Part Number	Emitting Color	Emitting Material	Luminous Intensity (I _F =10mA) ucd		Wavelength nm λ _P	Description
			min.	typ.		
XDURG46C	Red	GaAsP/GaP	21000	42990	627	Common Cathode, Rt.Hand Decimal.
	Green	GaP	21000	49990	565	

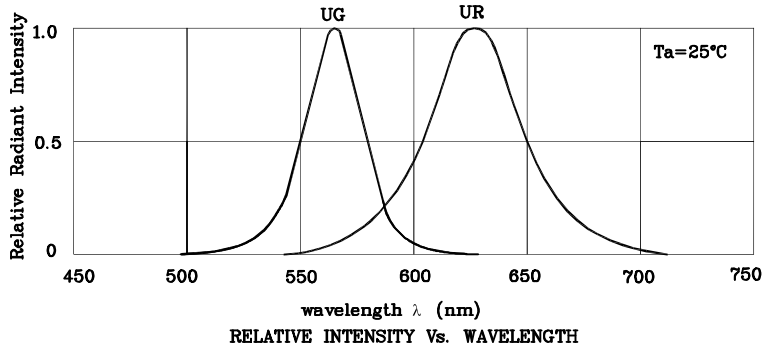

❖ UR

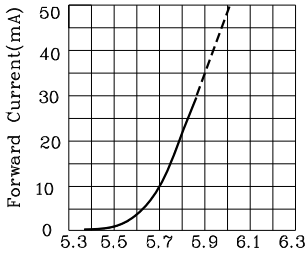

Forward Voltage(V)
FORWARD CURRENT Vs.
FORWARD VOLTAGE

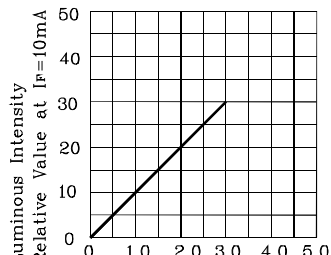

If-Forward Current (mA)
LUMINOUS INTENSITY Vs.
FORWARD CURRENT

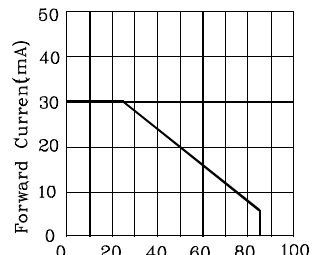

Ambient Temperature Ta(°C)
FORWARD CURRENT
DERATING CURVE

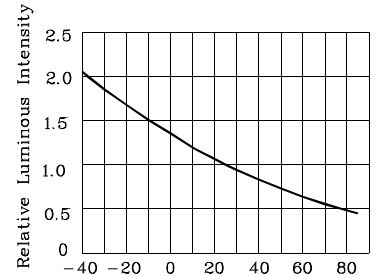

Ambient Temperature Ta(°C)
LUMINOUS INTENSITY Vs.
AMBIENT TEMPERATURE

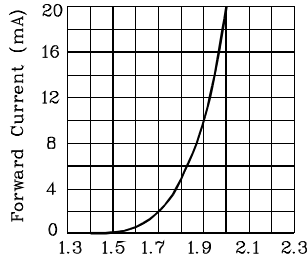

Forward Voltage(V)
FORWARD CURRENT Vs.
FORWARD VOLTAGE

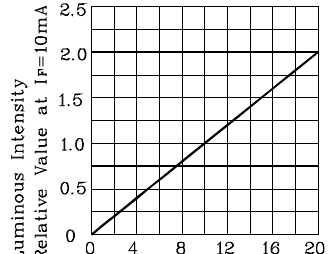

If-Forward Current (mA)
LUMINOUS INTENSITY Vs.
FORWARD CURRENT

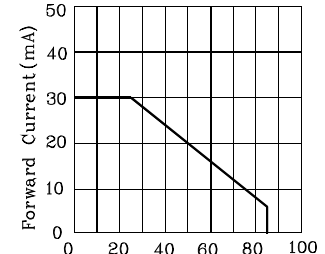

Ambient Temperature Ta(°C)
FORWARD CURRENT
DERATING CURVE

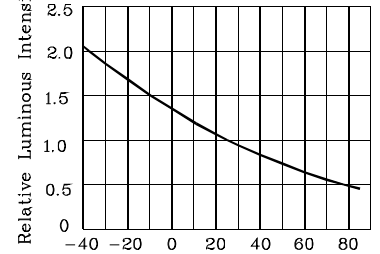

Ambient Temperature Ta(°C)
LUMINOUS INTENSITY Vs.
AMBIENT TEMPERATURE

❖ UG

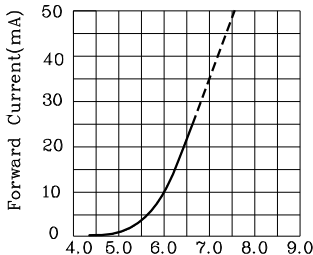

Forward Voltage(V)
FORWARD CURRENT Vs.
FORWARD VOLTAGE

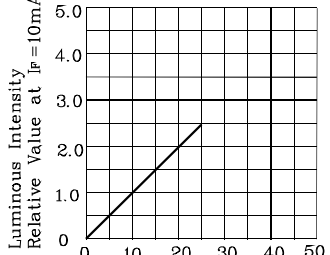

If-Forward Current (mA)
LUMINOUS INTENSITY Vs.
FORWARD CURRENT

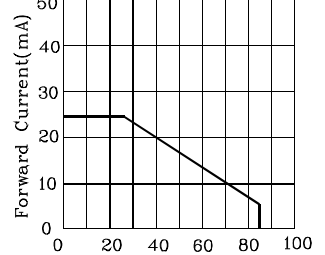

Ambient Temperature Ta(°C)
FORWARD CURRENT
DERATING CURVE

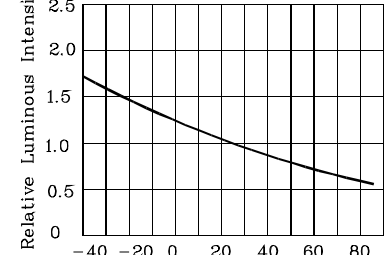

Ambient Temperature Ta(°C)
LUMINOUS INTENSITY Vs.
AMBIENT TEMPERATURE

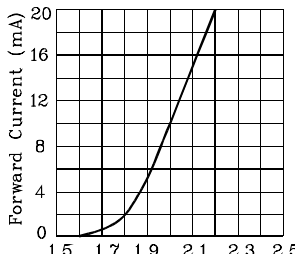

Forward Voltage(V)
FORWARD CURRENT Vs.
FORWARD VOLTAGE

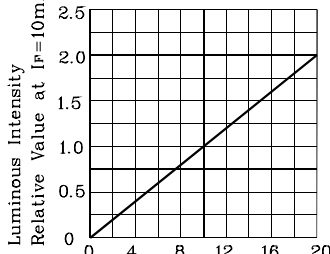

If-Forward Current (mA)
LUMINOUS INTENSITY Vs.
FORWARD CURRENT

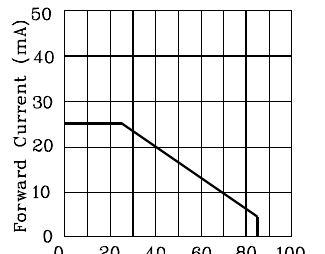

Ambient Temperature Ta(°C)
FORWARD CURRENT
DERATING CURVE

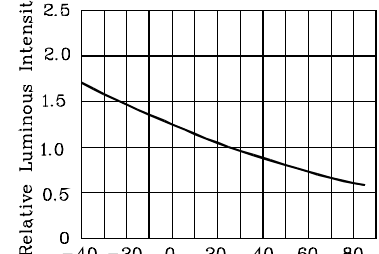

Ambient Temperature Ta(°C)
LUMINOUS INTENSITY Vs.
AMBIENT TEMPERATURE

Wave Soldering Profile for Thru-Hole Products (Pb-Free Components)

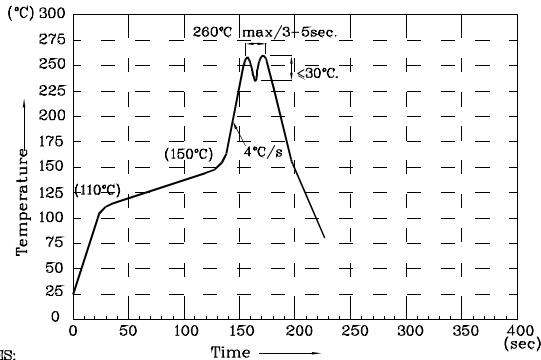

- NOTES:
1. Recommend the wave temperature 245°C~260°C. The maximum soldering temperature should be less than 260°C.
 2. Do not apply stress on epoxy resins when temperature is over 85°C.
 3. The soldering profile apply to the lead free soldering (Sn/Cu/Ag alloy).
 4. During wave soldering, the PCB top-surface temperature should be kept below 105°C.
 5. No more than once.

Remarks:

If special sorting is required (e.g. binning based on forward voltage, luminous intensity / luminous flux, or wavelength), the typical accuracy of the sorting process is as follows:

1. Wavelength: +/-1nm
2. Luminous Intensity / Luminous Flux: +/-15%
3. Forward Voltage: +/-0.1V

Note: Accuracy may depend on the sorting parameters.

PACKING & LABEL SPECIFICATIONS

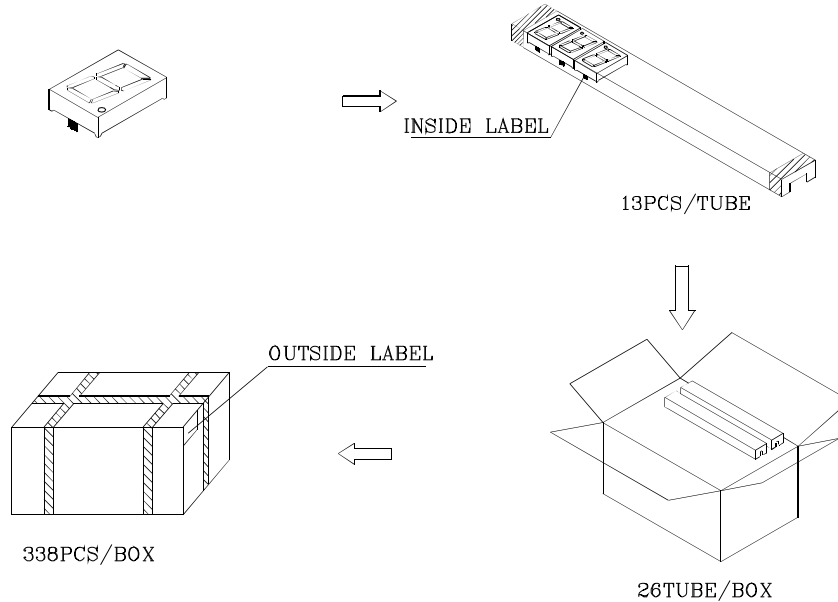

Inside Label On IC-tube

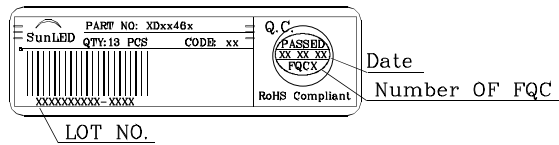

Outside Label On Box

