

**Features**

- 1.5 INCH DIGIT HEIGHT.
- LOW CURRENT OPERATION.
- EXCELLENT CHARACTER APPEARANCE.
- HIGH LIGHT OUTPUT.
- EASY MOUNTING ON P.C. BOARDS OR SOCKETS.
- I.C. COMPATIBLE.
- MECHANICALLY RUGGED.
- STANDARD : GRAY FACE, WHITE SEGMENT.
- RoHS COMPLIANT.

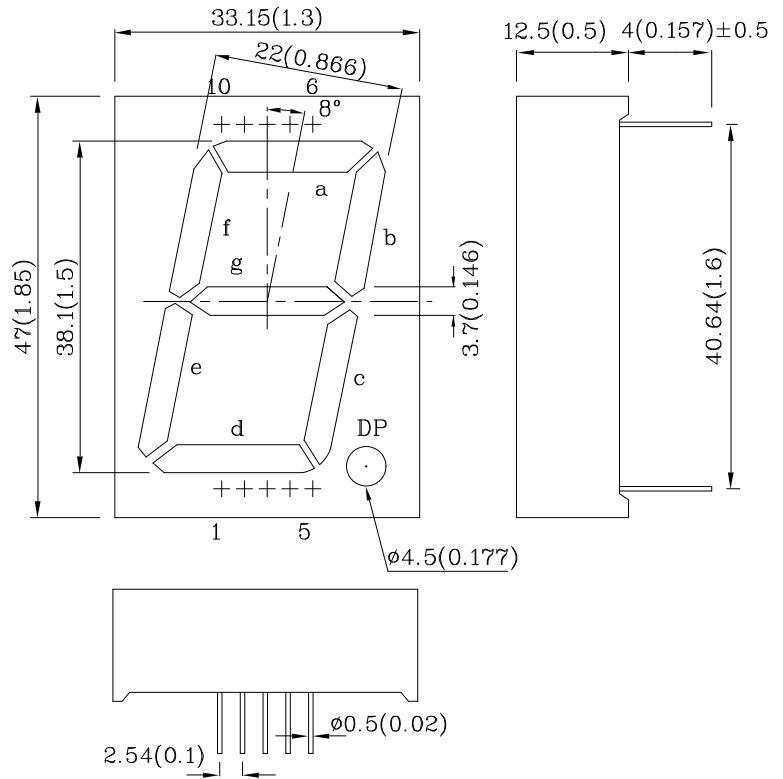
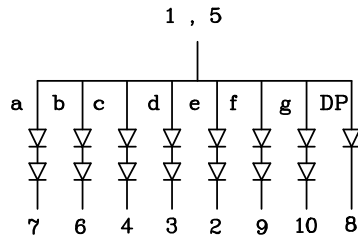

Notes:

1. All dimensions are in millimeters (inches).
2. Tolerance is ± 0.25(0.01") unless otherwise noted.
3. Specifications are subject to change without notice.

Absolute Maximum Ratings (TA=25°C)		UY (GaAsP/GaP)	Unit
Reverse Voltage Per Segment or (Dp)	V <sub>R</sub>	10(5)	V
Forward Current Per Segment or (Dp)	I <sub>F</sub>	30(30)	mA
Forward Current (Peak) 1/10 Duty Cycle 0.1ms Pulse Width Per Segment or (Dp)	i <sub>FS</sub>	140(140)	mA
Power Dissipation Per Segment or (Dp)	P <sub>T</sub>	150(75)	mW
Operating Temperature	T <sub>A</sub>	-40 ~ +85	°C
Storage Temperature	T <sub>stg</sub>	-40 ~ +85	
Lead Solder Temperature [2mm Below Package Base]	260°C For 3-5 Seconds		

Operating Characteristics (TA=25°C)		UY (GaAsP/GaP)	Unit
Forward Voltage (Typ.) (I <sub>F</sub> =10mA) Per Segment or (Dp)	V <sub>F</sub>	3.9(1.95)	V
Forward Voltage (Max.) (I <sub>F</sub> =10mA) Per Segment or (Dp)	V <sub>F</sub>	5.0(2.5)	V
Reverse Current (V <sub>R</sub> =10V(5V)) Per Segment or (Dp)	I <sub>R</sub>	10 (10)	uA
Wavelength of Peak Emission (I <sub>F</sub> =10mA)	λ <sub>P</sub>	590	nm
Wavelength of Dominant Emission (I <sub>F</sub> =10mA)	λ <sub>D</sub>	588	nm
Spectral Line Full Width At Half-Maximum (I <sub>F</sub> =10mA)	Δλ	35	nm
Capacitance (V <sub>F</sub> =0V, f=1MHz)	C	20	pF

Part Number	Emitting Color	Emitting Material	Luminous Intensity (IF=10mA) ucd		Wavelength nm $\lambda$ P	Description
			min.	typ.		
XDUY38A	Yellow	GaAsP/GaP	1900	7990	590	Common Anode, Rt. Hand Decimal

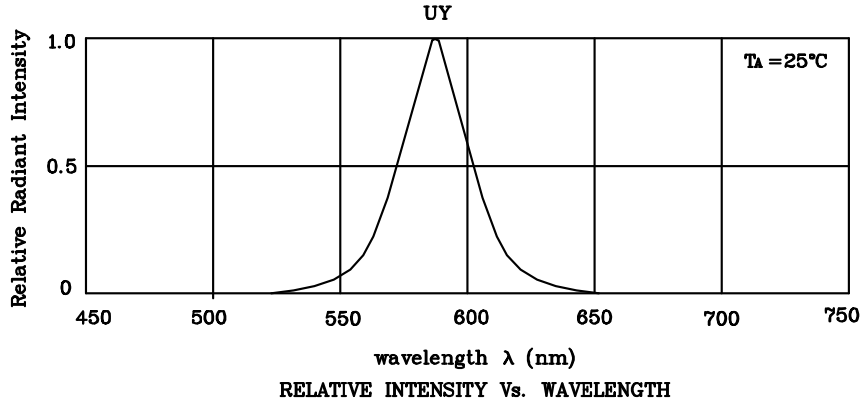

❖ **UY**

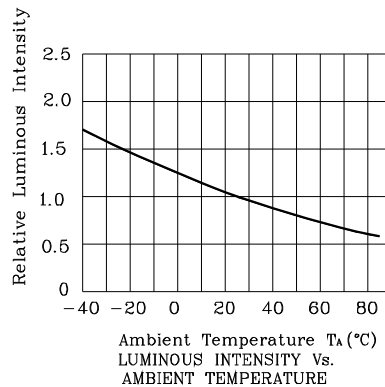
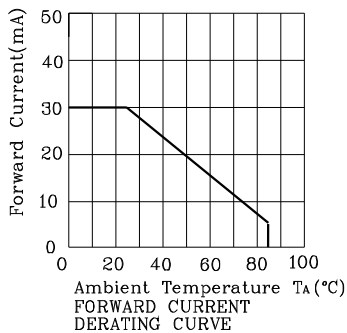
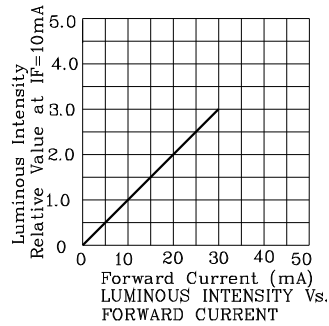
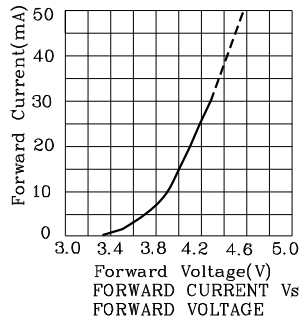

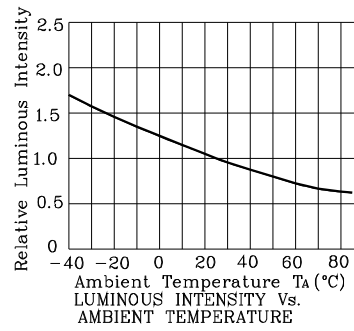
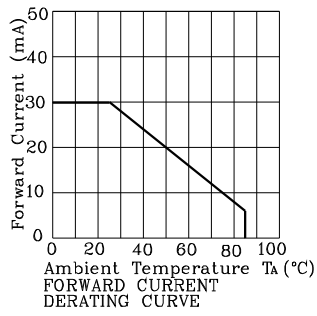
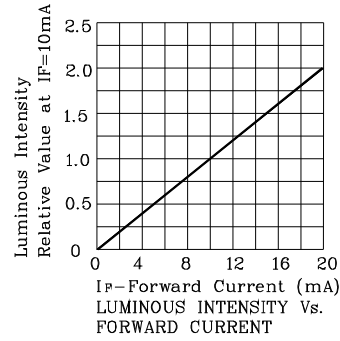
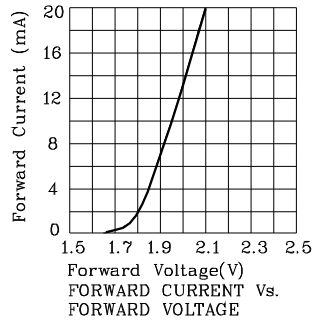

Wave Soldering Profile For Lead-free Through-hole LED.

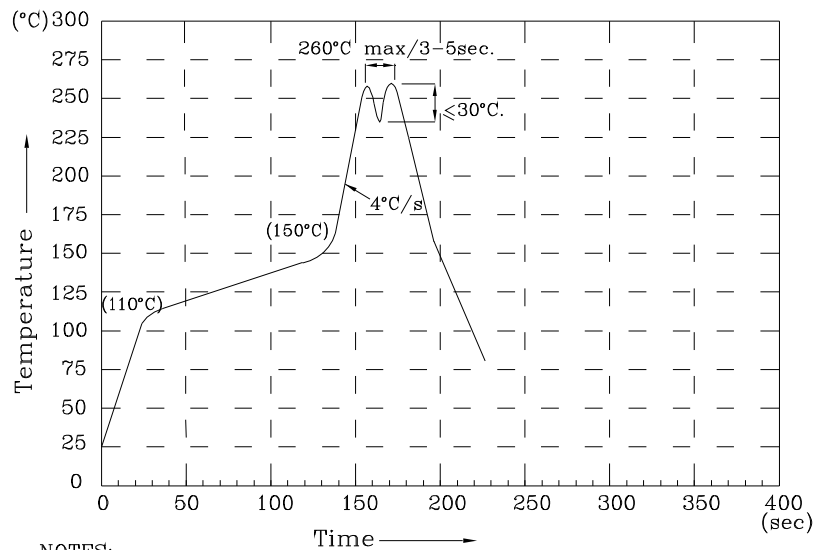

NOTES:

- 1.Recommend the wave temperature 245°C~260°C.The maximum soldering temperature should be less than 260°C.
- 2.Do not apply stress on epoxy resins when temperature is over 85 degree°C.
- 3.The soldering profile apply to the lead free soldering (Sn/Cu/Ag alloy).
- 4.No more than once.

Remarks:

If special sorting is required (e.g. binning based on forward voltage, luminous intensity/ luminous flux or wavelength), the typical accuracy of the sorting process is as follows:

1. Wavelength: +/-1nm
2. Luminous Intensity/ luminous flux: +/-15%
3. Forward Voltage: +/-0.1V

Note: Accuracy may depend on the sorting parameters.

**PACKING & LABEL SPECIFICATIONS**

**XDUY38A**

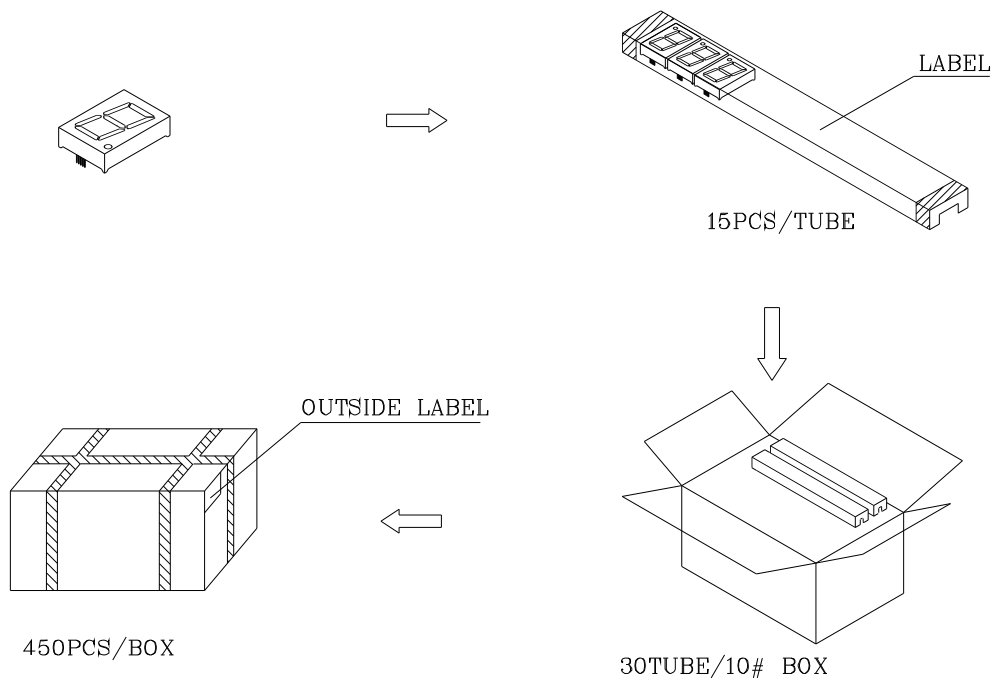

Inside LABEL Paste On The IC-tube

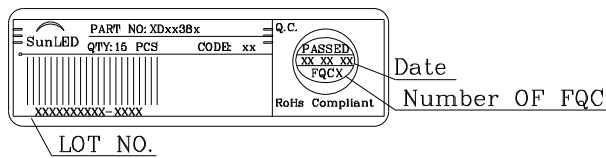

Outside LABEL Paste On The Box

