

Features

- Low power consumption
- Robust package
- I.C. Compatible
- Standard configuration: Gray face w/ white segments
- Optional black face provides superior color contrast
- RoHS Compliant

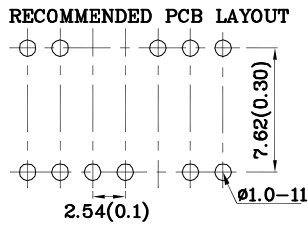

Package Schematics

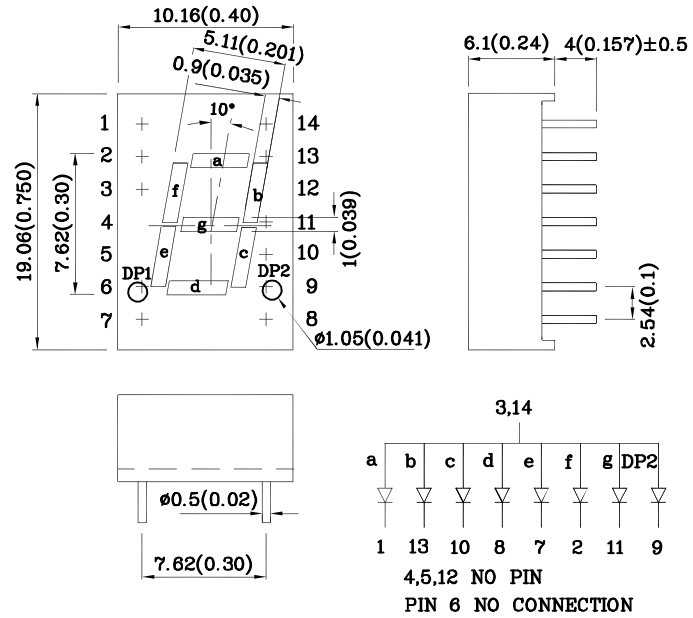

Notes:

1. All dimensions are in millimeters (inches), Tolerance is ±0.25(0.01") unless otherwise noted.
2. Specifications are subject to change without notice.

| Absolute Maximum Ratings (T _A =25°C) | | MR (GaAlAs) | Unit |
|--|-----------------------|-------------|------|
| Reverse Voltage | V _R | 5 | V |
| Forward Current | I _F | 30 | mA |
| Forward Current (Peak) 1/10 Duty Cycle 0.1ms Pulse Width | i _{FS} | 155 | mA |
| Power Dissipation | P _D | 75 | mW |
| Operating Temperature | T _A | -40 ~ +85 | °C |
| Storage Temperature | T _{stg} | -40 ~ +85 | |
| Lead Solder Temperature [2mm Below Package Base] | 260°C For 3-5 Seconds | | |

| Operating Characteristics (T _A =25°C) | | MR (GaAlAs) | Unit |
|---|----------------|-------------|------|
| Forward Voltage (Typ.) (I _F =10mA) | V _F | 1.8 | V |
| Forward Voltage (Max.) (I _F =10mA) | V _F | 2.5 | V |
| Reverse Current (Max.) (V _R =5V) | I _R | 10 | uA |
| Wavelength of Peak Emission (Typ.) (I _F =10mA) | λ _P | 660 | nm |
| Wavelength of Dominant Emission (Typ.) (I _F =10mA) | λ _D | 640 | nm |
| Spectral Line Full Width At Half-Maximum (Typ.) (I _F =10mA) | Δλ | 20 | nm |
| Capacitance (Typ.) (V _F =0V, f=1MHz) | C | 45 | pF |

| Part Number | Emitting Color | Emitting Material | Luminous Intensity (I _F =10mA) | | Wavelength nm λ _P | Description |
|-------------|----------------|-------------------|---|-------|------------------------------|---------------------------------|
| | | | min. | typ. | | |
| XDMR07A | Red | GaAlAs | 21000 | 41990 | 660 | Common Anode, Rt. Hand Decimal. |

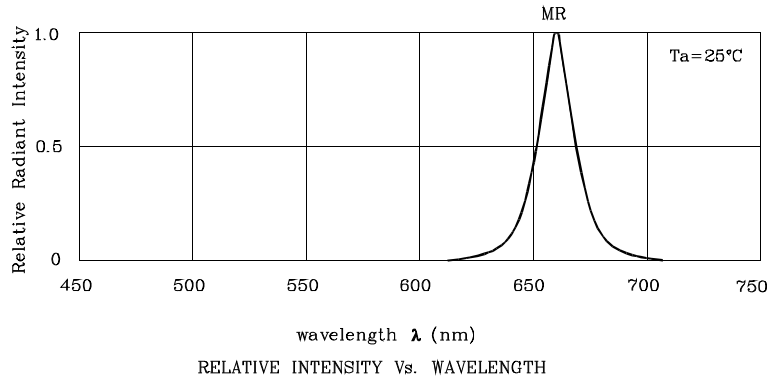

❖ MR

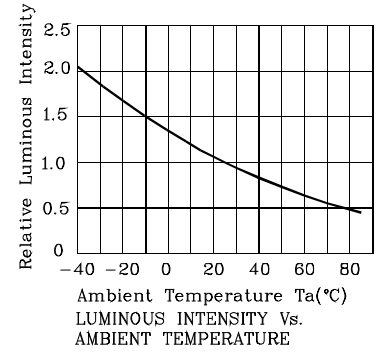
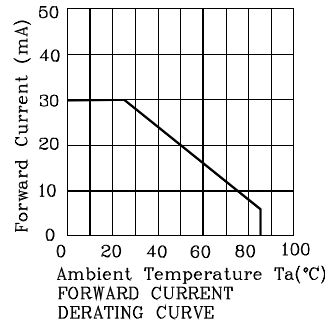
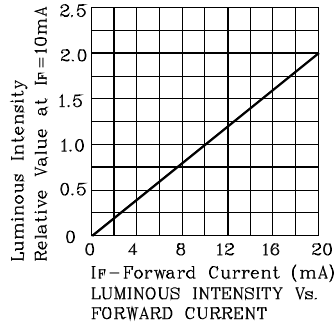
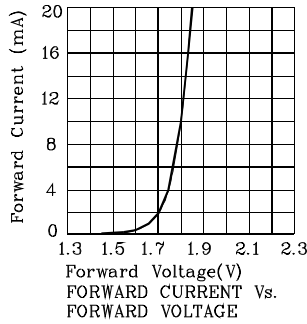

Wave Soldering Profile for Thru-Hole Products (Pb-Free Components)

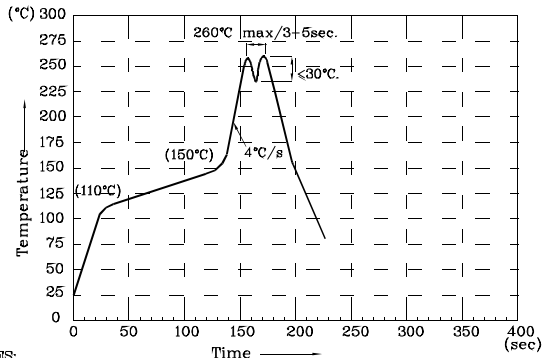

- NOTES:
1. Recommend the wave temperature 245°C~260°C. The maximum soldering temperature should be less than 260°C.
 2. Do not apply stress on epoxy resins when temperature is over 85°C.
 3. The soldering profile apply to the lead free soldering (Sn/Cu/Ag alloy).
 4. During wave soldering, the PCB top-surface temperature should be kept below 105°C.
 5. No more than once.

Remarks:

If special sorting is required (e.g. binning based on forward voltage, luminous intensity / luminous flux, or wavelength), the typical accuracy of the sorting process is as follows:

1. Wavelength: +/-1nm
2. Luminous Intensity / Luminous Flux: +/-15%
3. Forward Voltage: +/-0.1V

Note: Accuracy may depend on the sorting parameters.

PACKING & LABEL SPECIFICATIONS

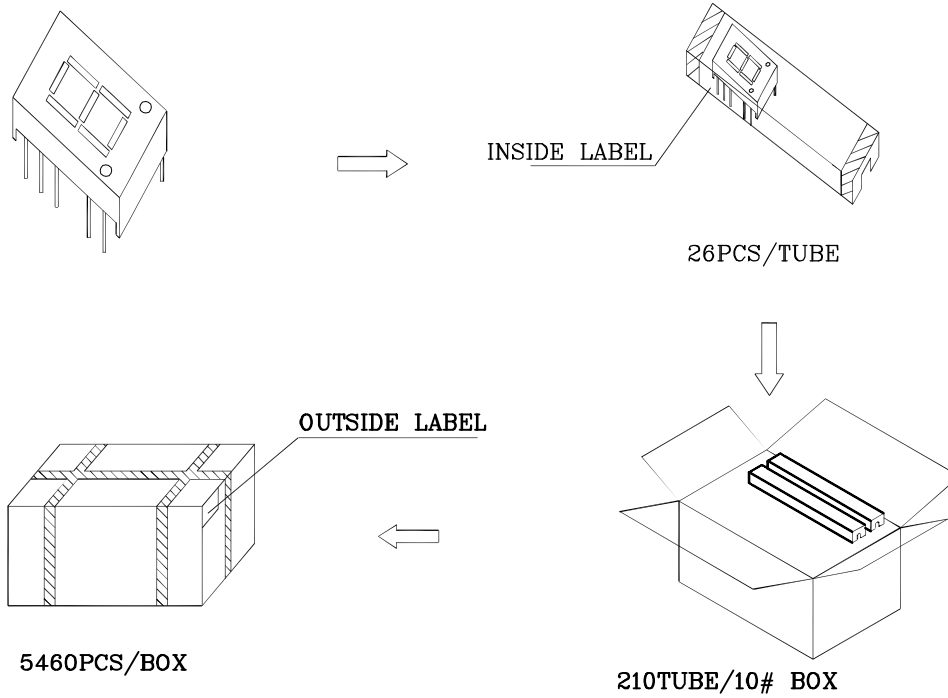

Inside Label On IC-tube

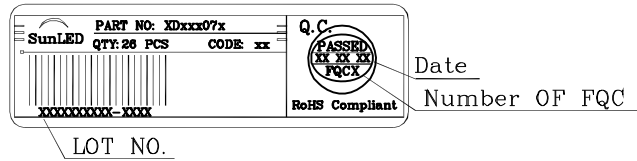

Outside Label On Box

