

Features

- 0.4 inch digit height
- Robust package
- Low power consumption
- Standard configuration: Gray face w/ white Segments
- Package: 250pcs/ reel
- Moisture sensitivity level: level 2a
- RoHS Compliant

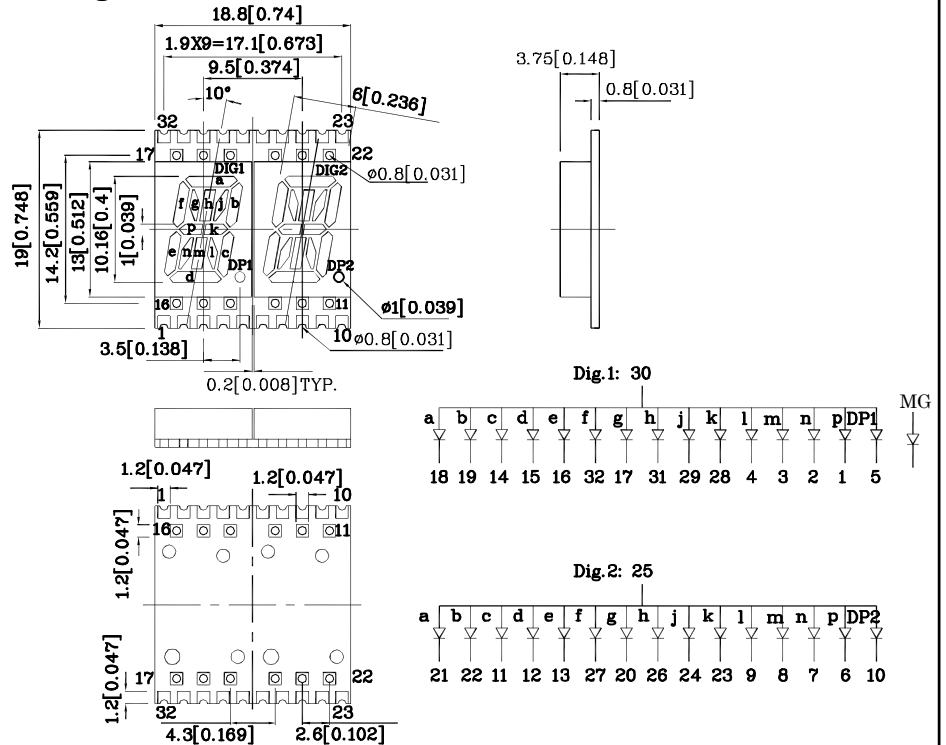

Package Schematics



Notes:

1. All dimensions are in millimeters (inches), Tolerance is $\pm 0.25(0.01)$ unless otherwise noted.
2. Specifications are subject to change without notice.
3. The gap between the reflector and PCB shall not exceed 0.25mm.

| Absolute Maximum Ratings ($T_A=25^\circ\text{C}$) | | MG (GaP) | Unit |
|--|-----------|-------------|------|
| Reverse Voltage | V_R | 5 | V |
| Forward Current | I_F | 25 | mA |
| Forward Current (Peak) 1/10 Duty Cycle 0.1ms Pulse Width | i_{FS} | 140 | mA |
| Power Dissipation | P_D | 62.5 | mW |
| Operating Temperature | T_A | -40 ~ +85 | °C |
| Storage Temperature | T_{stg} | -40 ~ +85 | |

| Operating Characteristics ($T_A=25^\circ\text{C}$) | | MG (GaP) | Unit |
|---|-----------------|-------------|---------------|
| Forward Voltage (Typ.) ($I_F=10\text{mA}$) | V_F | 2 | V |
| Forward Voltage (Max.) ($I_F=10\text{mA}$) | V_F | 2.5 | V |
| Reverse Current (Max.) ($V_R=5\text{V}$) | I_R | 10 | μA |
| Wavelength of Peak Emission (Typ.) ($I_F=10\text{mA}$) | λ_P | 565 | nm |
| Wavelength of Dominant Emission (Typ.) ($I_F=10\text{mA}$) | λ_D | 568 | nm |
| Spectral Line Full Width At Half-Maximum (Typ.) ($I_F=10\text{mA}$) | $\Delta\lambda$ | 30 | nm |
| Capacitance (Typ.) ($V_F=0\text{V}$, $f=1\text{MHz}$) | C | 15 | pF |

| Part Number | Emitting Color | Emitting Material | Luminous Intensity ($I_F=10\text{mA}$) ucd | | Wavelength nm λ_P | Description |
|-------------|----------------|-------------------|--|------|---------------------------------|-----------------------------------|
| | | | min. | typ. | | |
| XZFAMG10A2 | Green | GaP | 1400 | 2890 | 565 | Common Anode, Rt.Hand Decimal. |

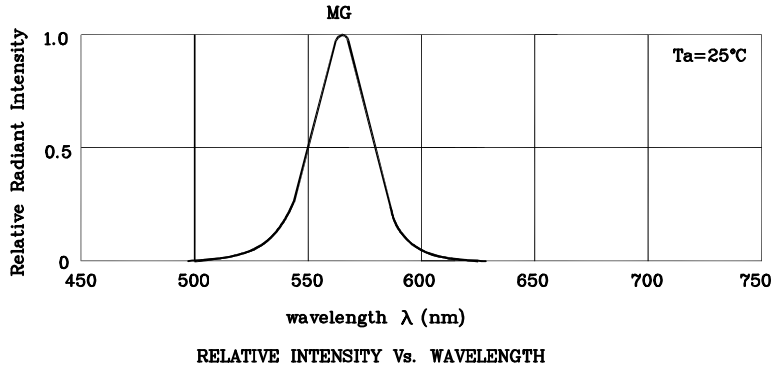

❖ MG

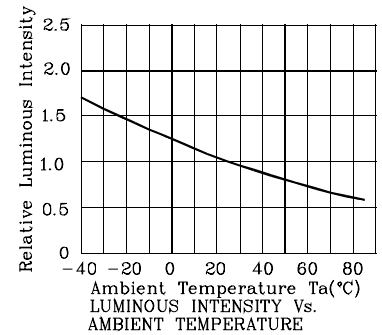
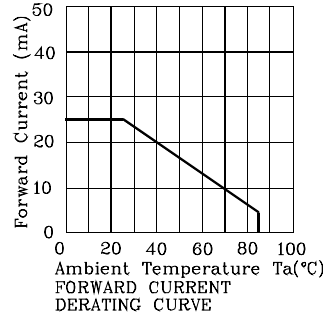
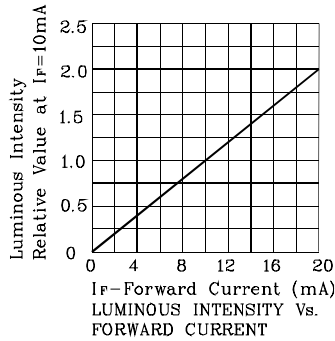
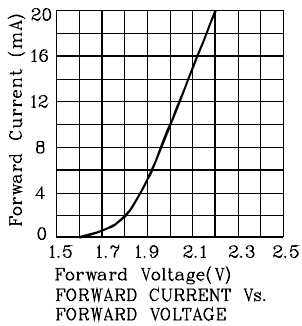

LED is recommended for reflow soldering and soldering profile is shown below.

Reflow Soldering Profile for SMD Products (Pb-Free Components)



1. Maximum soldering temperature should not exceed 260°C
2. Recommended reflow temperature: 145°C-260°C
3. Do not put stress to the epoxy resin during high temperatures conditions



PACKING & LABEL SPECIFICATIONS

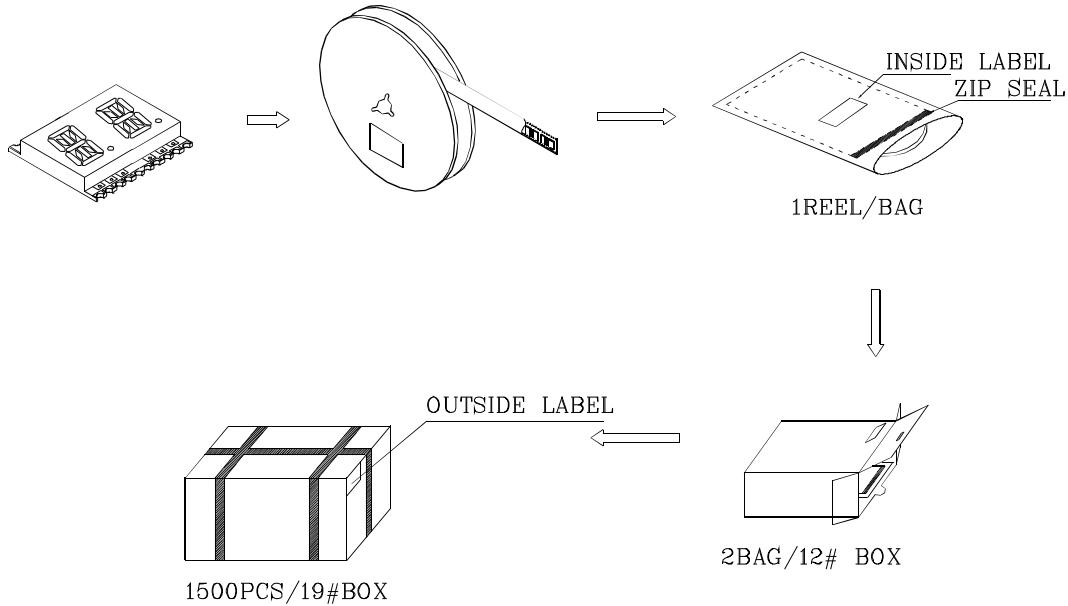

Inside LABEL On Tape

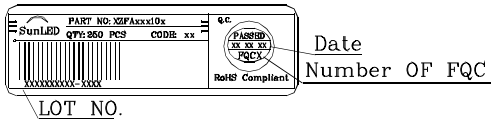

Outside LABEL On BAG

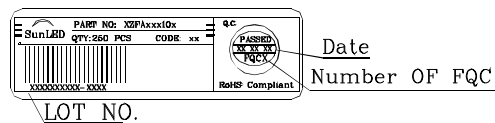

Outside LABEL On 19#Box

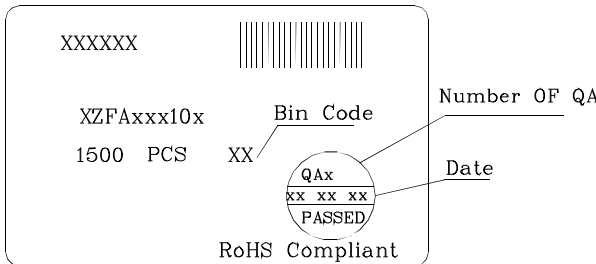

Outside LABEL On 12#Box

