

❖ UR

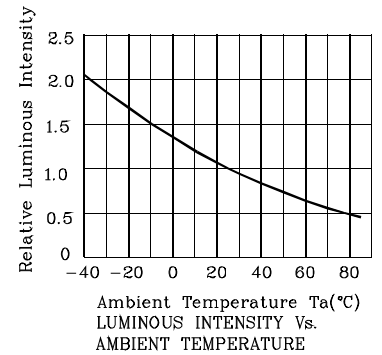

LED is recommended for reflow soldering and soldering profile is shown below.

Reflow Soldering Profile for SMD Products (Pb-Free Components)

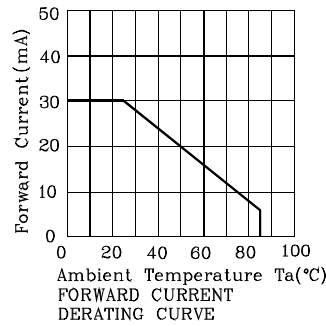
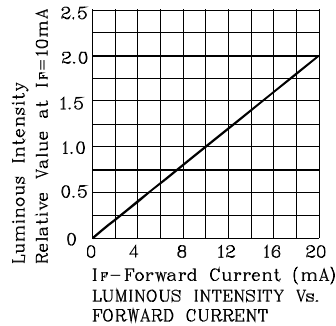
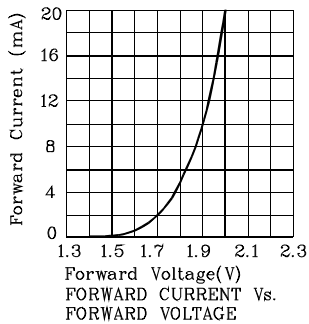

Notes:

1. Maximum soldering temperature should not exceed 260°C
2. Recommended reflow temperature: 145°C-260°C
3. Do not put stress to the epoxy resin during high temperatures conditions



PACKING & LABEL SPECIFICATIONS

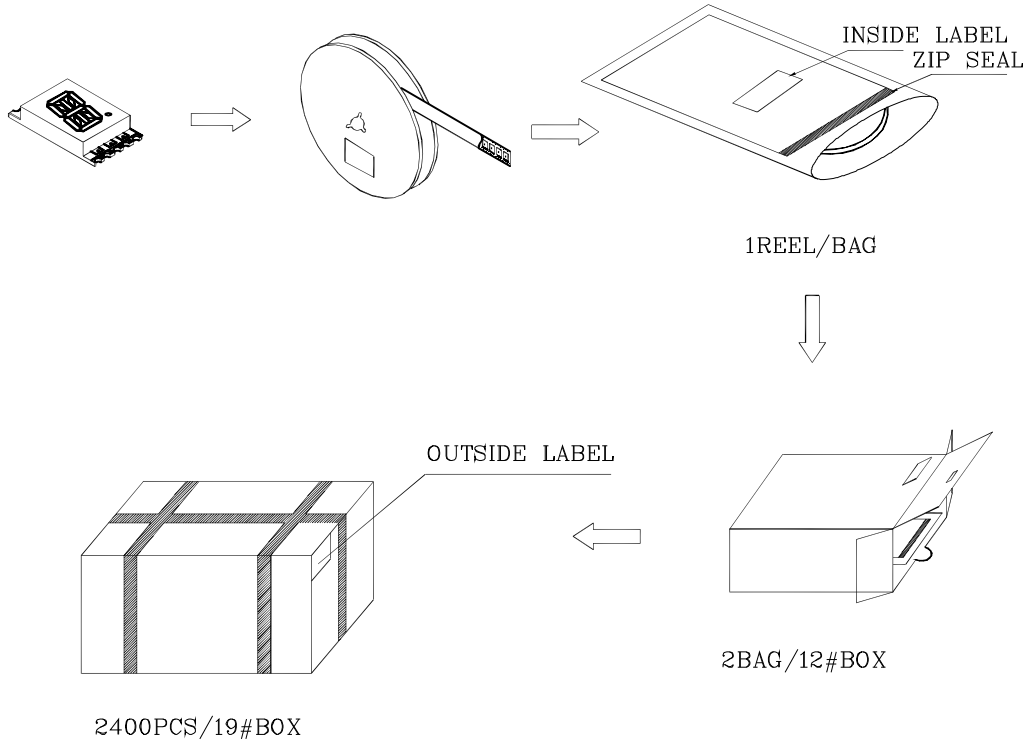

Inside Label On tape

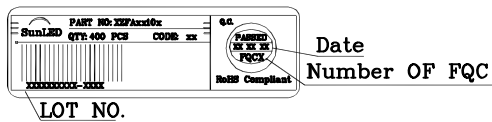

Outside Label On BAG

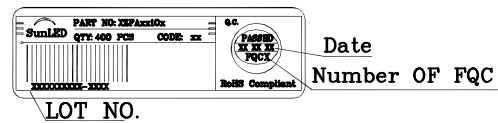

Outside Label On 19#Box

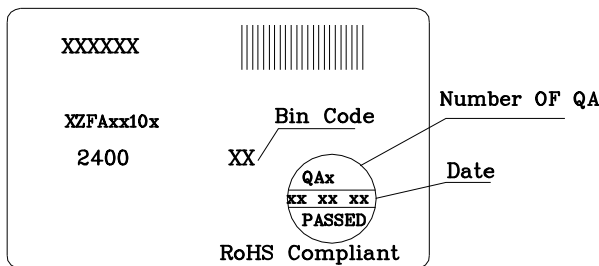

Outside Label On 12#Box

