

Features

- LED FIRMLY HELD BY SPACER-NO ADDITIONAL FIXTURING OR GLUEING NECESSARY.
- SUITABLE FOR BACK PANEL ILLUMINATION, CIRCUIT BOARD INDICATOR, LED INDICATOR.
- UL RATING:94V-0.
- HOUSING MATERIAL:TYPE 66 NYLON.
- RoHS COMPLIANT.

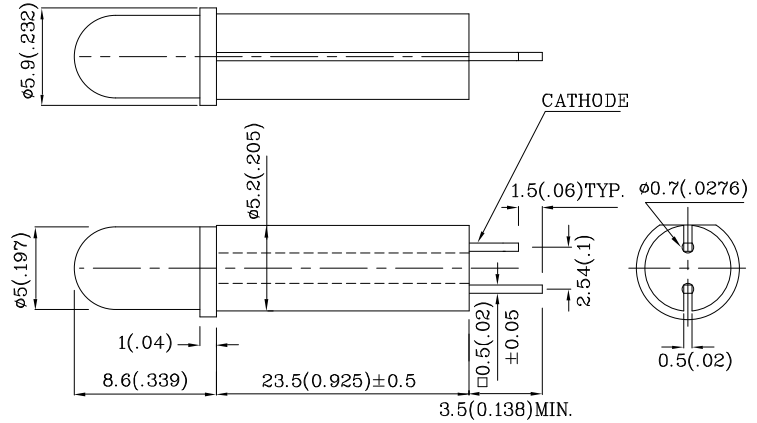

Notes:

1. All dimensions are in millimeters (inches).
2. Tolerance is ± 0.25(0.01") unless otherwise noted.
3. Specifications are subject to change without notice.

Absolute Maximum Ratings (TA=25°C)		UR (GaAsP/GaP)	Unit
Reverse Voltage	VR	5	V
Forward Current	IF	30	mA
Forward Current (Peak) 1/10Duty Cycle 0.1ms Pulse Width	iFS	160	mA
Power Dissipation	PT	75	mW
Operating Temperature	TA	-40 ~ +85	°C
Storage Temperature	Tstg	-40 ~ +85	
Lead Solder Temperature [2mm Below Package Base]	260°C For 3 Seconds		
Lead Solder Temperature [5mm Below Package Base]	260°C For 5 Seconds		

Operating Characteristics (TA=25°C)		UR (GaAsP/GaP)	Unit
Forward Voltage (Typ.) (IF=10mA)	VF	1.9	V
Forward Voltage (Max.) (IF=10mA)	VF	2.5	V
Reverse Current (Max.) (VR=5V)	IR	10	uA
Wavelength Of Peak Emission (Typ.) (IF=10mA)	λ P	627	nm
Wavelength Of Dominant Emission (Typ.) (IF=10mA)	λ D	625	nm
Spectral Line Full Width At Half-Maximum (Typ.) (IF=10mA)	Δλ	45	nm
Capacitance (Typ.) (VF=0V, f=1MHz)	C	15	pF

Part Number	Emitting Color	Emitting Material	Lens-color	Luminous Intensity (IF=10mA) mcd		Wavelength nm λ P	Viewing Angle 2 θ 1/2
				min.	typ.		
XNM1LUR12D23.5	Red	GaAsP/GaP	Red Diffused	8	44	627	30°
Published Date : JAN 23,2008 Drawing No : XDSA7900 V2 Checked : B.LLIU P.1/4							

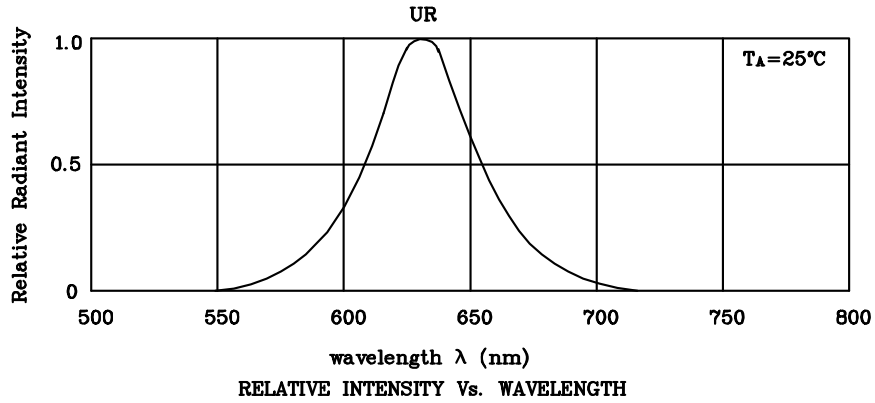

❖ UR

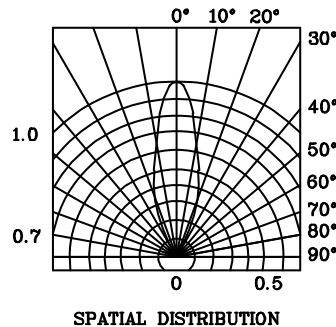
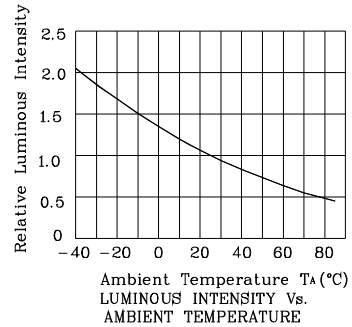
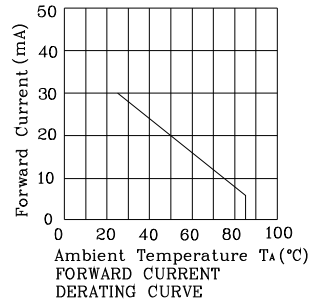
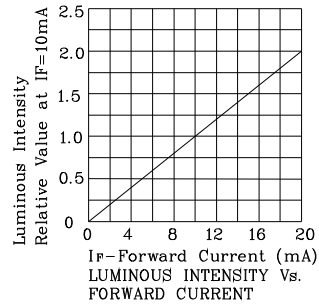
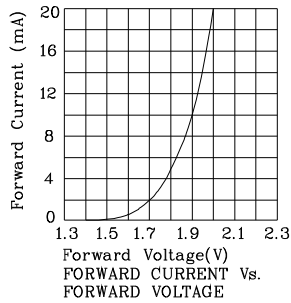

Wave Soldering Profile For Lead-free Through-hole LED.

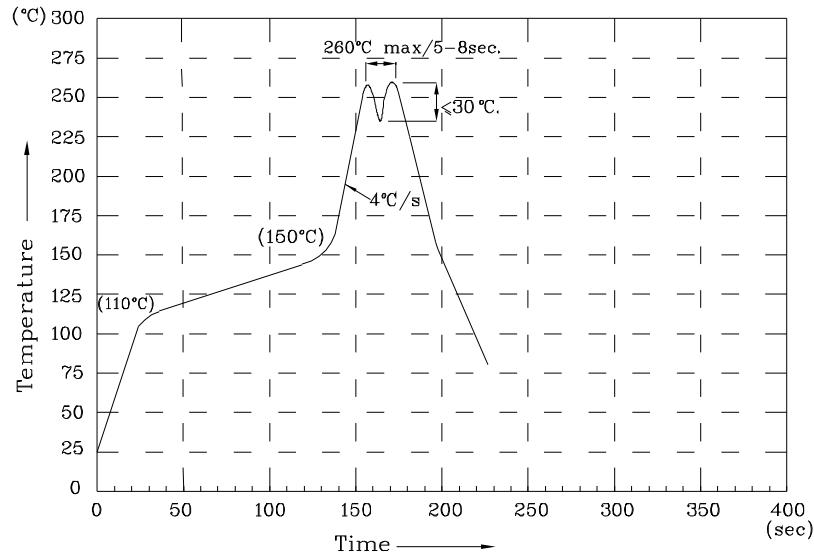

NOTES:

- 1.Recommend the wave temperature 245°C~260°C.The maximum soldering temperature should be less than 260°C.
- 2.Do not apply stress on epoxy resins when temperature is over 85 degree°C.
- 3.The soldering profile apply to the lead free soldering (Sn/Cu/Ag alloy).
- 4.No more than once.

Remarks:

If special sorting is required (e.g. binning based on forward voltage, Luminous intensity/ luminous flux, or wavelength), the typical accuracy of the sorting process is as follows:

1. Wavelength: +/-1nm
2. Luminous intensity/ luminous flux: +/-15%
3. Forward Voltage: +/-0.1V

Note: Accuracy may depend on the sorting parameters.

PACKING & LABEL SPECIFICATIONS

XNM1LUR12D23.5

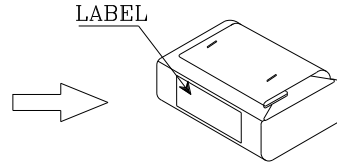
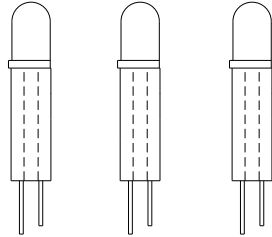

200 PCS/Bag

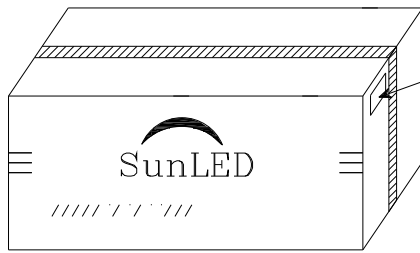

12.8K/BOX

OUTSIDE LABEL

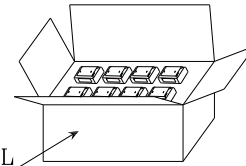

OUTSIDE LABEL

1.6K/BOX

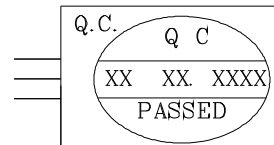

P/NO : XNM1Lxx12x	
QTY : 200 pcs	CODE: XXX
S/N : XX	
LOT NO:	
 XXXXXXXXXXXXXXXXXXXXX	
RoHS Compliant	