

Features

- Housing material: Type 66 Nylon
- Black casing provides superior contrast
- Housing UL rating: 94V-0
- Reliable & robust
- Custom color combinations available
- 5V internal resistor
- RoHS Compliant

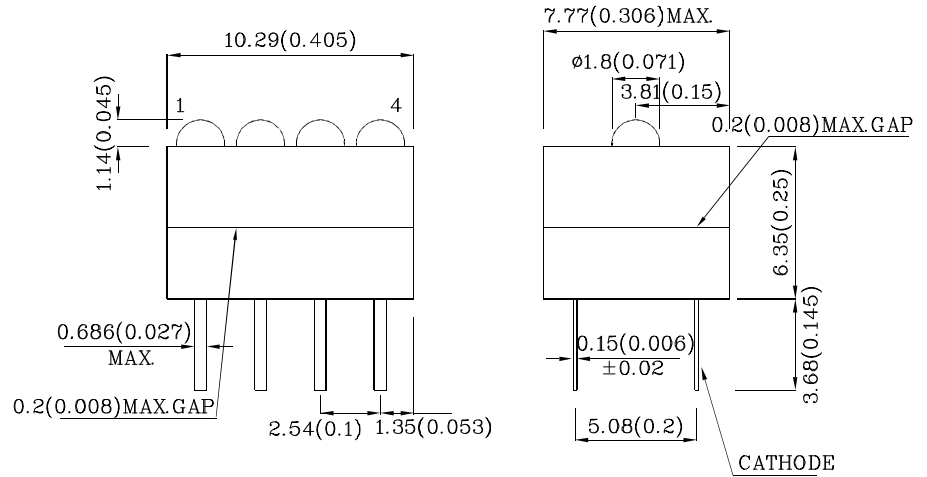

Package Schematics



- Notes:
 1. All dimensions are in millimeters (inches).
 2. Tolerance is ±0.25(0.01") unless otherwise noted.
 3. Specifications are subject to change without notice.

Absolute Maximum Ratings (T _A =25°C)		MG (GaP)	Unit
Reverse Voltage	V _R	5	V
Forward Voltage	V _F	6	V
Power Dissipation	P _D	85	mW
Operating Temperature	T _A	-40 ~ +70	°C
Storage Temperature	T _{stg}	-40 ~ +85	
Lead Solder Temperature [2mm Below Package Base]	260°C For 3 Seconds		
Lead Solder Temperature [5mm Below Package Base]	260°C For 5 Seconds		

Operating Characteristics (T _A =25°C)		MG (GaP)	Unit
Forward Current (Typ.) (V _F =5V)	I _F	11.5	mA
Forward Current (Max.) (V _F =5V)	I _F	17.5	mA
Reverse Current (Max.) (V _R =5V)	I _R	10	uA
Wavelength of Peak Emission (Typ.) (V _F =5V)	λ _P	565	nm
Wavelength of Dominant Emission (Typ.) (V _F =5V)	λ _D	568	nm
Spectral Line Full Width At Half-Maximum (Typ.) (V _F =5V)	Δλ	30	nm

Part Number	Emitting Color	Emitting Material	Lens-color	Luminous Intensity (V _F =5V) mcd		Wavelength nm λ _P	Viewing Angle 2θ 1/2
				min.	typ.		
XNG4ZMG46D5V	Green	GaP	Green Diffused	4	9	565	40°

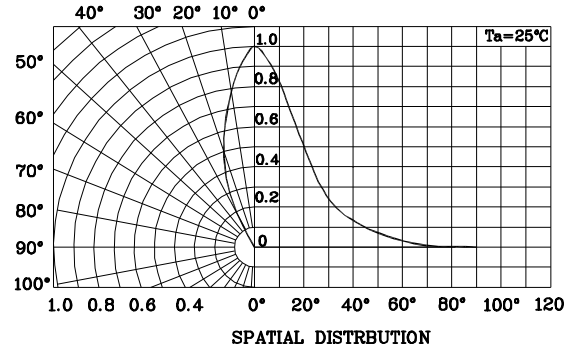
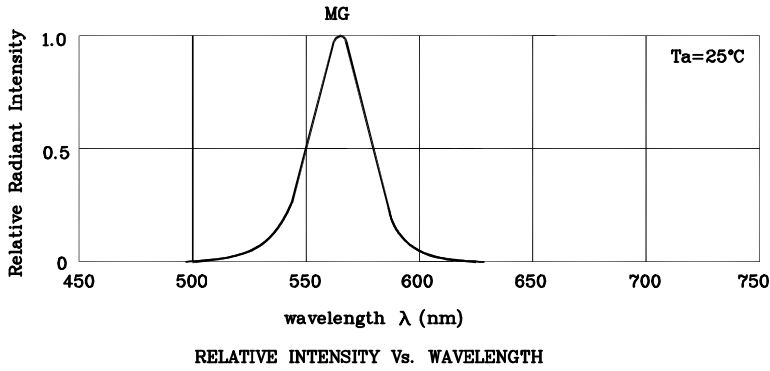

❖ MG

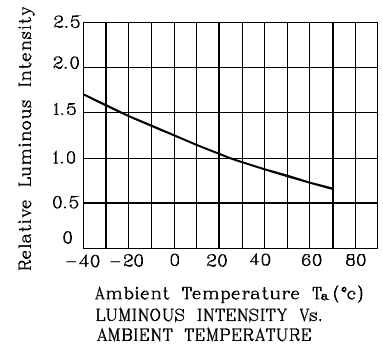
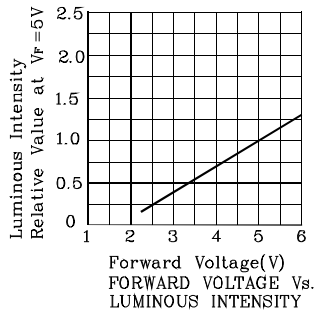
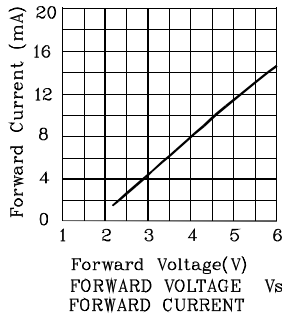

Wave Soldering Profile for Thru-Hole Products (Pb-Free Components)

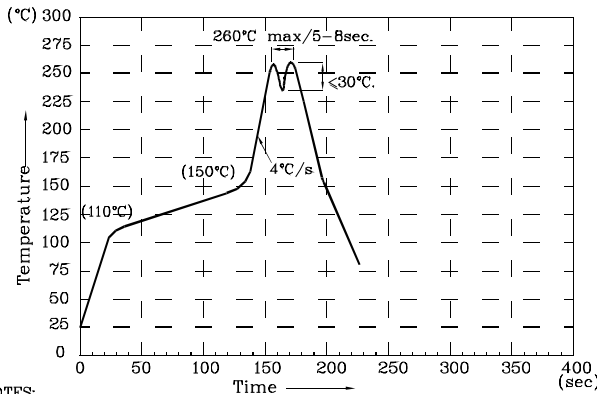

NOTES:

1. Recommend the wave temperature 245°C~260°C. The maximum soldering temperature should be less than 260°C.
2. Do not apply stress on epoxy resins when temperature is over 85°C.
3. The soldering profile apply to the lead free soldering (Sn/Cu/Ag alloy).
4. During wave soldering, the PCB top-surface temperature should be kept below 105°C.
5. No more than once.

Remarks:

If special sorting is required (e.g. binning based on Luminous intensity/ luminous flux, or wavelength), the typical accuracy of the sorting process is as follows:

1. Wavelength: +/-1nm
2. Luminous intensity/ luminous flux: +/-15%

Note: Accuracy may depend on the sorting parameters.

PACKING & LABEL SPECIFICATIONS

