

RG 125-19/14 N

DC centrifugal compact fan

single inlet



ebm-papst St. Georgen GmbH & Co. KG

Hermann-Papst-Str. 1
D-78112 St. Georgen
Phone +49 (0) 7724 81-0
Fax +49 (0) 7724 81-1309
info2@de.ebmpapst.com
www.ebmpapst.com

Nominal data

Type	RG 125-19/14 N	
Nominal voltage	VDC	24
Nominal voltage range	VDC	12 .. 28
Speed	min ⁻¹	2550
Power input	W	4.9
Min. ambient temperature	°C	-30
Max. ambient temperature	°C	75
Air flow	m ³ /h	87.5
Sound power level	B	5.8

mi = Max. load · me = Max. efficiency · fa = Running at free air · cs = Customer specs · cu = Customer unit
Subject to alterations



Technical features

Mass	0.730 kg
Dimensions	180 x 180 x 40 mm
Material of impeller	Fiberglass-reinforced plastic
Housing material	Scroll housing of fiberglass-reinforced plastic, housing base of sheet steel.
Direction of air flow	Axial air intake, centrifugal air exhaust out of the outlet.
Bearing	Ball bearings
Lifetime L10 at 40 °C	62500 h
Lifetime L10 at maximum temperature	27500 h
Connection line	Single strands AWG 22, TR 64, bared and tin-plated.
Motor protection	Protected against reverse polarity and locking.
Locked-rotor protection	Blocking and overload protection
Approval	VDE, CSA, UL, CE

Product drawing

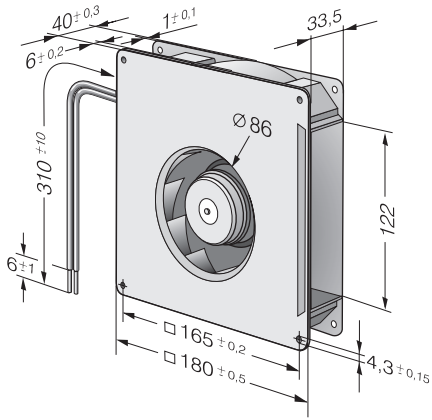

Charts: Air flow

