

8212 JN

# DC axial compact fan



## ebm-papst St. Georgen GmbH & Co. KG

Hermann-Papst-Straße 1

D-78112 St. Georgen

Phone +49 7724 81-0

Fax +49 7724 81-1309

info2@de.ebmpapst.com

www.ebmpapst.com

## Nominal data

Type	8212 JN	
Nominal voltage	VDC	12
Nominal voltage range	VDC	7 .. 13.8
Speed	min <sup>-1</sup>	8400
Power input	W	10
Min. ambient temperature	°C	-20
Max. ambient temperature	°C	70
Air flow	m <sup>3</sup> /h	132
Sound power level	B	6.6
Sound pressure level	dB(A)	55

ml = max. load · me = max. efficiency · rfa = running at free air · cs = customer specs · cu = customer unit  
Subject to alterations



## Technical features

<b>Dimensions</b>	80 x 80 x 38 mm
<b>General description</b>	<p>Particular design features:</p> <p>Rigid compression curve for high air flow at high counterpressure.</p> <p>Innovative impeller with winglets for low noise.</p> <p>Optional Vario-Pro: Highly flexible software configuration for the fan ensures an easily customisable solution to meet the individual requirements of your application.</p> <p>General features:</p> <p>Material: fibreglass-reinforced plastic. Impeller PA, housing PBT.</p> <p>Electronic commutation completely integrated.</p> <p>Protected against reverse polarity and locking.</p> <p>Connection via single strands AWG 24 (H3 and H4: AWG 22), TR 64, bared and tin-plated.</p> <p>Air exhaust over bars. Direction of rotation counter-clockwise seen on rotor.</p> <p>Mass: 160 g (H3 and H4: 200 g).</p>
<b>Connection line</b>	Single strands AWG 24, TR 64, bared and tin-plated.
<b>Locked-rotor protection</b>	With electronic blocking and overload protection
<b>Direction of rotation</b>	Left, looking at rotor
<b>Direction of air flow</b>	Air exhaust over bars
<b>Bearing</b>	Ball bearings
<b>Lifetime L10 at 40 °C</b>	62500 h
<b>Lifetime L10 at maximum temperature</b>	32500 h
<b>Mass</b>	0.160 kg
<b>Housing material</b>	Fiberglass-reinforced PBT plastic
<b>Material of impeller</b>	Fiberglass-reinforced PA plastic
<b>Motor protection</b>	Protected against reverse polarity and locking.
<b>Approval</b>	CE

## Product drawing

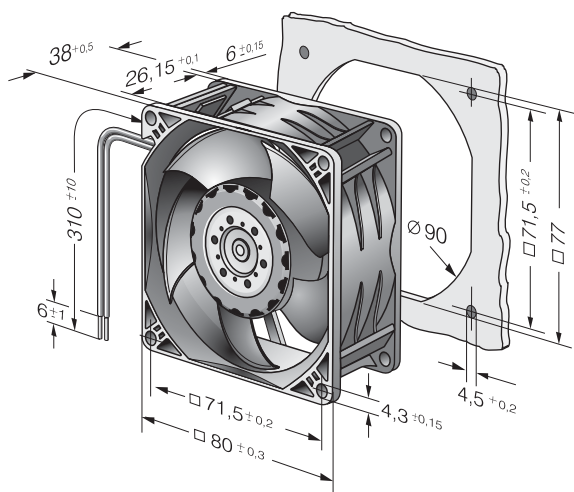

## Charts: Air flow

