

6224 NH

DC axial compact fan



ebm-papst St. Georgen GmbH & Co. KG

Hermann-Papst-Straße 1

D-78112 St. Georgen

Phone: +49(0)7724/81-0

Fax: +49(0)7724/81-1309

info2@de.ebmpapst.com

www.ebmpapst.com

Nominal data

Type	6224 NH	
Nominal voltage	VDC	24
Nominal voltage range	VDC	12 .. 28
Speed	min ⁻¹	4000
Power input	W	26.0
Min. ambient temperature	°C	-20
Max. ambient temperature	°C	55
Air flow	m ³ /h	480
Sound power level	B	6.9
Sound pressure level	dB(A)	61

ml = max. load · me = max. efficiency · rfa = running at free air · cs = customer specs · cu = customer unit
Subject to alterations

Technical features

Dimensions	172 Ø x 51 mm
General description	VARIOFAN models available with external temperature sensor. Optional Vario-Pro: Highly flexible software configuration for the fan ensures an easily customizable solution to meet the individual requirements of your application. Commutation electronics completely integrated.
Connection line	Flat plugs 3.0 x 0.5 mm. Optional version with strands.
Locked-rotor protection	Electronic blocking protection, with electronic motor current limit in the startup phase and when the rotor is blocked.
Direction of rotation	Left, looking at rotor
Direction of air flow	Air exhaust over bars
Bearing	Ball bearings
Lifetime L10 at 40 °C	70000 h
Lifetime L10 at maximum temperature	50000 h
Mass	0.820 kg
Housing material	Aluminum. Housing with grounding lug for screw M4 x 8 (TORX).
Material of impeller	Fiberglass-reinforced PA plastic
Motor protection	Protected against reverse polarity and locking.
Approval	VDE, CSA, UL, CE

Product drawing

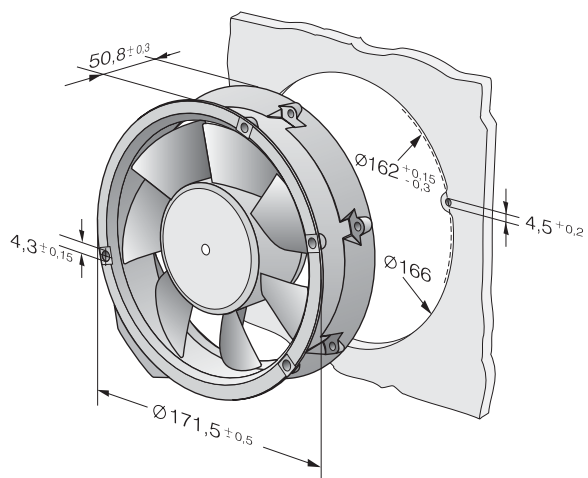

Charts: Air flow

