

**ebm-papst St. Georgen GmbH & Co. KG**

Hermann-Papst-Str. 1
 D-78112 St. Georgen
 Phone +49 (0) 7724 81-0
 Fax +49 (0) 7724 81-1309
 info2@de.ebmpapst.com
 www.ebmpapst.com

Nominal data

Type	3312	
Nominal voltage	VDC	12
Nominal voltage range	VDC	6 .. 15
Speed	min ⁻¹	3000
Power input	W	2.5
Min. ambient temperature	°C	-20
Max. ambient temperature	°C	75
Air flow	m ³ /h	80
Sound power level	B	5.2
Sound pressure level	dB(A)	37

ml = Max. load · me = Max. efficiency · fa = Running at free air · cs = Customer specs · cu = Customer unit
 Subject to alterations



Technical features

Mass	0.190 kg
Dimensions	92 x 92 x 32 mm
Material of impeller	Fiberglass-reinforced PA plastic
Housing material	Fiberglass-reinforced PBT plastic
Direction of air flow	Air exhaust over bars
Direction of rotation	Right, looking at rotor
Bearing	Ball bearings
Lifetime L10 at 40 °C	70000 h
Lifetime L10 at maximum temperature	30000 h
Connection line	Single strands AWG 22, TR 64, bared and tin-plated.
Motor protection	Protected against reverse polarity and locking.
Approval	VDE, CSA, UL



Product drawing

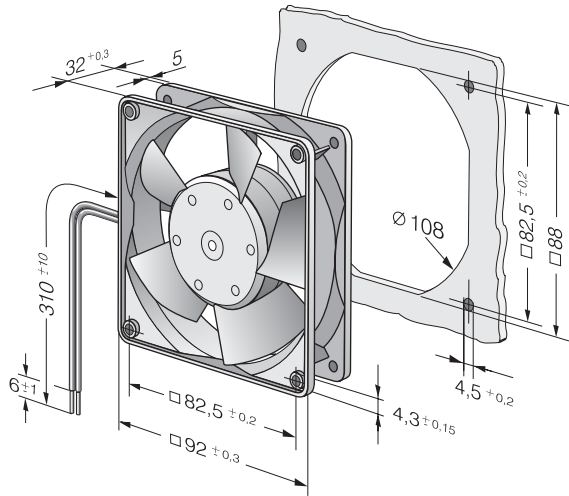

Charts: Air flow

