

**ebm-papst St. Georgen GmbH & Co. KG**

Hermann-Papst-Straße 1

D-78112 St. Georgen

Phone +49 7724 81-0

Fax +49 7724 81-1309

info2@de.ebmpapst.com

www.ebmpapst.com

Nominal data

Type	3506	
Phase		1~
Nominal voltage	VAC	115
Frequency	Hz	60
Speed	min ⁻¹	2600
Power input	W	8.0
Min. ambient temperature	°C	-40
Max. ambient temperature	°C	95
Air flow	m ³ /h	73
Sound power level	B	4.7
Sound pressure level	dB(A)	36

ml = max. load · me = max. efficiency · fa = running at free air · cs = customer specs · cu = customer unit
Subject to alterations



Technical features

General description	<p>AC voltage fan with external rotor shaded-pole motor. Protected from overload by impedance protection. Fan housing and fan impeller made of metal. Air exhaust over bars. Rotational direction clockwise looking at rotor. Electrical connection to 2 single strands. Strand ends bared and tin-plated. Fan housing with grounding lug and tapping screw M4 x 8 (TORX). Mass 420 g. Please note our new ACmaxx series. With identical fastening dimensions and voltages, this series achieves higher energy efficiency.</p>
Mass	0.420 kg
Dimensions	92 x 92 x 38 mm
Material of impeller	Metal
Housing material	Metal
Direction of air flow	Air exhaust over bars
Direction of rotation	Right, looking at rotor
Bearing	Ball bearings
Lifetime L10 at 40 °C	62500 h
Lifetime L10 at maximum temperature	17500 h
Connection line	2 single strands AWG 18
Motor protection	Protected from overload using impedance protection
Approval	VDE, CSA, UL, CE

Product drawing

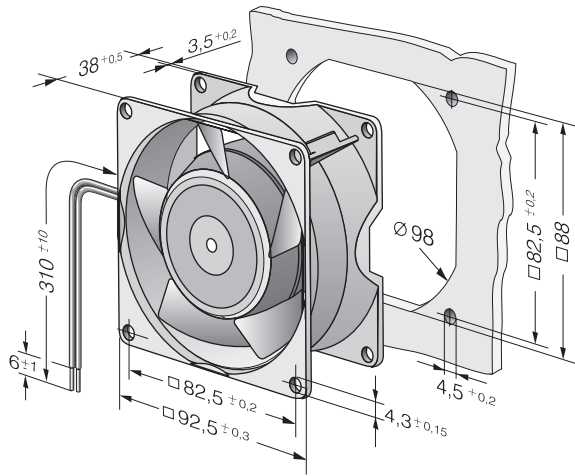

Charts: Air flow

