

TPC-2140WP

21.5" Full HD TFT LCD Touch
Panel Computer with AMD
Dual-core processor



product
design award

2013

NEW

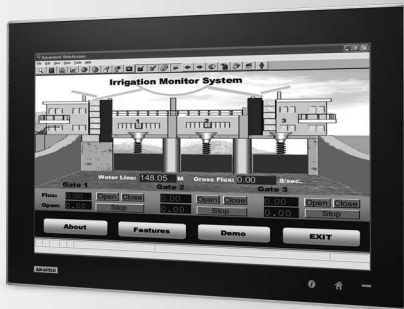

Features

- 21.5" Full HD TFT LED LCD display
- AMD dual-core T56E 1.65GHz with independent GPU, advanced graphical performance
- 16:9 wide screen with PCT multi-touch
- Built-in function and home key button used for intuitive UI
- Anti-scratch surface: 7H hardness
- Easy Maintenance of Cfast/HDD/Mini-PCIe components by opening side cover
- Support Mini-PCIe expansion slot
- Support HDMI for second display application
- HD Audio supports for alarm application
- Front LED indicator to show operating status
- IP65 compliant true flat screen
- Compact design with Die-cast Magnesium alloy front bezel
- Fanless cooling system
- Winner of the 2013 iF product design award

Introduction

With a brand-new ID design, the TPC-2140WP provides a high resolution 21.5" display and PCT multi-touch in 16:9 wide format. By embedding an AMD T56E 1.65GHz processor with independent GPU, the TPC-2140WP can support advanced graphical performance in more complex applications. Built-in function and home key button for greater user usability and operating safety. The TPC-2140WP also supports a mini-PCIe slot for communication function expansion. The opening side cover is designed for easy maintenance of Cfast/HDD/Mini-PCIe components.

Specifications

General

- **BIOS** AMI 32Mbit
- **Certification** BSMI, CCC, CE, FCC Class A, UL
- **Cooling System** Fanless design
- **Dimensions (W x H x D)** 558.4 x 349.8 x 56.7 (22" x 13.8" x 2.2")
- **Enclosure** Front bezel: Die-cast Magnesium alloy
Back housing: PC/ABS Resin
- **Mounting** Panel Mount
- **OS Support** Microsoft® Win8/WES7P/XP/WES2009/Linux
- **Power Consumption** 35 W Typical
- **Power Input** 18 ~ 32 V_{DC}
- **Watchdog Timer** 1 ~ 255 sec (system)
- **Weight (Net)** 8.5 kg (18.74 lbs)

System Hardware

- **CPU** AMD G-series T56E 1.65GHz
- **Chipset** AMD A50M FCH
- **Memory** 4GB SO-DIMM DDR3 SDRAM
- **LAN** 10/100/1000Base-T x 2
- **Expansion Slots** Full-sized Mini PCI-E x 1
- **Storage** CFast slot x 1
2.5" SATA HDD x 1(optional)
- **I/O** RS-232 x 3
RS-422 / 485 x 1
USB 2.0 x 2(Host)
HDMI x 1
Mic in x 1, Line out x 1

LCD Display

- **Display Type** Full HD TFT LED LCD
- **Display Size** 21.5"
- **Max. Resolution** 1920 x 1080
- **Max. Colors** 16.7 M
- **Luminance cd/m²** 300
- **Viewing Angle (H/V°)** 178/178
- **Backlight Life** 50,000 hrs

Touchscreen

- **Light Transmission** ≥88%
- **Resolution** 4096*4096 dot
- **Type** Projected capacitive

Environment

- **Humidity** 10 ~ 95% RH @ 40°C, non-condensing
Note: Tested for 48hrs
- **Ingress Protection** Front panel: IP65
- **Operating Temperature** 0 ~ 55°C (32 ~ 131°F)
- **Storage Temperature** -20 ~ 60°C (-4 ~ 140°F)
- **Vibration Protection** With HDD: 1 Grms (5 ~ 500 Hz)
(Operating, random vibration)

Dimensions

Unit: mm [inch]

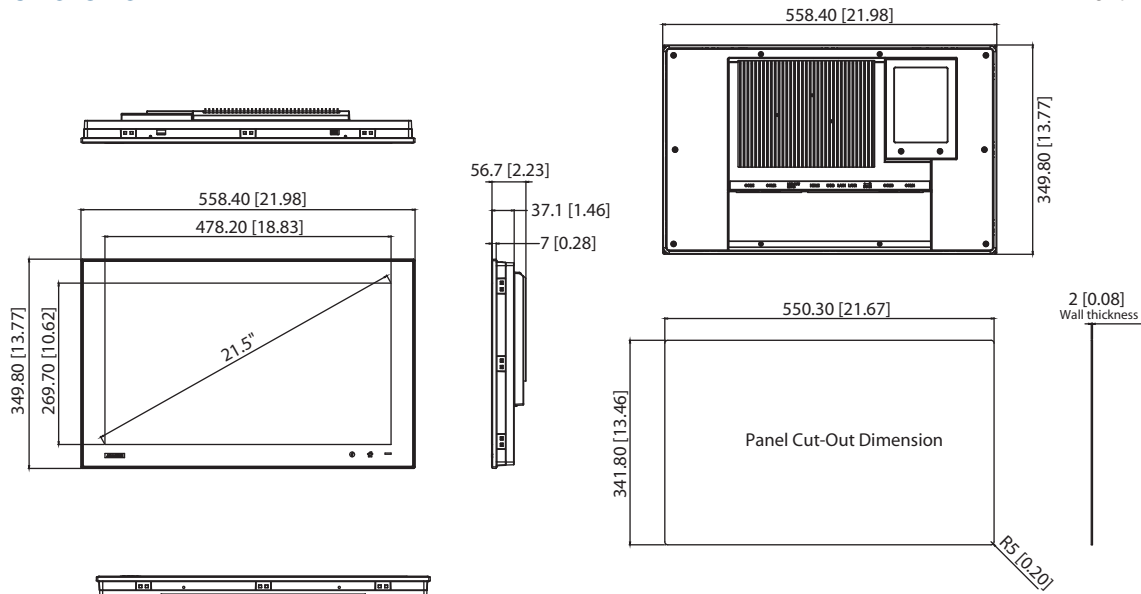

Panel Cut-out Dimensions: 550.3mm (21.7")±1mm x 341.8 (13.5")mm±0.7mm

Ordering Information

- **TPC-2140WP-T3AE** 21.5" full-HD Multi-Touch Panel PC, AMD T56E, 4GB

Accessory

- **1757003463** 100-240V_{AC} to 19V_{DC} 90W Power Adapter
- **1700001524** Power Cord 3P UL 10A 125V 1.8M
- **PWR-247-AE** 50W DC 24V/2.3A Output Power Supply
- **1702002605** Power cable EU Plug 1.8M
- **1702031801** Power cable UK Plug 1.8M
- **1702031836** Power cable China/Australia Plug 1.8M

Rear View

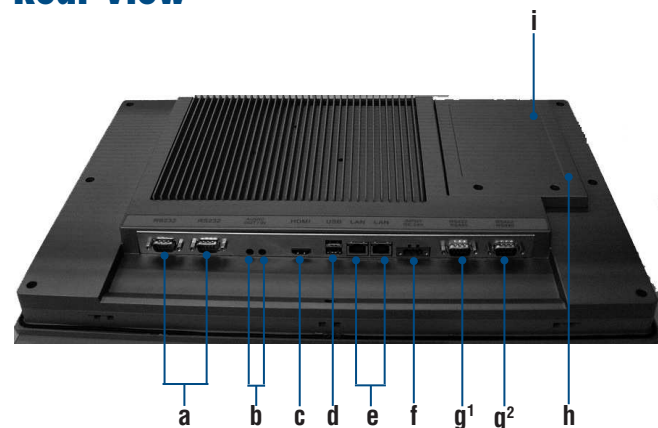

- a. COM 1 & 2 (RS-232)
- b. Audio (Line out, Mic in)
- c. HDMI
- d. USB 2.0
- e. LAN (10/100/1000)
- f. Power Receptor
- g¹. COM3 (RS-232)
- g². COM4 (RS-422/485)
- h. Mini PCI-E slot
- i. 2.5" SATA HDD Housing