

PART
NAME

DIN RAIL MOUNT BOX

PART
No.

DB-4701

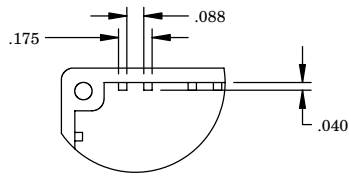

DETAIL B

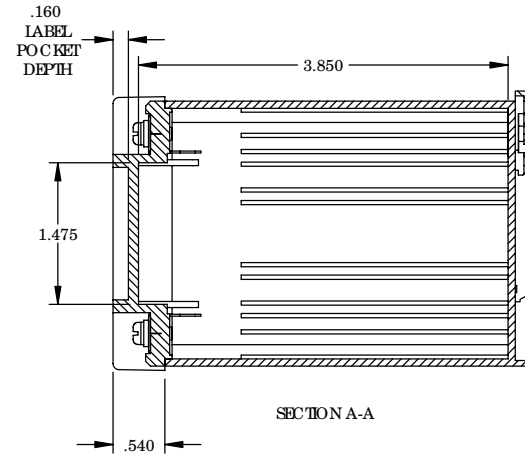
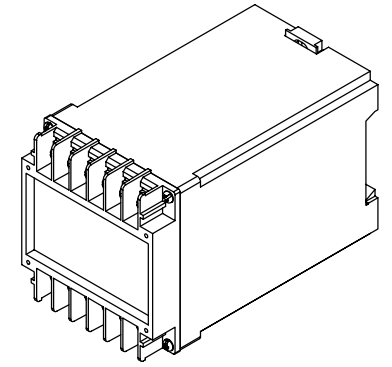
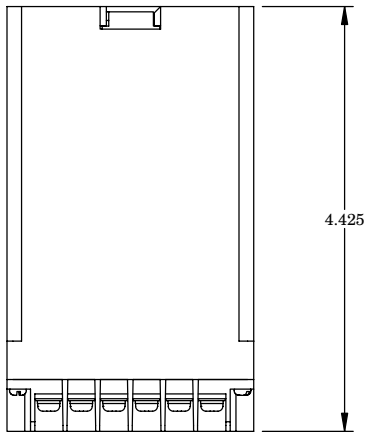

SECTION A-A

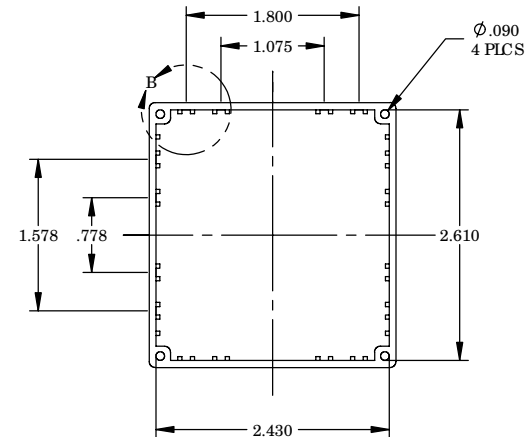
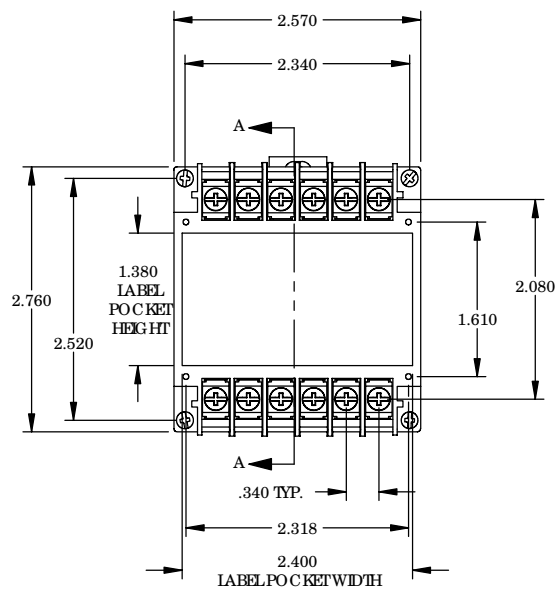

MATERIAL: UL94V-0 ABS PLASTIC

FINISH: LIGHT GRAY

FOUR (4) M3 SCREWS SUPPLIED TO
ATTACH FRONT PANEL

ALL DIMENSIONS HAVE A ± 0.15 TOLERANCE
UNLESS OTHERWISE SPECIFIED

ALL CONTACTS ARE TIN PLATED BRASS
RATED AT 10 AMPS