

PART NAME ECNDNDBOXES

PART No. CU-4470 TD CU-4479 & CU-470-G TD CU-479-G
CU-4470 TD CU-4479 & CU-4470-B TD CU-4479-B

REV. DATE 10-14-09

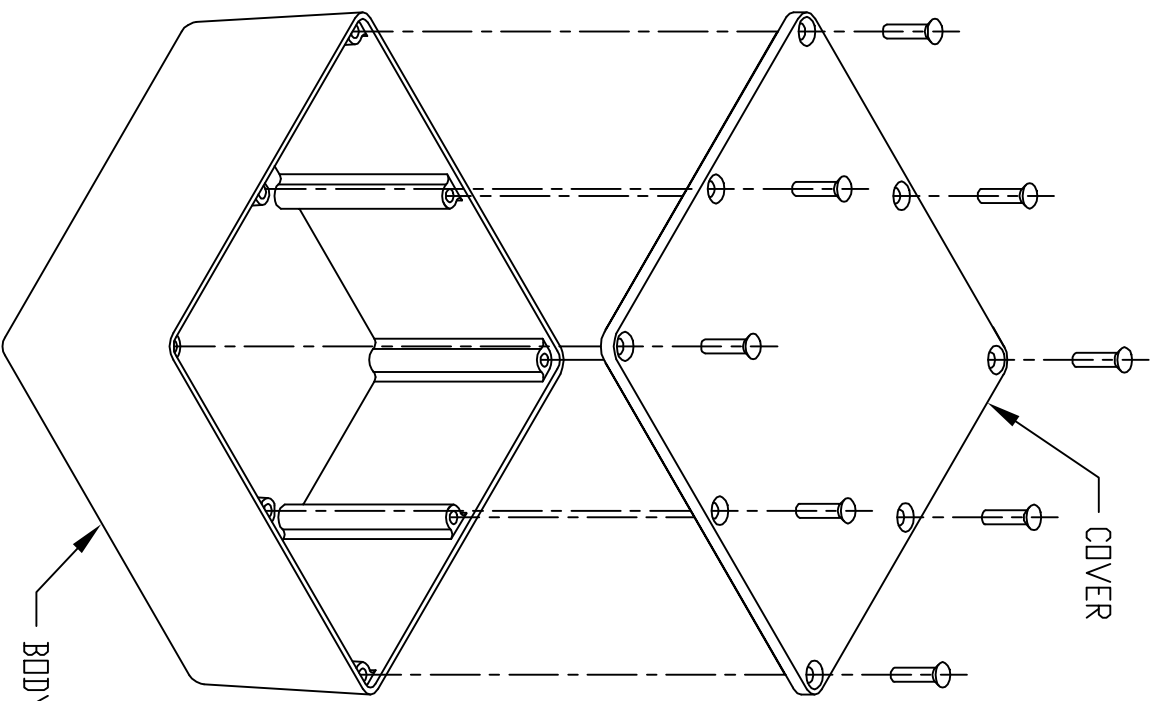
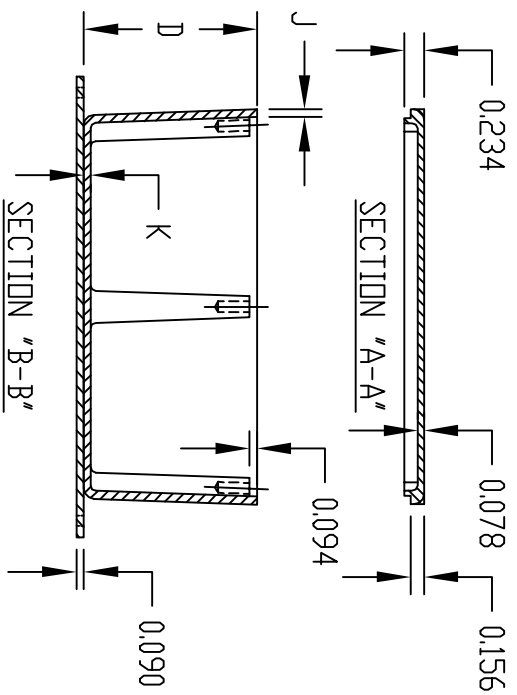
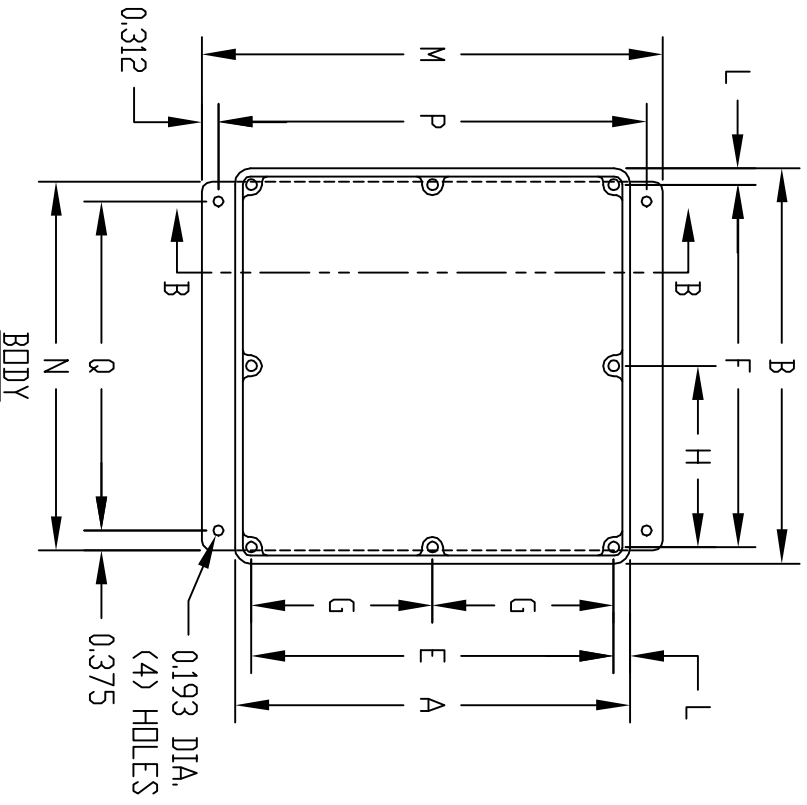
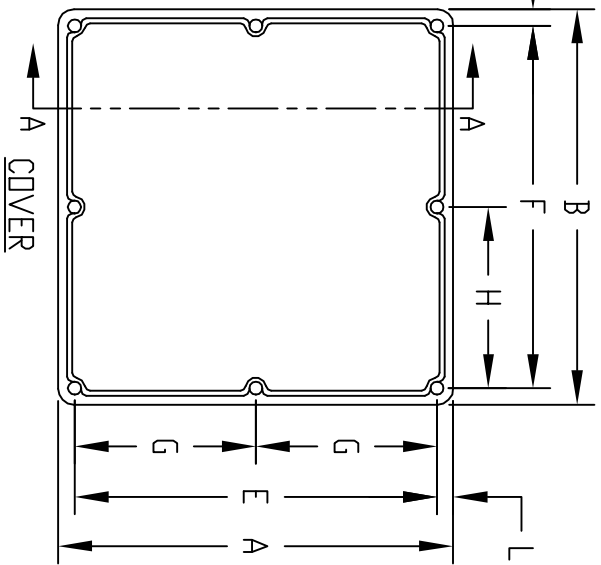

MATERIAL:
ALUMINUM ALLOY #ADC-12
FINISH:
NATURAL (ND SUFFIX)
GRAY (SUFFIX -G)
SMOOTH BLACK (SUFFIX -B)

ALL INTERNAL FILLETS 0.062 RADIUS
ALL INTERNAL ROUNDS 0.125 RADIUS
ALL EXTERNAL ROUNDS 0.125 RADIUS
ALL BOXES ASSEMBLED WITH #6-32 FLAT HD. SCREWS

PART NO. CU-4470 THRU CU-4479
AND CU-4470-B THRU CU-4479-B
ARE SUPPLIED WITH A WELDED ON
MOUNTING BRACKET ONLY.

* ASSEMBLED HEIGHT

PART NO.	PART NO.	A	B	* C	D	E	F	G	H	J	K	L	M	N	P	Q
CU-470	CU-470-G	2.000	2.000	1.250	1.094	1.625	1.625	----	----	0.065	0.065	0.188	----	----	----	----
CU-471	CU-471-G	4.330	3.250	1.750	1.594	3.955	2.875	----	----	0.094	0.078	0.188	----	----	----	----
CU-472	CU-472-G	4.750	3.150	2.330	2.174	4.375	2.775	----	----	0.094	0.078	0.188	----	----	----	----
CU-473	CU-473-G	4.688	3.688	1.340	1.184	4.313	3.313	----	----	0.094	0.078	0.188	----	----	----	----
CU-474	CU-474-G	4.750	4.750	2.330	2.174	4.375	4.375	----	----	0.094	0.078	0.188	----	----	----	----
CU-475	CU-475-G	4.750	4.750	3.750	3.594	4.375	4.375	----	----	0.094	0.078	0.188	----	----	----	----
CU-476	CU-476-G	6.000	3.250	2.000	1.844	5.610	2.860	2.805	----	0.094	0.078	0.195	----	----	----	----
CU-477	CU-477-G	7.390	4.703	1.500	1.344	7.000	4.313	3.500	----	0.094	0.078	0.195	----	----	----	----
CU-478	CU-478-G	7.500	7.500	2.620	2.464	7.110	7.110	3.555	3.555	0.094	0.078	0.195	----	----	----	----
CU-479	CU-479-G	4.375	2.375	2.136	1.980	4.000	2.000	----	----	0.065	0.078	0.188	----	----	----	----
CU-4470	CU-4470-B	2.000	2.000	1.250	1.094	1.625	1.625	----	----	0.065	0.065	0.188	3.250	1.625	2.626	0.875
CU-4471	CU-4471-B	4.330	3.250	1.750	1.594	3.955	2.875	----	----	0.094	0.078	0.188	5.624	2.875	5.000	2.125
CU-4472	CU-4472-B	4.750	3.150	2.330	2.174	4.375	2.775	----	----	0.094	0.078	0.188	6.000	2.750	5.376	2.000
CU-4473	CU-4473-B	4.688	3.688	1.340	1.184	4.313	3.313	----	----	0.094	0.078	0.188	6.000	2.750	5.376	2.000
CU-4474	CU-4474-B	4.750	4.750	2.330	2.174	4.375	4.375	----	----	0.094	0.078	0.188	6.000	2.750	5.376	2.000
CU-4475	CU-4475-B	4.750	4.750	3.750	3.594	4.375	4.375	----	----	0.094	0.078	0.188	6.000	2.750	5.376	2.000
CU-4476	CU-4476-B	6.000	3.250	2.000	1.844	5.610	2.860	2.805	----	0.094	0.078	0.188	5.874	4.250	5.250	3.500
CU-4477	CU-4477-B	7.390	4.703	1.500	1.344	7.000	4.313	3.500	----	0.094	0.078	0.195	7.250	2.875	6.626	2.125
CU-4478	CU-4478-B	7.500	7.500	2.620	2.464	7.110	7.110	3.555	3.555	0.094	0.078	0.195	8.750	7.000	8.126	6.250
CU-4479	CU-4479-B	4.375	2.375	2.136	1.980	4.000	2.000	----	----	0.065	0.078	0.188	5.624	2.000	5.000	1.250