

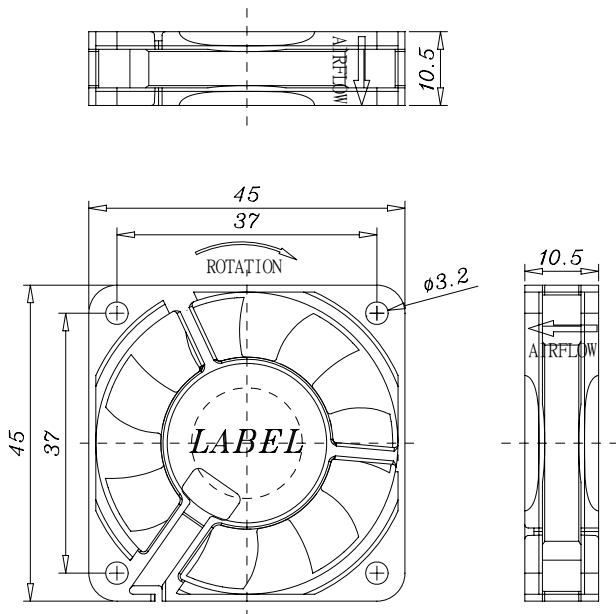
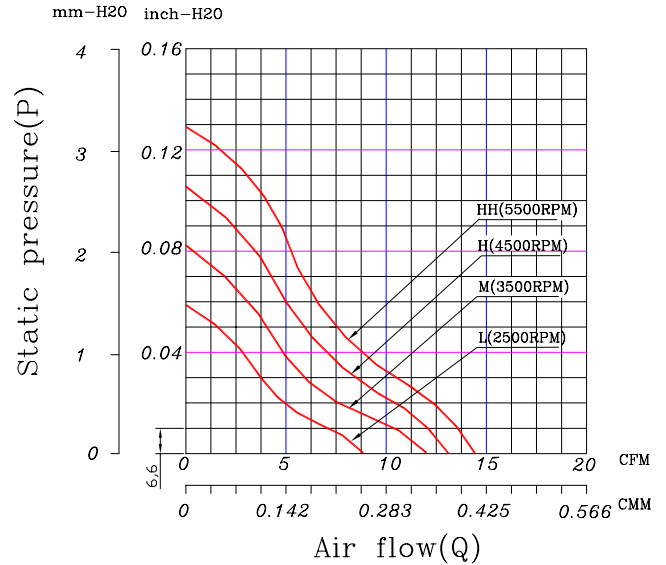

**45 x 45 x 10 mm Series**
**5 VDC**
**Dimensions**

**Performance Curves**

Air exhaust radial, through housing port. Rotational direction CW looking at rotor.

Brushless DC Motor	Bearing Type
Housing: PBT 94V0	● CeraDyna A
Impeller: PBT 94V0	● CeraDyna C
Weight: 15 g	● 2-Ball
Impedance protected	● 1-Ball-1-Sleeve
Lead wire UL 1095 AWG 28	● Sleeve

Function options	
● Frequency Generator	● Auto Restart
○ Temperature Control	● Rotation Detection
○ PWM Control	

\* Safety Approval: CE, UL, TUV

\*All fans are with electronic protection against reverse polarity. The fan only operates when the polarity is correct.

**Specifications**

Model	Rated Voltage (VDC)	Rated Current (Amp)	Input Power (Watts)	Nominal Speed (RPM)	Airflow (CFM)	Static Pressure (inch-H <sub>2</sub> O)	Noise Level (dBA)
FD0545-A00XXA	5	0.28	1.40	5500	13.48	0.13	33.00
FD0545-A10XXA	5	0.19	0.95	4500	11.03	0.10	27.00
FD0545-A20XXA	5	0.10	0.50	3500	8.58	0.08	23.00
FD0545-A30XXA	5	0.07	0.35	2500	6.13	0.06	20.00

\*All readings are typical value at rated voltage.

 \*Please refer to **PART NUMBER SYSTEM** for bearing type and part number "XX" designation.

\*Specifications are subject to change without prior notice.

\*Please specify revision number when ordering.