

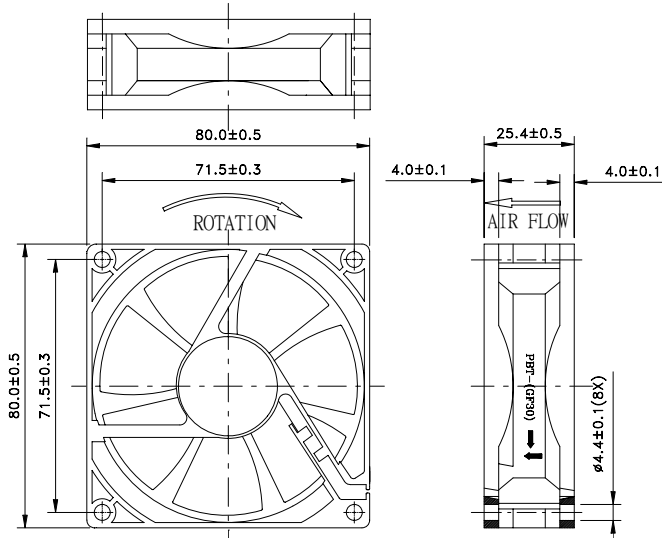
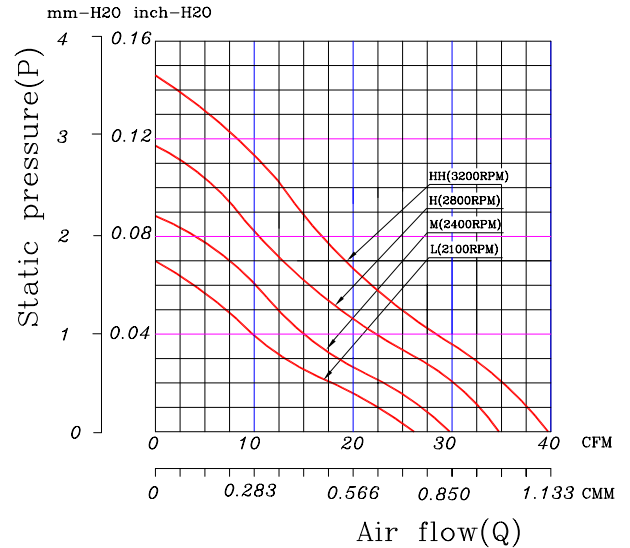

**80 x 80 x 25 mm Series**
**Rev I**
**Dimensions**

**Performance Curves**

Air exhaust over struts. Rotational direction CCW looking at rotor

Brushless DC Motor	Bearing Type
Housing: PBT 94V0	● CeraDyna A
Impeller: PBT 94V0	● CeraDyna C
Weight: 64 g	● 2-Ball
Impedance protected	● 1-Ball-1-Sleeve
Lead wire UL 1095 AWG 28	● Sleeve

Function options	
● Frequency Generator	● Auto Restart
● Temperature Control	● Rotation Detection
○ PWM Control	

\* Safety Approval: CE, UL, TUV

\* All fans are with electronic protection against reverse polarity. The fan only operates when the polarity is correct.

**Specifications**

Model	Rated Voltage (VDC)	Rated Current (Amp)	Input Power (Watts)	Nominal Speed (RPM)	Airflow (CFM)	Static Pressure (inch-H <sub>2</sub> O)	Noise Level (dBA)
FD1280-A00XXE	12	0.24	2.88	3200	39.73	0.14	34.00
FD1280-A10XXE	12	0.18	2.16	2800	34.75	0.12	32.00
FD1280-A20XXE	12	0.14	1.68	2400	29.77	0.09	26.50
FD1280-A30XXE	12	0.09	1.08	2100	26.17	0.07	23.50
FD2480-A00XXE	24	0.16	3.84	3200	39.73	0.14	34.00
FD2480-A10XXE	24	0.13	3.12	2800	34.75	0.12	32.00
FD2480-A20XXE	24	0.11	2.64	2400	29.77	0.09	26.50
FD2480-A30XXE	24	0.09	2.16	2100	26.17	0.07	23.50

\* All readings are typical value at rated voltage.

 \* Please refer to **PART NUMBER SYSTEM** for bearing type and part number "XX" designation.

\* Specifications are subject to change without prior notice.

\* Please specify revision number when ordering.