

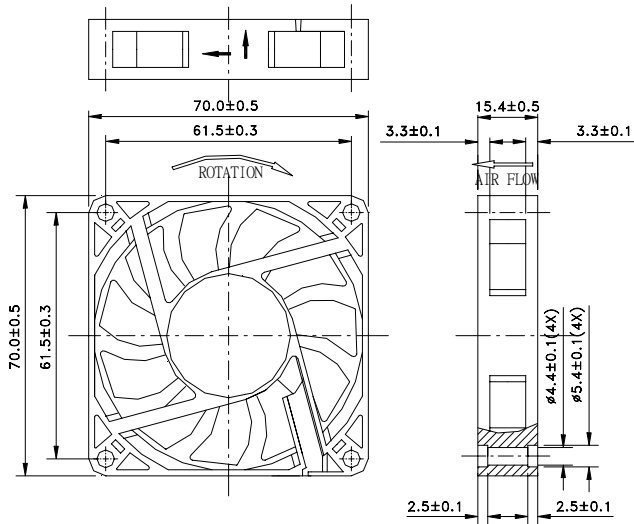
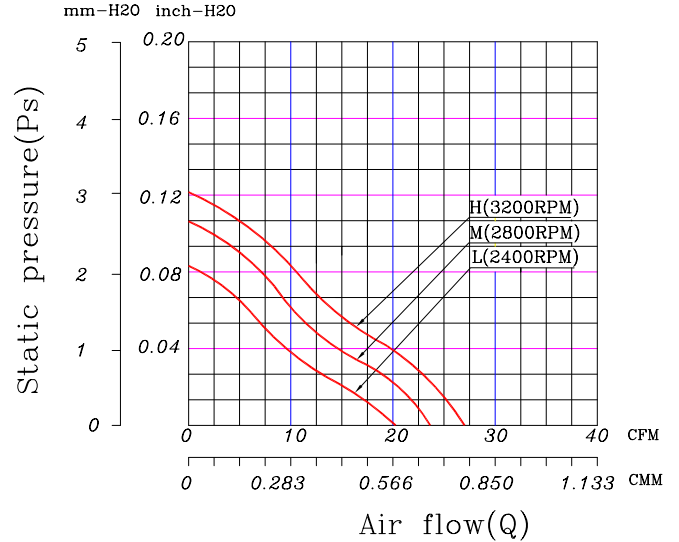

70 x 70 x 15 mm Series
Rev II-5VDC
Dimensions

Performance Curves

Air exhaust over struts. Rotational direction CCW looking at rotor

Brushless DC Motor	Bearing Type
Housing: PBT 94V0	● CeraDyna A
Impeller: PBT 94V0	● CeraDyna C
Weight: 47 g	● 2-Ball
Impedance protected	● 1-Ball-1-Sleeve
Lead wire UL 1095 AWG 28	● Sleeve

Function options	
● Frequency Generator	● Auto Restart
○ Temperature Control	● Rotation Detection
○ PWM Control	

* Safety Approval: CE, UL, TUV

* All fans are with electronic protection against reverse polarity. The fan only operates when the polarity is correct.

Specifications

Model	Rated Voltage (VDC)	Rated Current (Amp)	Input Power (Watts)	Nominal Speed (RPM)	Airflow (CFM)	Static Pressure (inch-H ₂ O)	Noise Level (dBA)
FD0570-A11XXC	5	0.27	1.35	3200	27.00	0.12	29.00
FD0570-A21XXC	5	0.21	1.05	2800	23.65	0.10	27.00
FD0570-A31XXC	5	0.18	0.90	2400	20.28	0.08	24.00

* All readings are typical value at rated voltage.

 * Please refer to **PART NUMBER SYSTEM** for bearing type and part number "XX" designation.

* Specifications are subject to change without prior notice.

* Please specify revision number when ordering.