

300mA, Micropower, VLDO Linear Regulator

UM175XX SOT23-5

General Description

The UM175XX series are VLDO (very low dropout) linear regulators designed for low power portable applications. Typical output noise is only $75\mu\text{V}_{\text{RMS}}$ and maximum dropout is just 90mV at the load current of 150mA. The internal P-channel MOSFET pass transistor requires no base current, allowing the device to draw only $100\mu\text{A}$ during normal operation at the maximum load current of 300mA.

Other features include high output voltage accuracy, excellent transient response, under voltage lockout, stability with ultralow ESR ceramic capacitors as small as $1\mu\text{F}$, reverse-battery protection, short-circuit and thermal overload protection and output current limiting.

The UM175XX series are available in a low profile SOT23-5 package.

Applications

- Bluetooth/802.11 Cards
- PDAs and Notebook Computers
- Portable Instruments and Battery-Powered Systems
- Cellular Phones

Features

- Very Low Dropout: 90mV(max) at 150mA
- Maximum Input Voltage: 6.0V
- Low Noise: $75\mu\text{V}_{\text{RMS}}$ (10Hz to 100kHz)
- $\pm 2\%$ Voltage Accuracy at 150mA
- Fast Transient Response
- Under Voltage Lockout
- Fixed Output Voltage:
3.3V/3.0V/2.8V/2.7V/2.5V/1.8V/1.5V/1.3V/
1.2V
- Output Current Limit
- Reverse-Battery Protection
- No Protection Diodes Needed
- Stable with $1\mu\text{F}$ Output Capacitor
- Short-Circuit and Thermal Overload Protection
- Low Profile SOT23-5 Package

Pin Configurations

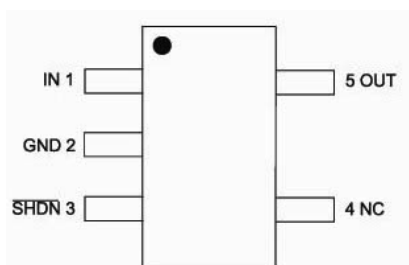

Top View

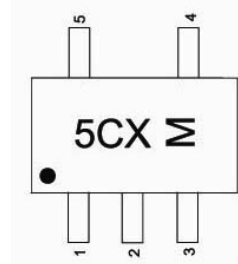

UM175XX
M: Monthly Code
SOT23-5

Ordering Information

Part Number	Output Voltage	Packaging Type	Marking Code	Shipping Qty
UM175415	4.15V	SOT23-5	5CY	3000pcs/7Inch Tape & Reel
UM17535	3.5V		5CZ	
UM17533	3.3V		5CU	
UM17530	3.0V		5CR	
UM17528	2.8V		5CQ	
UM17527	2.7V		5CP	
UM17525	2.5V		5CN	
UM17518	1.8V		5CK	
UM17515	1.5V		5CJ	
UM17513	1.3V		5CF	
UM17512	1.2V		5CE	

Pin Description

Pin Number	Symbol	Function
1	IN	Power Supply
2	GND	Ground
3	$\overline{\text{SHDN}}$	Shutdown Input, Active Low
4	NC	Not Connected
5	OUT	Voltage Regulated Output

Absolute Maximum Ratings (Note 1)

Symbol	Parameter	Value	Unit
V_{IN}	Supply Voltage on IN Pin	-7.5 to +7.5	V
$V_{\overline{\text{SHDN}}}$	Voltage on $\overline{\text{SHDN}}$ Pin	-0.3 to +7.5	V
V_{OUT}	Voltage on OUT Pin	-0.3 to +7.5	V
	Output Short-Circuit Duration	Indefinite	
T_{J}	Operating Junction Temperature (Notes 2, 3)	-40 to +125	°C
T_{STG}	Storage Temperature Range	-65 to +150	°C
T_{L}	Lead Temperature for Soldering 10 seconds	+300	°C

Note 1: Absolute Maximum Ratings are those values beyond which the life of a device may be impaired.

Note 2: The UM175XX is tested and specified under pulse load conditions such that $T_{\text{J}} \approx T_{\text{A}}$. The device is guaranteed to meet performance specifications from 0 °C to 70 °C. Specifications over the -40 °C to 125 °C operating junction temperature range are assured by design, characterization and correlation with statistical process controls.

Note 3: This IC includes overtemperature protection that is intended to protect the device during momentary overload conditions. Junction temperature will exceed 125 °C when overtemperature protection is active. Continuous operation above the specified maximum operating junction temperature may impair device reliability.

Electrical Characteristics

Symbol	Parameter	Test Conditions	Min	Typ	Max	Unit	
V_{IN}	Input Voltage Range		$V_{OUT}+$ V_{DROP}		6.0	V	
V_{UVLO1} (Note1)	Input Under Voltage Lockout	V_{IN} falling	2.0		2.6	V	
V_{UVLO2} (Note2)	Input Under Voltage Lockout	V_{IN} falling	2.1		2.3	V	
I_Q	Operating Quiescent Current	$I_{OUT}=0mA$		90		μA	
		$I_{OUT}=300mA$		100			
I_{SHDN}	Shutdown Leakage Current				1	μA	
	ESD Rating	Human Body Mode	2			KV	
I_{OUT}	Output Current		300			mA	
	Output Voltage Accuracy	$1mA \leq I_{OUT} \leq 150mA$, $T_A=+25^\circ C$	-1		+1	%	
		$1mA \leq I_{OUT} \leq 150mA$, $T_A=-40^\circ C$ to $+85^\circ C$	-2		+2		
		$1mA \leq I_{OUT} \leq 300mA$, $T_A=-40^\circ C$ to $+85^\circ C$	-2.5		+2.5		
ΔV_{DO}	Dropout Voltage	$I_{OUT}=150mA$			90	mV	
I_{LIMIT}	Output Current Limit	$V_{IN} \geq 2.5V$	450			mA	
t	Startup Time Response	$R_L=68\Omega$, $C_{OUT}=1\mu F$		20		μs	
V_{IL}	\overline{SHDN} Input Low Voltage				$0.3 \times V_{IN}$	V	
V_{IH}	\overline{SHDN} Input High Voltage		$0.7 \times V_{IN}$			V	
	\overline{SHDN} Input Current	$\overline{SHDN}=V_{IN}$ or GND	-1	0.1	+1	μA	
T_{SHDN}	Thermal-Shutdown Temperature			160		$^\circ C$	
ΔT_{SHDN}	Thermal-Shutdown Hysteresis			20		$^\circ C$	
	Line Regulation	$V_{OUT}+1V \leq V_{IN} \leq V_{OUT}+2V$ $I_{OUT}=10mA$		0.09		%/V	
	Load Regulation	$V_{IN}=V_{OUT}+1V$ $1mA \leq I_{OUT} \leq 150mA$		0.2		%	
	Output Voltage Noise	10Hz to 100KHz $C_{IN}=0.1\mu F$, $I_{OUT}=10mA$		75		μV_{RMS}	
PSRR	Power Supply Ripple Rejection	$V_{IN}=V_{OUT}+1V$ $I_{OUT}=100mA$	F=100Hz	70			dB
			F=1KHz	65			
			F=10KHz	50			
			F=100KHz	40			

Note1: V_{UVLO1} is measured for devices with $V_{OUT} \geq 1.8V$.

Note2: V_{UVLO2} is measured for devices with $V_{OUT} \leq 1.5V$.

Note3: ΔV_{DO} just define for device with $V_{OUT} \geq 2.5V$.

Pin Function

IN (Pin 1): Power for UM175XX and Load. Power is supplied to the devices through the IN pin. The IN pin should be locally bypassed to ground if the UM175XX series are more than a few inches away from another source of bulk capacitance. In general, the output impedance of a battery rises with frequency, so it is usually advisable to include an input bypass capacitor in battery-powered circuits. A capacitor in the range of $0.1\mu\text{F}$ to $1\mu\text{F}$ is usually sufficient. The UM175XX series are designed to withstand reverse voltages on the IN pin with respect to both ground and the output pin. In the case of a reversed input, which can happen if a battery is plugged in backwards, the UM175XX will act as if there is a large resistor in series with its input with only a small amount of current flow.

GND (Pin 2): Ground and Heat Sink. Solder to a ground plane or large pad to maximize heat dissipation.

$\overline{\text{SHDN}}$ (Pin 3): Shutdown, Active Low. This pin is used to put the UM175XX into shutdown. The $\overline{\text{SHDN}}$ pin cannot be left floating and must be tied to the input pin if not used.

NC (Pin 4): Not Connected.

OUT (Pin 5): Voltage Regulated Output. The OUT pin supplies power to the load. A minimum output capacitor of $1\mu\text{F}$ is required to ensure stability. Larger output capacitors may be required for applications with large transient loads to limit peak voltage transients. See the Applications Information section for more information on output capacitance.

Typical Application Circuit

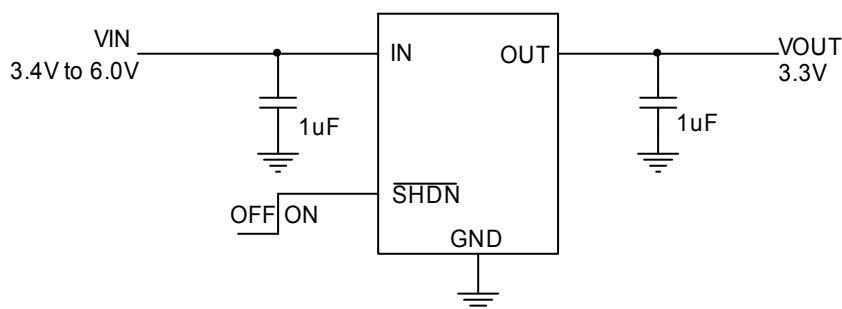

Typical Performance Characteristics

Quiescent Current vs Input Voltage

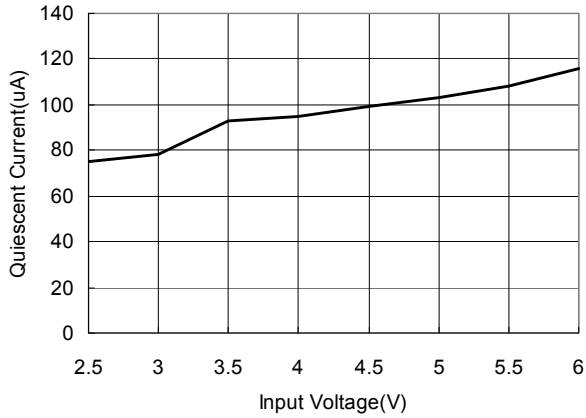

Output Voltage vs Output Current

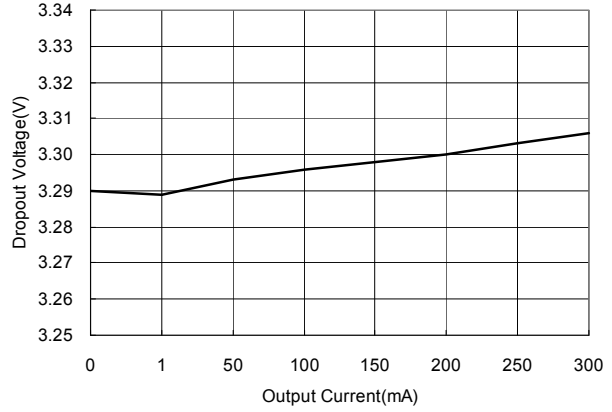

Dropout Voltage vs Output Current

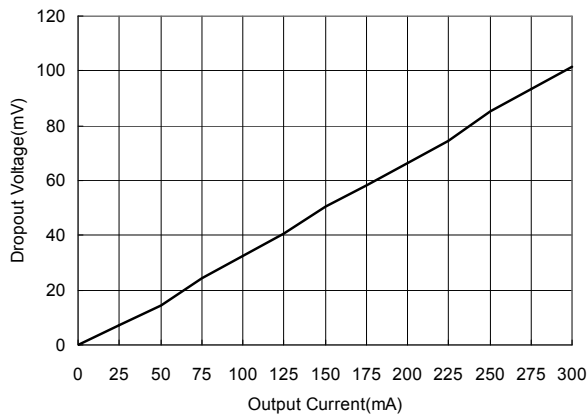

Output Voltage vs Output Current

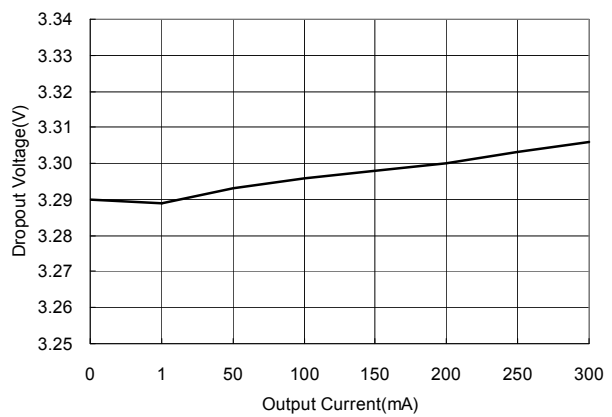

Line Transient Response

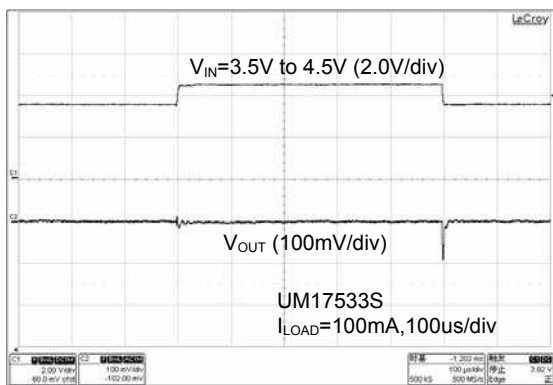

Load Transient Response

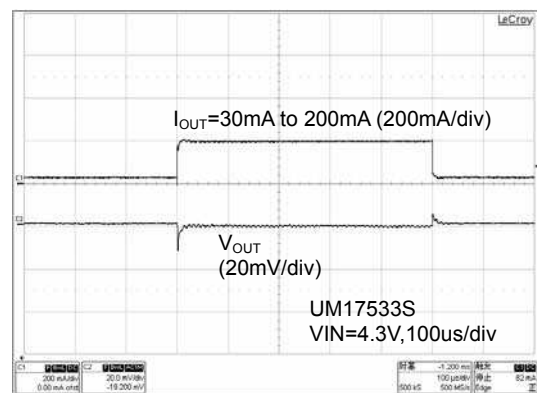

Package Information

UM175XX: SOT23-5

Outline Drawing

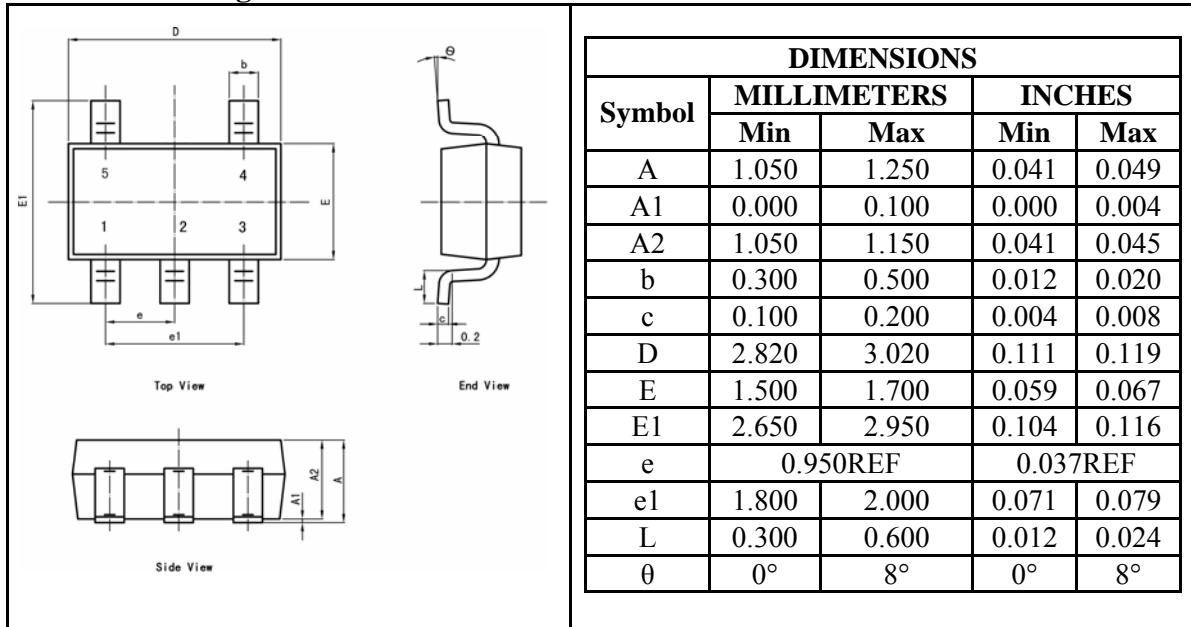

Land Pattern

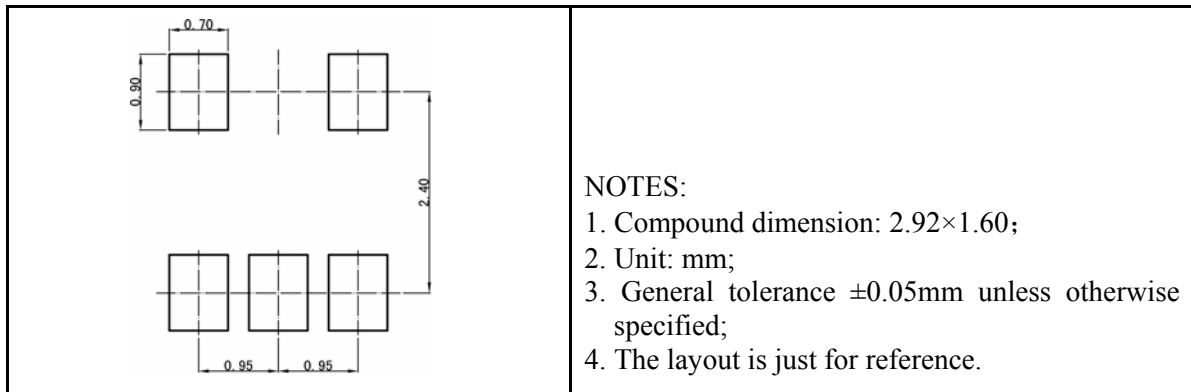

Tape and Reel Orientation

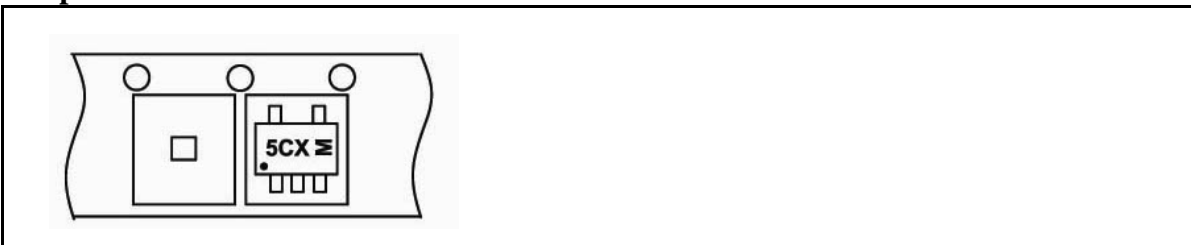

IMPORTANT NOTICE

The information in this document has been carefully reviewed and is believed to be accurate. Nonetheless, this document is subject to change without notice. Union assumes no responsibility for any inaccuracies that may be contained in this document, and makes no commitment to update or to keep current the contained information, or to notify a person or organization of any update. Union reserves the right to make changes, at any time, in order to improve reliability, function or design and to attempt to supply the best product possible.



Union Semiconductor, Inc

Add: 2F, No. 3, Lane 647 Songtao Road, Shanghai 201203

Tel: 021-51093966

Fax: 021-51026018

Website: www.union-ic.com