

LUXEON Flash 7

Power Light Source

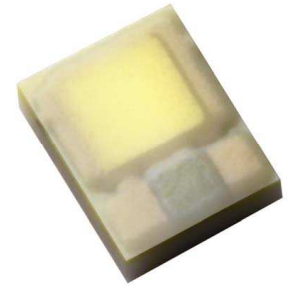

LXCL-EY17



Introduction

LUXEON® Flash 7 is a family of ultra-compact LEDs specifically designed and tested for use as a camera flash in space-constrained and portable digital imaging applications. LUXEON Flash emitters are designed with innovative LUXEON technology to provide industry-leading intensity and uniformity. The uniquely bright source density characteristics of LUXEON Flash products put more light on scene, enabling higher quality pictures in low ambient lighting conditions at greater distances. Portable imaging devices including camera-equipped smart phones, tablets and digital still cameras can easily incorporate the slim form factor of the LUXEON Flash into sleek designs while maintaining high levels of light output.

The compact and well-defined light source geometry of LUXEON Flash 7 LEDs allows their light to be easily coupled into secondary optics or integrated into a stand-alone camera Flash module so that time-to-market can be accelerated with simplified designs. An integrated transient voltage suppression (TVS) chip provides ESD protection up to 8kV.

Features

- High flux density with compact light emitting source
- Off-State White appearance
- Rated 1.5 A max pulse current
- Tight Correlated Color Temperature control
- Pb Free / RoHS compliant
- MSL (moisture sensitivity level) class 1 rating

Benefits

- Enables efficient illuminating optics with compact footprint
- Aesthetically pleasing for device industrial design
- Enables maximum utilization of output capabilities
- Ensures consistency in system color point
- Free of hazardous materials
- Indefinite shelf life*

* Per IPC/JEDEC J-STD-20 MSL Classifications

Table of Contents

General Information	2
Ordering Information	2
Environmental Compliance	2
Product Performance and Characterization Guide.	3
Electrical Characteristics	3
Absolute Maximum Ratings	4
JEDEC Moisture Sensitivity	4
Forward Current Characteristics	5
Reflow Soldering Temperature Profile.	6
Mechanical Dimensions	7
Circuit Diagram	7
Solder Pad Design	8
Typical Relative Spectral Distribution vs. Wavelength.	9
Typical Relative Radiation Pattern	9
Typical Light Output Characteristics.	10
Typical Forward Voltage Characteristics	11
CCT Shift vs. Forward Current.	12
Color Specifications.	13
Chromaticity Coordinate Shift vs. Forward Current	14
Color Over Angle	14
Emitter Pocket Tape Packaging.	15
Emitter Reel Packaging.	15

General Information

Ordering Information

Part Number	Description	Package Quantity
LXCL-EY17-xxxx	LUXEON Flash 7 Emitter; off-state white, on-state cool-white, 1mm ² die size	5000

Environmental Compliance

Philips Lumileds is committed to providing environmentally friendly products to the solid-state lighting market. LUXEON Flash is compliant to the European Union directives on the restriction of hazardous substances in electronic equipment, namely the RoHS and REACH directives. Philips Lumileds will not intentionally add the following restricted material to the LUXEON Flash: lead, mercury, cadmium, hexavalent chromium, polybrominated biphenyls (PBB) or polybrominated diphenyl ethers (PBDE).

Product Performance and Characterization Guide

Optical Characteristics

Table 1.

Part Number	Luminous Flux ² (Lm)		Color Temperature ³ (CCT)			Typical Viewing Angle ⁴ (degrees)
	Min.	Typ.	Min.	Typ.	Max.	20 1/2
LXCL-EY17-xxxx	220	260	5500	6000	6500	120

Notes for Table 1:

1. Electro-optical testing conducted in single pulse mode, $T_{ON} = 20$ ms, $T_J = 25^\circ\text{C}$, $I_F = 1000$ mA.
2. Philips Lumileds maintains a tester tolerance of $\pm 10\%$ on luminous flux measurements.
3. Philips Lumileds maintains a tester tolerance of $\pm 5\%$ on CCT measurements.
4. Viewing angle is the off axis angle from LED centerline where the luminous intensity is $1/2$ of the peak value.

Electrical Characteristics

Table 2.

Part Number	Forward Voltage V_f ^[2] (V)			Typical Temperature Coefficient of Forward Voltage ^[3] (mV/°C) $\Delta V_f / \Delta T_J$	Typical Thermal Resistance Junction to Thermal Pad (°C/W) $R_{\theta_{J-C}}$	Typical Dynamic Resistance ^[4] (Ω) $\Delta V_f / \Delta I_F$
	Minimum	Typical	Maximum			
LXCL-EY17-xxxx	2.7	3.2	3.6	-2	10	0.17

Notes for Table 2:

1. Electro-optical testing conducted in single pulse mode, $T_{ON} = 20$ ms, $T_J = 25^\circ\text{C}$, $I_F = 1000$ mA.
2. Philips Lumileds maintains a tolerance of $\pm 0.06\text{V}$ on forward voltage measurements.
3. Measured between $T_J = 25^\circ\text{C}$ and $T_J = 85^\circ\text{C}$ at $I_f = 1000$ mA.
4. Dynamic resistance is the inverse of the slope in the I_f vs. V_f curve and is measured at $I_f = 1000$ mA (see Figure 11).

Absolute Maximum Ratings

Table 3.

Parameter	LUXEON Flash 7
DC (Torch Mode) Forward Current	500 mA
Peak Pulsed (Flash Mode) Forward Current ^[1]	1500 mA
ESD Sensitivity	≤ 8000V Human Body Model (HBM) Class 3B JESD22-A114 ≤ 500V Charged-Device Model (CDM) Class 3 JESD22-C101
Storage Temperature ^[2]	-40°C - 85°C
LED Junction Temperature ^[3,4] (DC / pulse)	135°C / 150°C
LED Case Temperature ^[4] (DC / pulse)	115°C / 135°C
LED Operating Temperature (Ambient)	-30°C - 85°C
Reverse Voltage	LUXEON Flash LEDs are not designed to be driven in reverse bias

Notes for Table 3:

1. Peak pulsed forward current applies to $T_{ON} \leq 200\text{ms}$ and 30% maximum duty cycle or $T_{ON} \leq 500\text{ms}$ and 10% maximum duty cycle.
2. Maximum storage temperature with RH < 85%.
3. Junction Temperature is based on calculation from measured LED case temperature.
4. Pulse conditions assume 10% duty cycle.

JEDEC Moisture Sensitivity

Table 4. IPC/JEDEC J-STD-20 (MSL)

Level	Floor Life		Soak Requirements Standard	
	Time	Conditions	Time	Conditions
I	Unlimited	≤ 30°C / 85% RH	168 Hrs.	85°C / 85% RH

Forward Current Characteristics

Maximum Current vs. Forward Current Pulse On-Time

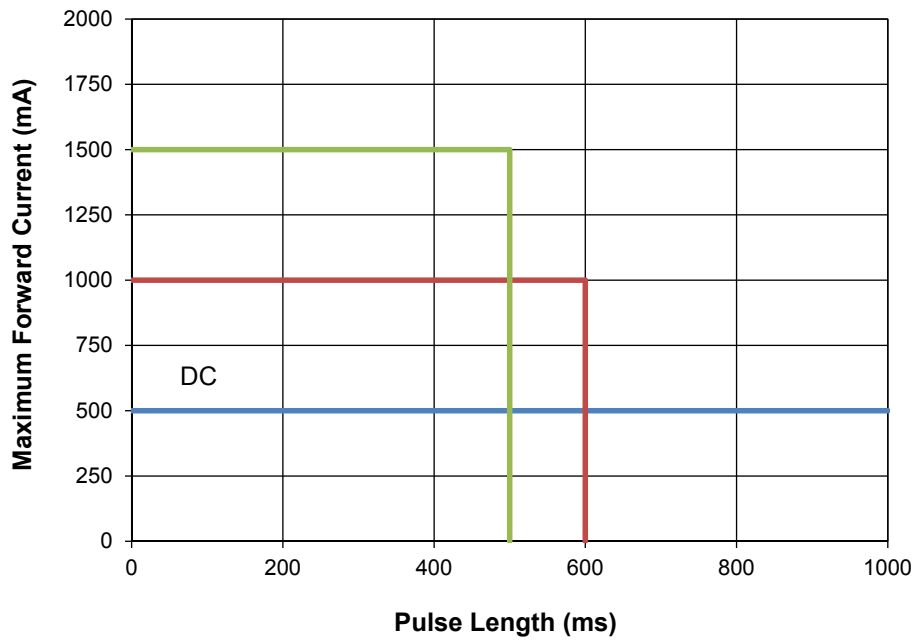

Figure 1.

Maximum Current vs. LED Junction Temperature

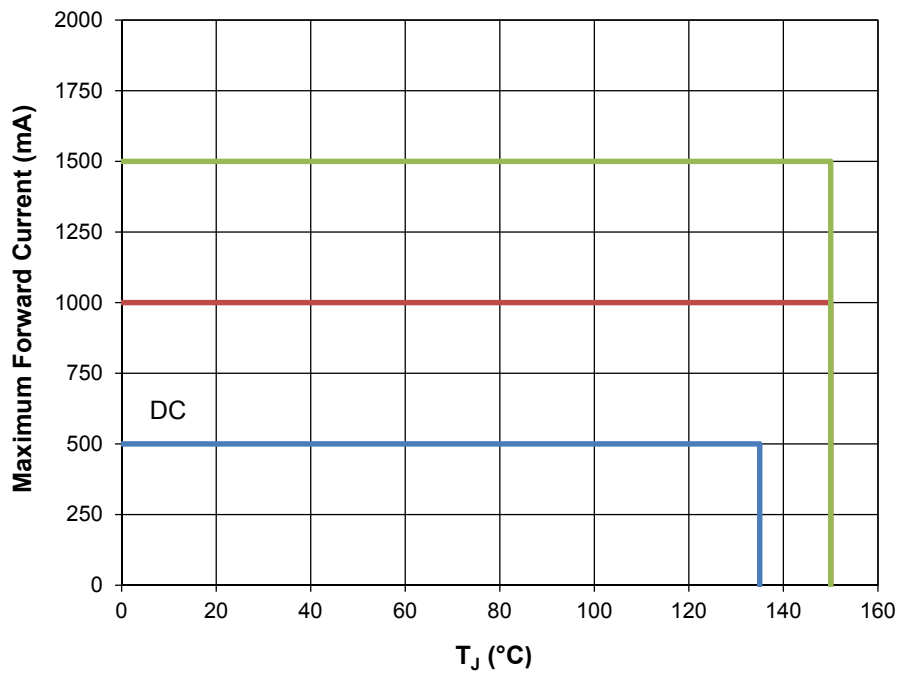

Figure 2.

Note for Figures 1 and 2:

1. Peak pulsed forward current of 1500 mA applies to $T_{ON} \leq 200ms$ and 30% maximum duty cycle or $T_{ON} \leq 500ms$ and 10% maximum duty cycle.
2. Peak pulsed forward current of 1000 mA applies to $T_{ON} \leq 600ms$ and 10% maximum duty cycle.

Reflow Soldering Temperature Profile

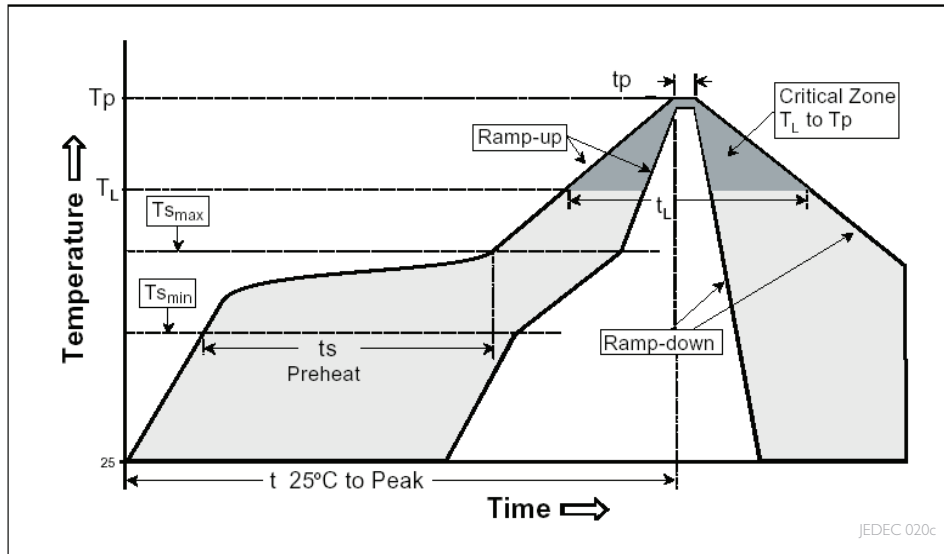

Table 5.

Profile Feature	Lead Free Assembly
Average Ramp-Up Rate ($T_{s_{max}}$ to T_p)	3°C / second max
Preheat Temperature Min ($T_{s_{min}}$)	150°C
Preheat Temperature Max ($T_{s_{max}}$)	200°C
Preheat Time ($t_{s_{min}}$ to $t_{s_{max}}$)	60 - 180 seconds
Temperature (T_l)	217°C
Time Maintained Above Temperature (t_l)	60 - 150 seconds
Peak / Classification Temperature (T_p)	260°C
Time Within 5°C of Actual Peak Temperature (t_p)	20 - 40 seconds
Ramp-Down Rate	6°C / second max
Time 25°C to Peak Temperature	8 minutes max

Note for Table 5:

I. All temperatures refer to the application Printed Circuit Board (PCB), measured on the surface adjacent to the package body.

Mechanical Dimensions

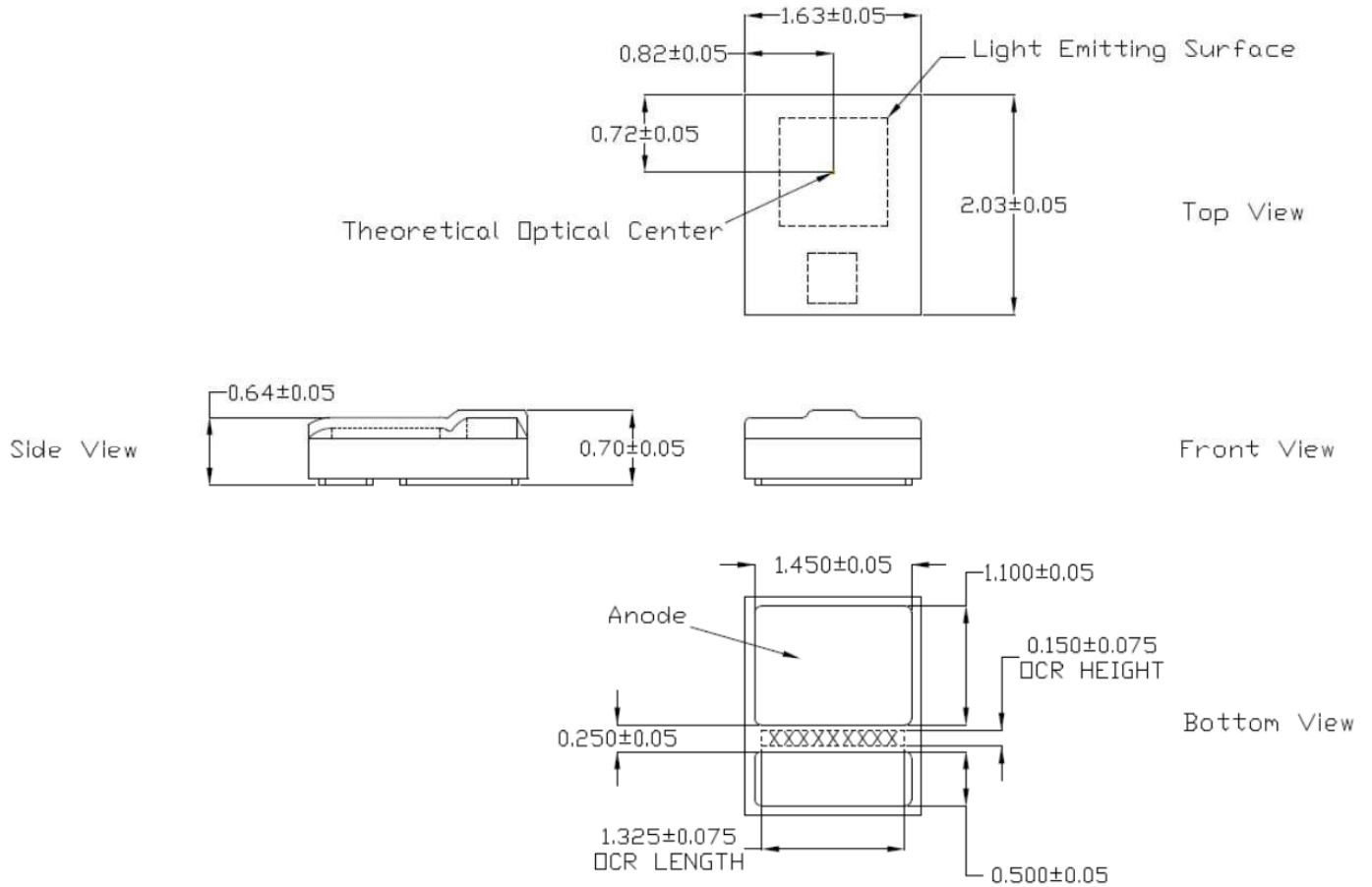

Figure 3. Dimensions for LXCL-EY17-xxxx.

Notes for Figure 3:

1. Drawings not to scale.
2. All dimensions in millimeters.

Circuit Diagram

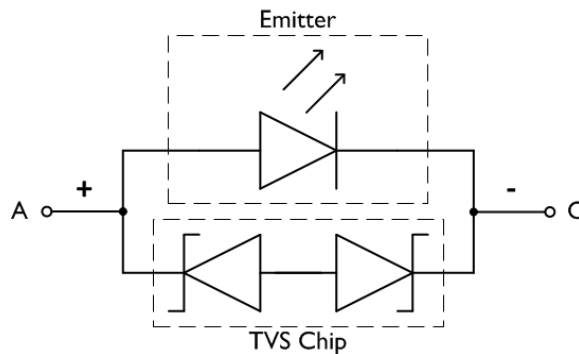

Figure 4.

Solder Pad Design

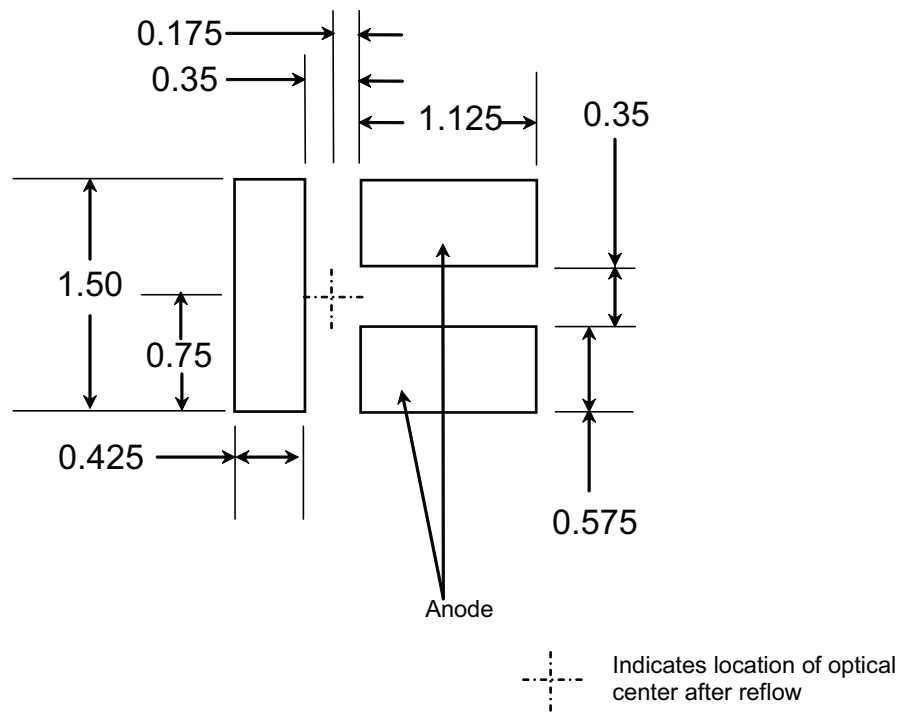

Figure 5.

Notes for Figure 5:

1. Recommended layout for LXCL-EY17-xxxx on printed circuit board (PCB).
2. All dimensions are in millimeters.
3. All tolerances ± 0.05 mm.
4. Solder pads are designed to achieve optimum positional accuracy using standard reflow processes.
5. Design should include adequate thermal heat sinking.

Typical Relative Spectral Distribution vs. Wavelength

Test Current at 1000 mA, Junction Temperature = 25°C

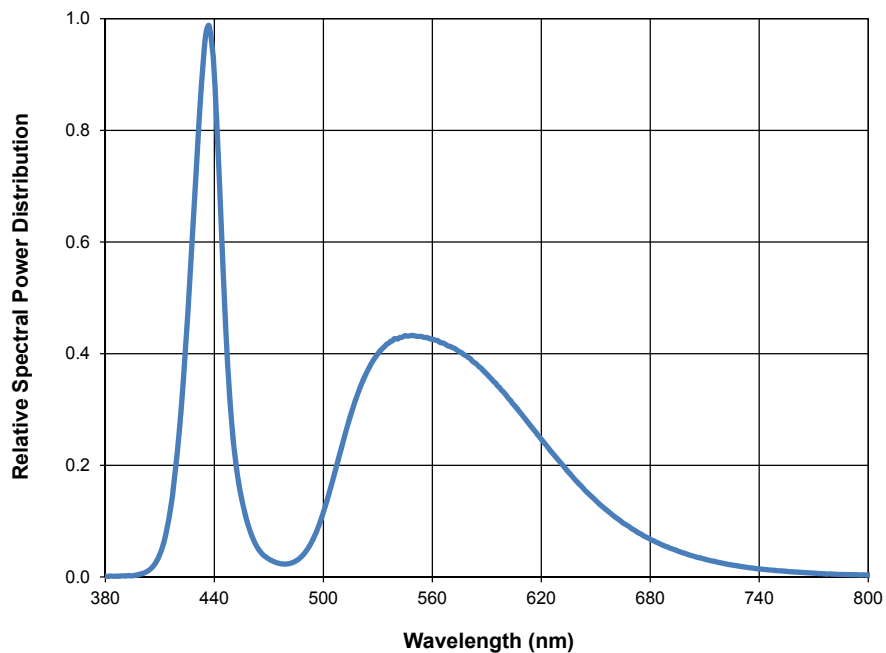

Figure 6.

Typical Relative Radiation Pattern

Test Current at 1000 mA, Junction Temperature = 25°C

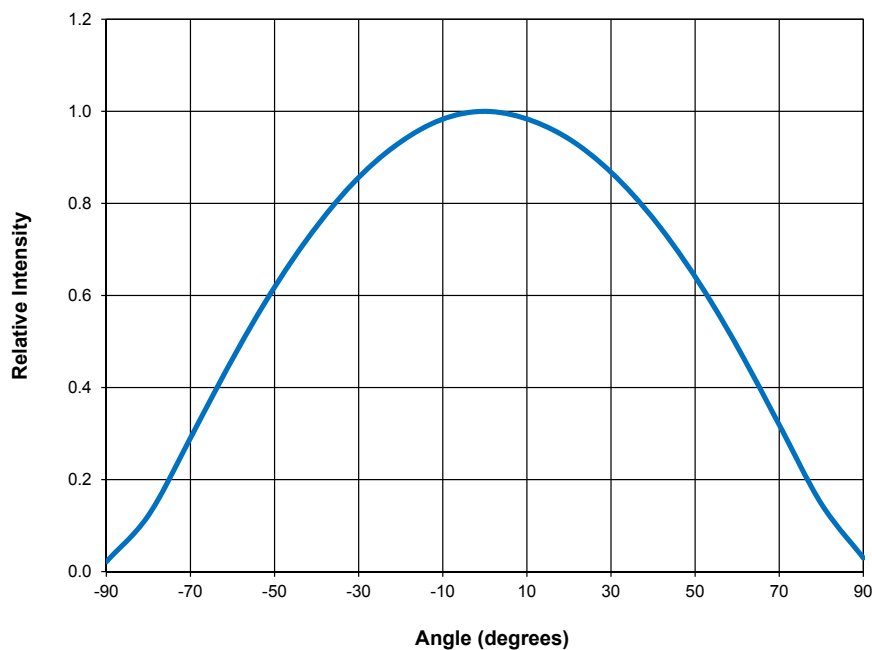

Figure 7.

Typical Light Output Characteristics

Typical Relative Light Output vs. Junction Temperature, Test Current at 1000 mA

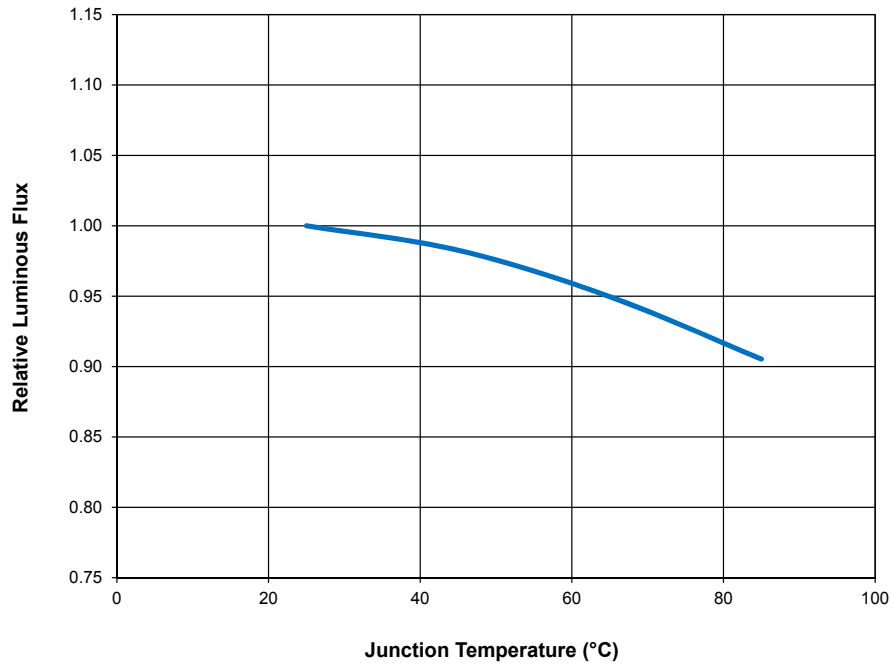

Figure 8.

Relative Light Output vs. Forward Current, Junction Temperature = 25°C

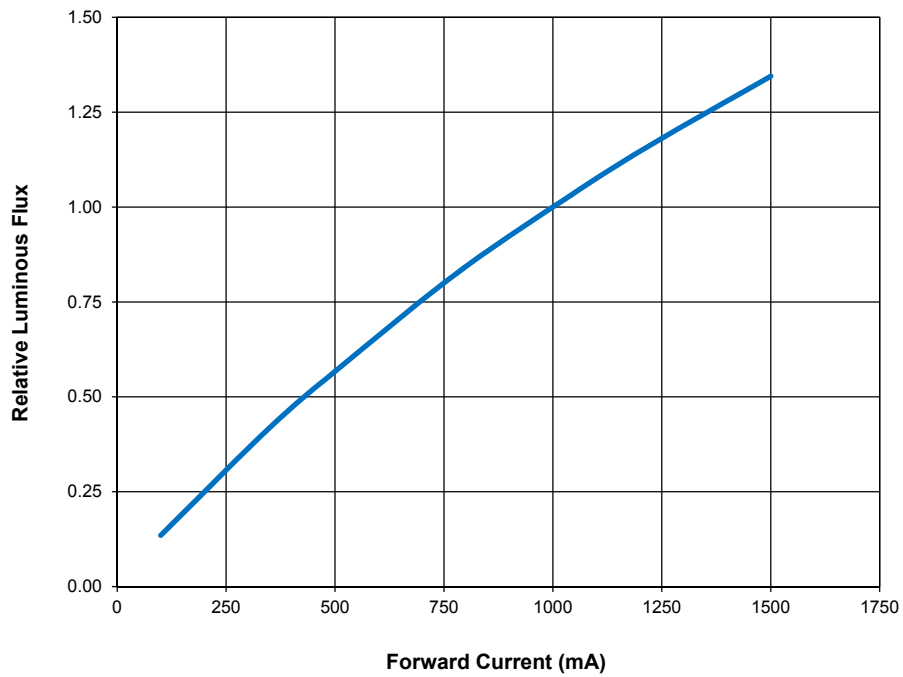

Figure 9.

Note for Figures 8 and 9:

1. A typical relative luminous flux of 1.0 refers to nominal conditions (see Table 1).

Typical Forward Voltage Characteristics

Typical Forward Current vs. Forward Voltage, Junction Temperature = 25°C

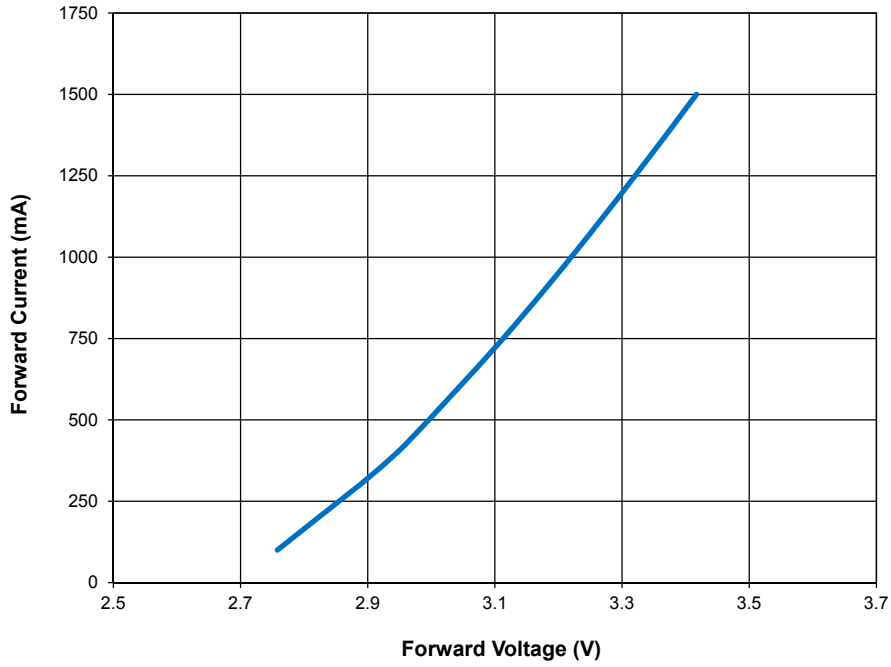

Figure 10.

Forward Voltage Shift vs. Junction Temperature, Test Current at 1000 mA

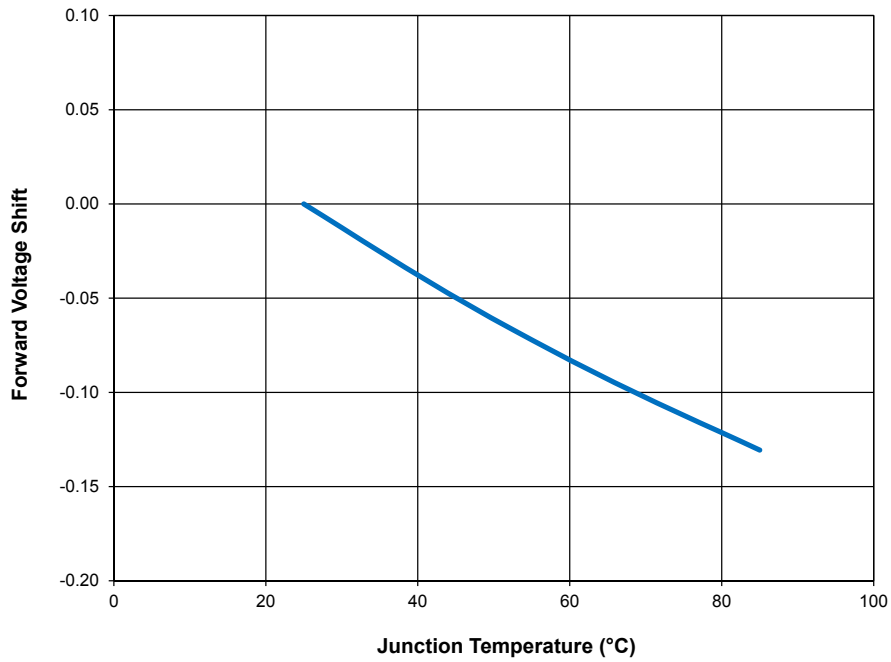

Figure 11.

Note for Figure 11:

I. A forward voltage shift of 0.0 refers to nominal conditions (see Table 2).

CCT Shift vs. Forward Current

Junction Temperature = 25°C

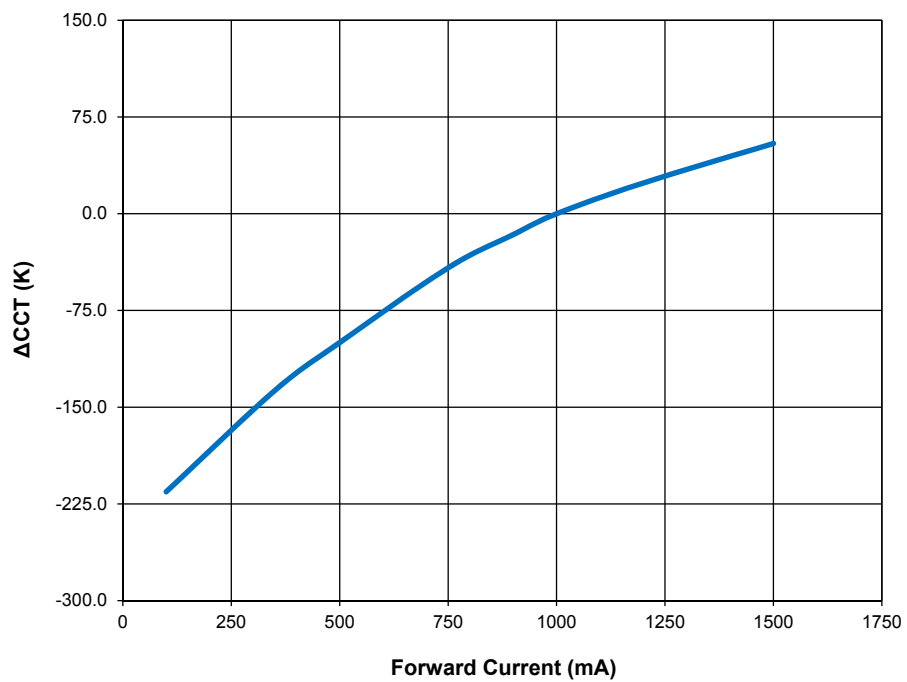

Figure 12.

Note for Figure 12:

1. A CCT shift of 0.0 refers to nominal conditions (see Table 1).

Color Specifications

Test Current at 1000 mA, Junction Temperature = 25°C

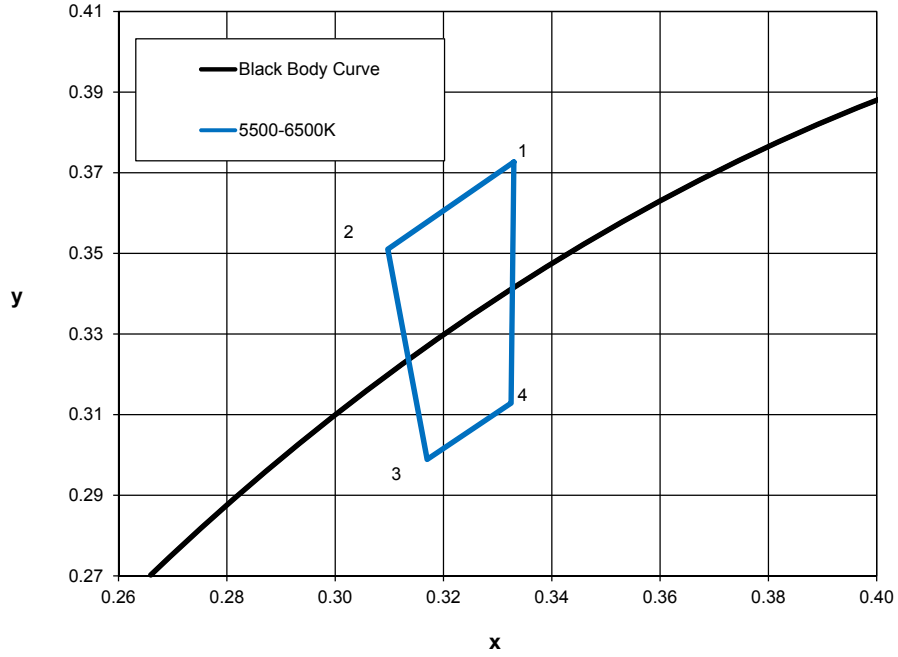

Figure 13. C.I.E. 1931 Chromaticity diagram.

Table 6. Chromaticity Coordinates

Point	x	y
1	0.3330	0.3727
2	0.3097	0.3511
3	0.3170	0.2989
4	0.3325	0.3129

Chromaticity Coordinate Shift vs. Forward Current

Junction Temperature = 25°C

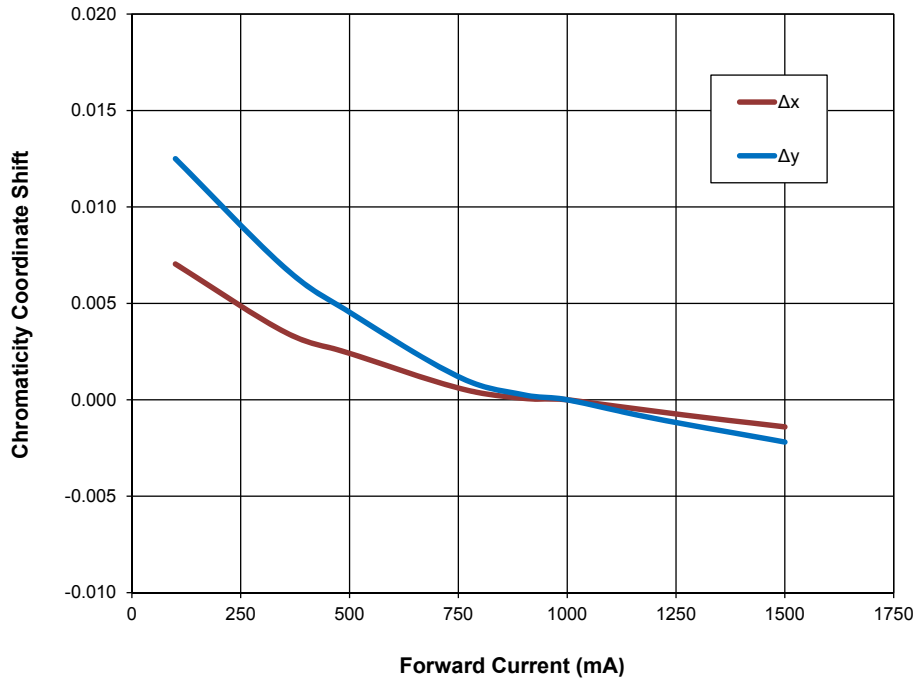

Figure 14.

Color Over Angle

Test Current at 1000 mA, Junction Temperature = 25°C

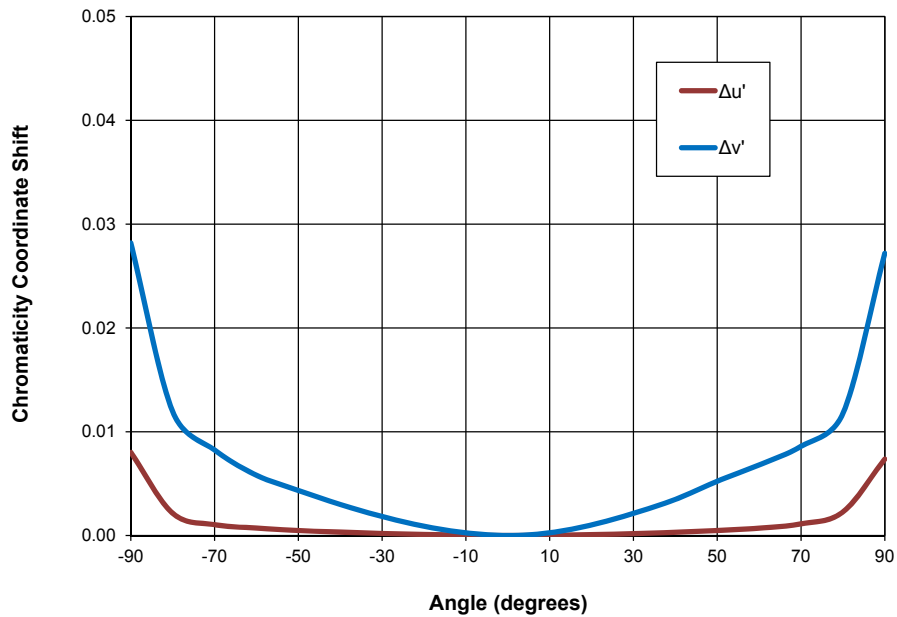

Figure 15.

Notes for Figure 15:

1. $u'v'$ coordinates based on C.I.E. 1976 Chromaticity Diagram.
2. Philips Lumileds optimizes its phosphor composition to achieve uniform conversion of white colored light as a function of emission angle.
3. Angle corresponds to the spatial radiation pattern of the emitter (see Figure 7).

Emitter Pocket Tape Packaging

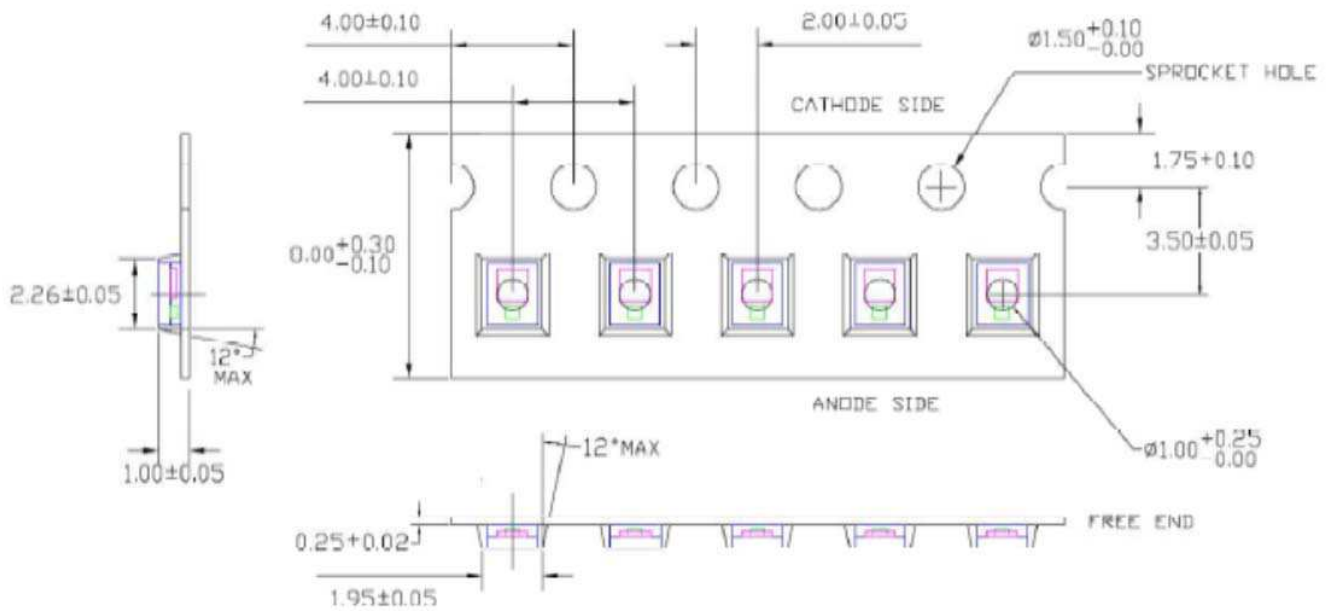

Figure 16. Tape dimensions.

Emitter Reel Packaging

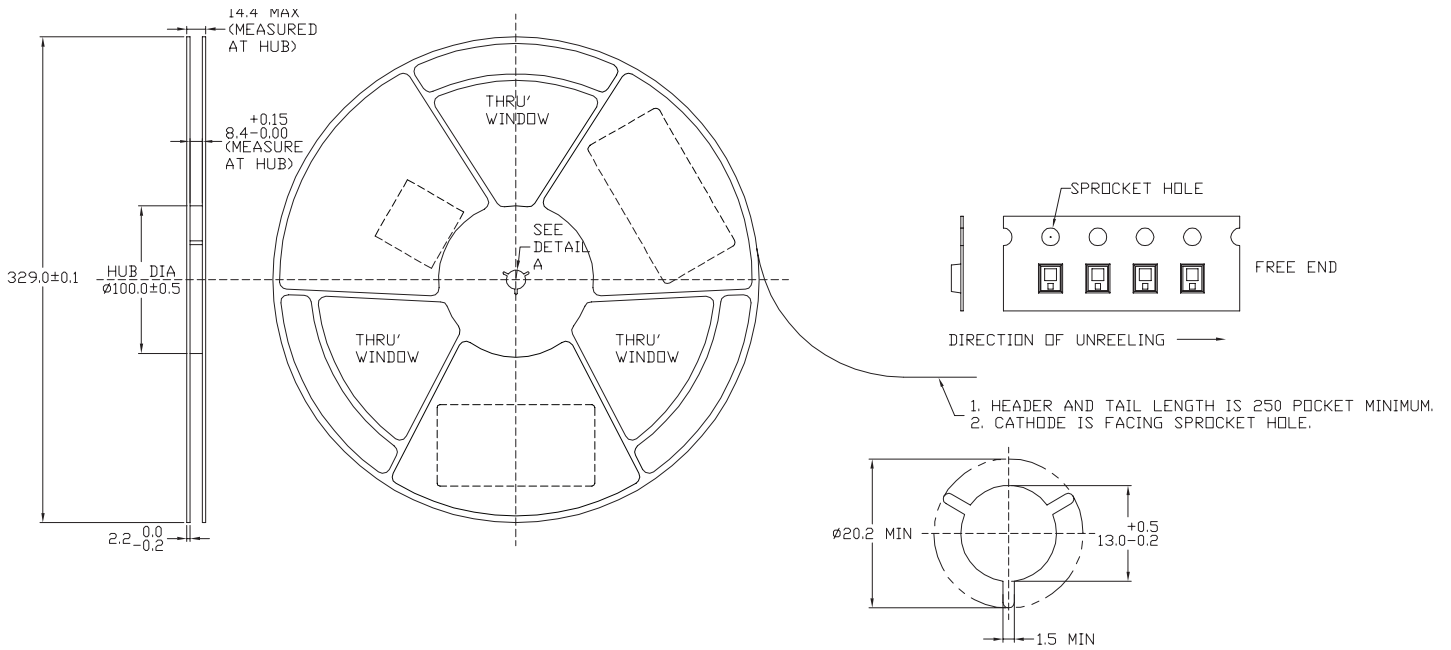

Figure 17. Emitter reel packaging.

Company Information

Philips Lumileds is a leading provider of LEDs for everyday lighting applications. The company's records for light output, efficacy and thermal management are direct results of the ongoing commitment to advancing solid-state lighting technology and enabling lighting solutions that are more environmentally friendly, help reduce CO2 emissions and reduce the need for power plant expansion. Philips Lumileds LUXEON® LEDs are enabling never before possible applications in outdoor lighting, shop lighting, home lighting, digital imaging, display and automotive lighting.

Philips Lumileds is a fully integrated supplier, producing core LED material in all three base colors, (Red, Green, Blue) and white. Philips Lumileds has R&D centers in San Jose, California and in the Netherlands, and production capabilities in San Jose, Singapore and Penang, Malaysia. Founded in 1999, Philips Lumileds is the high flux LED technology leader and is dedicated to bridging the gap between solid-state technology and the lighting world. More information about the company's LUXEON LED products and solid-state lighting technologies can be found at www.philipslumileds.com.



Philips Lumileds Lighting Company shall not be liable for any kind of loss of data or any other damages, direct, indirect or consequential, resulting from the use of the provided information and data. Although Philips Lumileds Lighting Company has attempted to provide the most accurate information and data, the materials and services information and data are provided "as is" and Philips Lumileds Lighting Company neither warranties, nor guarantees the contents and correctness of the provided information and data. Philips Lumileds Lighting Company reserves the right to make changes without notice. You as user agree to this disclaimer and user agreement with the download or use of the provided materials, information and data.



©2013 Philips Lumileds Lighting Company. All rights reserved.
LUXEON is a registered trademark of the Philips Lumileds Lighting Company in the United States and other countries.

www.philipslumileds.com
www.philipslumileds.cn.com

LUXEON Flash 7 EY17 Datasheet DS121 20130613