

Item Number 1038927
 Item Description e03-03-015-0808-3-200-0.22-SI-SMA-1.5-KL
 Model e03.0150808200

Pilot⁴
 EAR99⁵

	Units	Lower Spec	Typical	Upper Spec
Optical				
CW Output Power ⁶	W		15	
Centroid Wavelength	nm	805	808	811
Spectral Width (FWHM)	nm		2.0	4.0
Slope Efficiency	W / A		3.0	
Power within 0.17 NA	%	90		
Fiber Core / Clad Diameter	μm		200 / 220	
Fiber NA / Index Type	-		0.22 NA / Step Index	
Electrical				
Electrical-to-Optical Efficiency	%	44	47	
Threshold Current	A		1.3	
Operating Current	A		6.1	6.8
Operating Voltage	V		5.1	5.5
Mechanical				
Mass	g		60	
Fiber Length	m	1.0	1.5	
Active Fiber Bend Radius	mm	50		
Fiber Jacketing	-		3 mm Kevlar Strand Furcation Tubing	
Fiber Termination	-		SMA	
Thermal				
Thermal Resistance	°C / W		1.1	
Waste Heat	W		16	
Operating (Housing) Temperature ^{2,3}	°C	+20	+25	+35
Wavelength Temperature Coefficient	nm / °C		0.28	
Wavelength Current Coefficient	nm / A		0.7	

Outline Drawing (Package Dimension 46 x 24.5 x 10.1 mm)

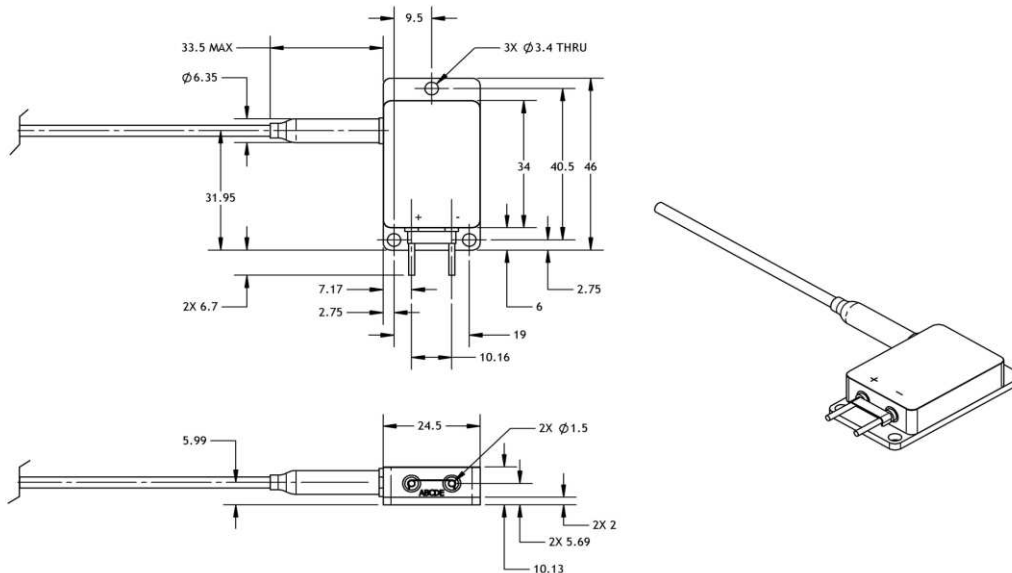

Notes

- ¹ Production specification shown are for beginning of life performance, end of life operating current (lop) is 120% beginning of life lop
- ² A non-condensing environment is required for operation and storage. Storage conditions are from -20 to +70 °C with relative humidity between 5 to 85 %
- ³ Operating temperature defined by the package housing
- ⁴ Current phase within the nLIGHT's NPI (New Production Introduction) Process
- ⁵ Export Control Classification Number (ECCN) as defined by the Export Administration Regulations (EAR)
- ⁶ Reported power is with an uncoated distal fiber end, therefore will be ~ 3.5 % higher if spliced

IEC Regulation
 This laser does NOT comply with IEC 60825-1 or 21 CFR 1040 for complete laser products and is solely intended to be integrated in a certified laser product.



Notice
 nLIGHT continually improves its products to provide customers with outstanding quality and reliability, therefore may change certain specifications and product descriptions at any time, without notice. Additionally, nLIGHT offers a limited warranty to ensure customer satisfaction. For complete details, please contact an



nLight Corporation
 5408 NE 88th Street, Bldg E
 Vancouver, Washington 98665
 United States of America
 Phone: 866.202.4488
 360.566.4460
 Fax: 360.546.1960
 e-mail: sales@nlight.net
 web: www.nlight.net