

MECHANICAL DATA

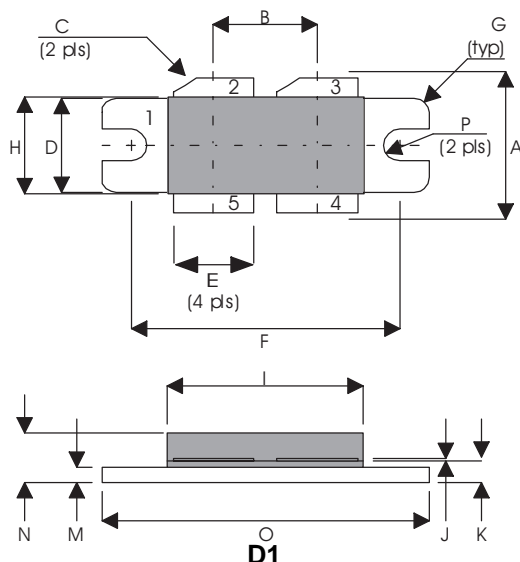

PIN 1 SOURCE (COMMON) PIN 2 DRAIN 1
 PIN 3 DRAIN 2 PIN 4 GATE 2
 PIN 5 GATE 1

DIM	Millimetres	Tol.	Inches	Tol.
A	15.24	0.50	0.600	0.020
B	10.80	0.13	0.425	0.005
C	45°	5°	45°	5°
D	9.78	0.13	0.385	0.005
E	8.38	0.13	0.330	0.005
F	27.94	0.13	1.100	0.005
G	1.52R	0.13	0.060R	0.005
H	10.16	0.15	0.400	0.006
I	21.84	0.23	0.860	0.009
J	0.10	0.02	0.004	0.001
K	1.96	0.13	0.077	0.005
M	1.02	0.13	0.040	0.005
N	4.45	0.38	0.175	0.015
O	34.04	0.13	1.340	0.005
P	1.63R	0.13	0.064R	0.005

GOLD METALLISED
MULTI-PURPOSE SILICON
DMOS RF FET
300W – 28V – 175MHz
PUSH-PULL

FEATURES

- SUITABLE FOR BROAD BAND APPLICATIONS
- SIMPLE BIAS CIRCUITS
- ULTRA-LOW THERMAL RESISTANCE
- BeO FREE
- LOW Crss
- HIGH GAIN – 16 dB MINIMUM

APPLICATIONS

- VHF/UHF COMMUNICATIONS
from 1 MHz to 400 MHz

P_D	Power Dissipation	875W (438W -A Version)
BV_{DSS}	Drain – Source Breakdown Voltage *	70V
BV_{GSS}	Gate – Source Breakdown Voltage*	±20V
$I_{D(sat)}$	Drain Current*	30A
T_{stg}	Storage Temperature	-65 to 150°C
T_j	Maximum Operating Junction Temperature	200°C

* Per Side

Semelab Plc reserves the right to change test conditions, parameter limits and package dimensions without notice. Information furnished by Semelab is believed to be both accurate and reliable at the time of going to press. However Semelab assumes no responsibility for any errors or omissions discovered in its use. Semelab encourages customers to verify that datasheets are current before placing orders.

ELECTRICAL CHARACTERISTICS (T_{case} = 25°C unless otherwise stated)

Parameter	Test Conditions	Min.	Typ.	Max.	Unit
PER SIDE					
B _V DSS	Drain–Source Breakdown Voltage	V _{GS} = 0	I _D = 100mA	70	V
I _{DSS}	Zero Gate Voltage Drain Current	V _{DS} = 28V	V _{GS} = 0		6 mA
I _{GSS}	Gate Leakage Current	V _{GS} = 20V	V _{DS} = 0		1 μA
V _{GS(th)}	Gate Threshold Voltage*	I _D = 10mA	V _{DS} = V _{GS}	1	7 V
g _{fs}	Forward Transconductance*	V _{DS} = 10V	I _D = 6A	4.8	mhos
V _{GS(th)match}	Gate Threshold Voltage Matching Between Sides	I _D = 10mA	V _{DS} = V _{GS}		0.1 V
TOTAL DEVICE					
G _{PS}	Common Source Power Gain	P _O = 300W		16	dB
η	Drain Efficiency	V _{DS} = 28V	I _{DQ} = 2A	60	%
VSWR	Load Mismatch Tolerance	f = 175MHz		20:1	—
PER SIDE					
C _{iss}	Input Capacitance	V _{DS} = 28V	V _{GS} = -5V f = 1MHz		360 pF
C _{oss}	Output Capacitance	V _{DS} = 28V	V _{GS} = 0 f = 1MHz		180 pF
C _{rss}	Reverse Transfer Capacitance	V _{DS} = 28V	V _{GS} = 0 f = 1MHz		15 pF

* Pulse Test: Pulse Duration = 300 μs , Duty Cycle ≤ 2%

THERMAL DATA

R _{THj-case}	Thermal Resistance Junction – Case	Max. 0.2°C / W 0.4 °C / W -A Version
-----------------------	------------------------------------	---

Semelab Plc reserves the right to change test conditions, parameter limits and package dimensions without notice. Information furnished by Semelab is believed to be both accurate and reliable at the time of going to press. However Semelab assumes no responsibility for any errors or omissions discovered in its use. Semelab encourages customers to verify that datasheets are current before placing orders.

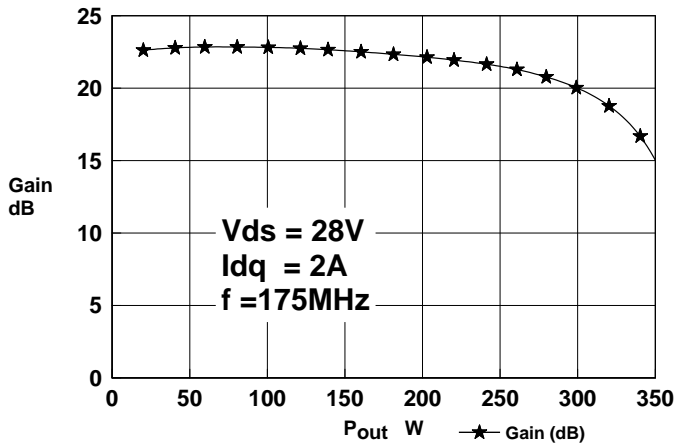

Figure 1 – Gain vs. Power Output.

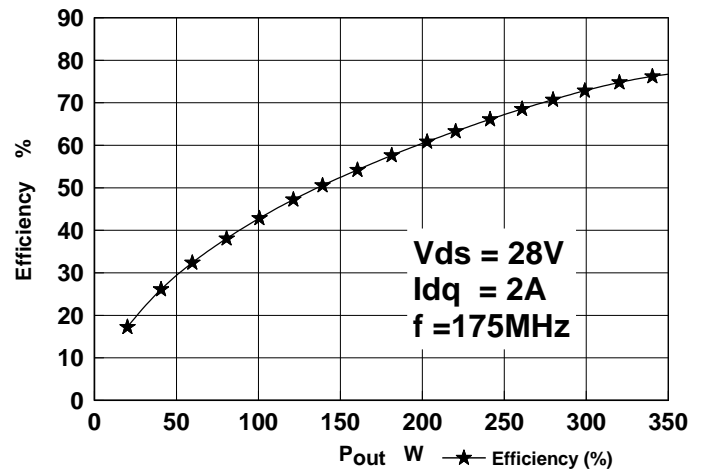

Figure 2 – Efficiency vs. Power Output.

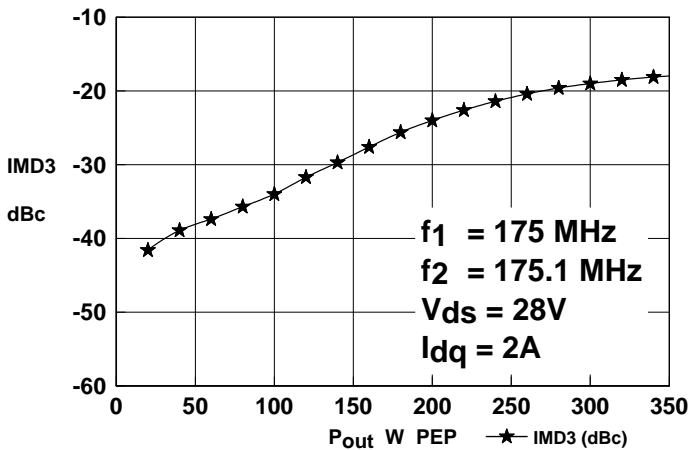

Figure 3 – IMD vs. Power Output

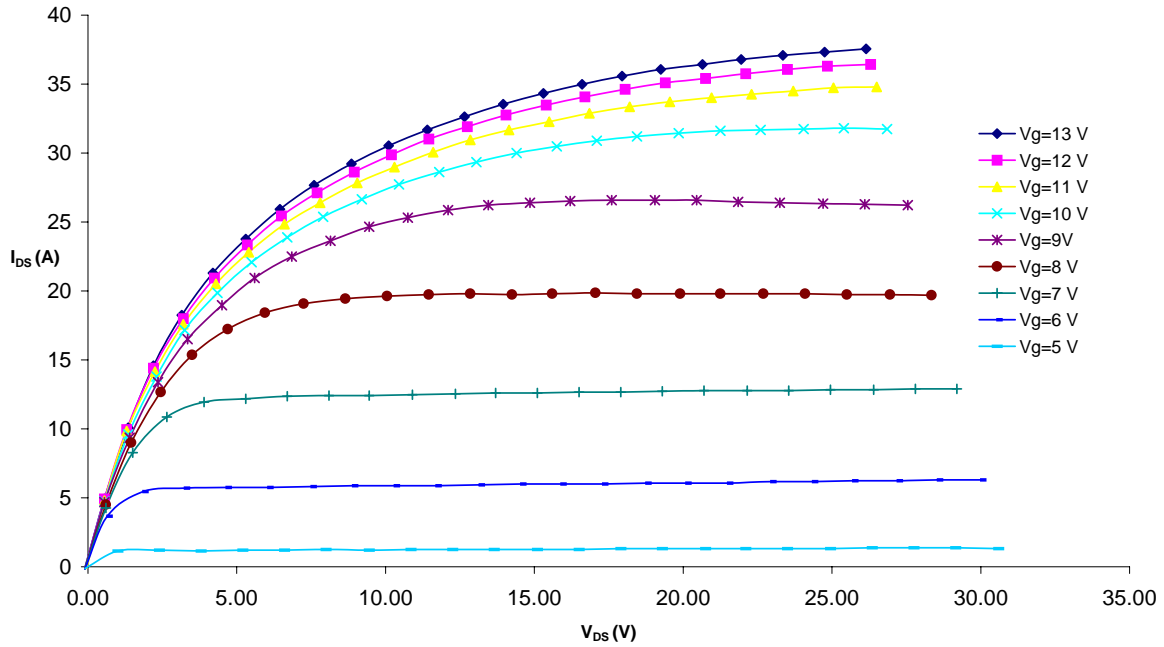

Figure 4 – Typical IV Characteristics.

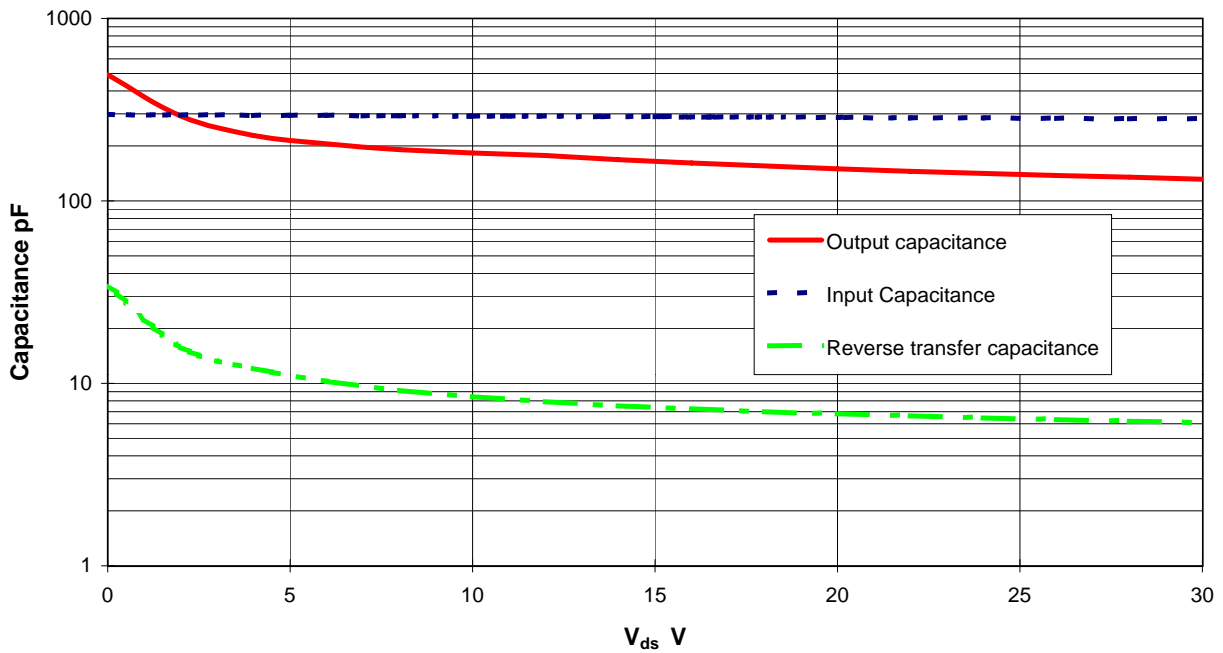
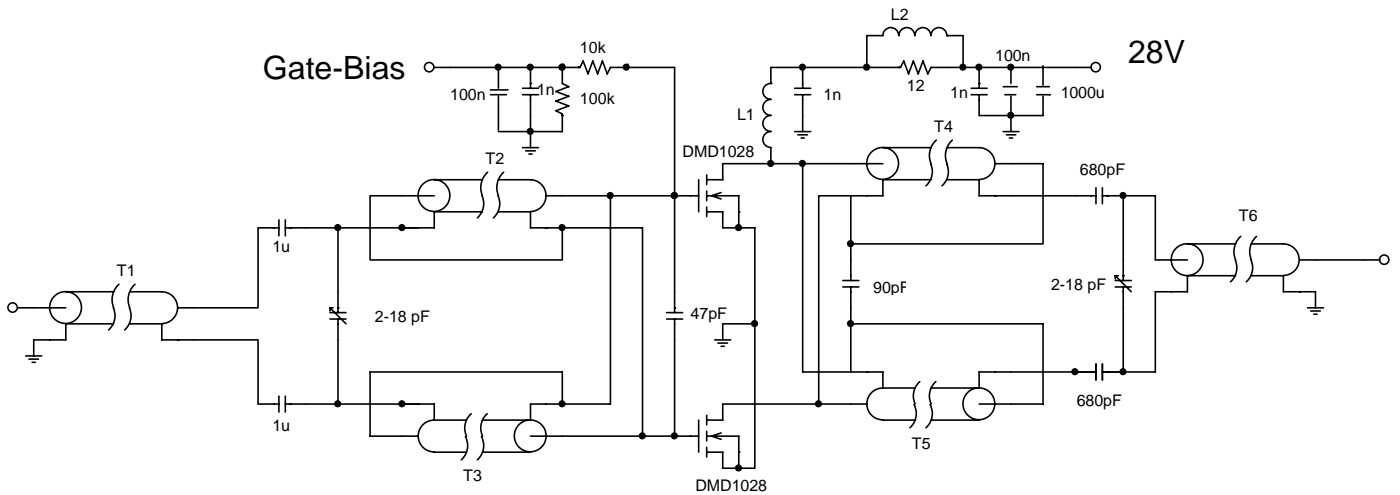

Figure 5 – Typical CV Characteristics.

Semelab Plc reserves the right to change test conditions, parameter limits and package dimensions without notice. Information furnished by Semelab is believed to be both accurate and reliable at the time of going to press. However Semelab assumes no responsibility for any errors or omissions discovered in its use. Semelab encourages customers to verify that datasheets are current before placing orders.



DMD1028 175MHz TEST FIXTURE

Substrate 1.6mm PTFE/glass, Er=2.5
All microstrip lines W=4.4mm

- T1,2,3 7cm Storm Products EXE18 19/30 S1TW coaxial cable on Siemens B62152A1X1 2-hole core.
- T4,5 14cm Storm Products EXE18 19/30 S1TW coaxial cable.
- T6 11cm Storm Products EXE18 19/30 S1TW coaxial cable
- L1 6 turns 1.2mm dia wire, 5mm internal diameter
- L2 1.5 turns 0.9mm dia wire on Siemens A1 x 1 2 hole core