

MECHANICAL DATA

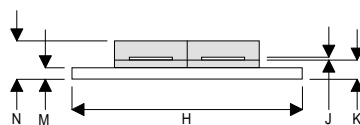
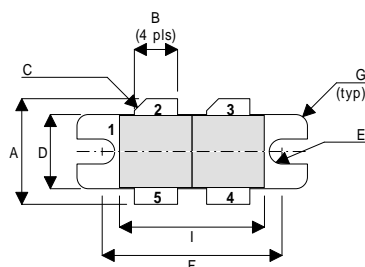

DH

PIN 1 SOURCE (COMMON) PIN 2 DRAIN 1
 PIN 3 DRAIN 2 PIN 4 GATE 2
 PIN 5 GATE 1

DIM	mm	Tol.	Inches	Tol.
A	13.97	0.26	0.550	0.010
B	5.72	0.13	0.225	0.005
C	45°	5°	45°	5°
D	9.78	0.13	0.385	0.005
E	1.65R	0.13	0.065R	0.005
F	23.75	0.13	0.935	0.005
G	1.52R	0.13	0.060R	0.005
H	30.48	0.13	1.200	0.005
I	19.17	0.26	0.755	0.010
J	0.13	0.02	0.005	0.001
K	2.54	0.13	0.100	0.005
M	1.52	0.13	0.060	0.005
N	5.08	0.50	0.200	0.020

**GOLD METALLISED
 MULTI-PURPOSE SILICON
 DMOS RF FET
 100W – 28V – 500MHz
 PUSH-PULL**

FEATURES

- SIMPLIFIED AMPLIFIER DESIGN
- SUITABLE FOR BROAD BAND APPLICATIONS
- LOW C_{rss}
- SIMPLE BIAS CIRCUITS
- LOW NOISE
- HIGH GAIN – 10 dB MINIMUM

APPLICATIONS

- HF/VHF/UHF COMMUNICATIONS
 from 1 MHz to 500 MHz

ABSOLUTE MAXIMUM RATINGS ($T_{case} = 25^\circ C$ unless otherwise stated)

P_D	Power Dissipation	290W
BV_{DSS}	Drain – Source Breakdown Voltage *	70V
BV_{GSS}	Gate – Source Breakdown Voltage *	$\pm 20V$
$I_{D(sat)}$	Drain Current *	15A
T_{stg}	Storage Temperature	-65 to 150°C
T_j	Maximum Operating Junction Temperature	200°C

* Per Side

Semelab Plc reserves the right to change test conditions, parameter limits and package dimensions without notice. Information furnished by Semelab is believed to be both accurate and reliable at the time of going to press. However Semelab assumes no responsibility for any errors or omissions discovered in its use. Semelab encourages customers to verify that datasheets are current before placing orders.

ELECTRICAL CHARACTERISTICS (T_{case} = 25° C unless otherwise stated)

Parameter	Test Conditions	Min.	Typ.	Max.	Unit	
PER SIDE						
B _V DSS	Drain–Source Breakdown Voltage	V _{GS} = 0	I _D = 100mA	70	V	
I _D DSS	Zero Gate Voltage Drain Current	V _{DS} = 28V	V _{GS} = 0	3	mA	
I _G DSS	Gate Leakage Current	V _{GS} = 20V	V _{DS} = 0	1	μA	
V _{GS(th)}	Gate Threshold Voltage*	I _D = 10mA	V _{DS} = V _{GS}	1	7	V
g _{fs}	Forward Transconductance*	V _{DS} = 10V	I _D = 3A	2.4	S	
TOTAL DEVICE						
G _{PS}	Common Source Power Gain	P _O = 100W		10	dB	
η	Drain Efficiency	V _{DS} = 28V	I _{DQ} = 1.2A	50	%	
VSWR	Load Mismatch Tolerance	f = 500MHz		20:1	—	
PER SIDE						
C _i SS	Input Capacitance	V _{DS} = 28V	V _{GS} = -5V f = 1MHz		180	pF
C _o SS	Output Capacitance	V _{DS} = 28V	V _{GS} = 0 f = 1MHz		90	pF
C _r SS	Reverse Transfer Capacitance	V _{DS} = 28V	V _{GS} = 0 f = 1MHz		7.5	pF

* Pulse Test: Pulse Duration = 300 μs , Duty Cycle ≤ 2%

HAZARDOUS MATERIAL WARNING

The ceramic portion of the device between leads and metal flange is beryllium oxide. Beryllium oxide dust is highly toxic and care must be taken during handling and mounting to avoid damage to this area.

THESE DEVICES MUST NEVER BE THROWN AWAY WITH GENERAL INDUSTRIAL OR DOMESTIC WASTE.

THERMAL DATA

R _{THj-case}	Thermal Resistance Junction – Case	Max. 0.6° C / W
-----------------------	------------------------------------	-----------------

Semelab Plc reserves the right to change test conditions, parameter limits and package dimensions without notice. Information furnished by Semelab is believed to be both accurate and reliable at the time of going to press. However Semelab assumes no responsibility for any errors or omissions discovered in its use. Semelab encourages customers to verify that datasheets are current before placing orders.

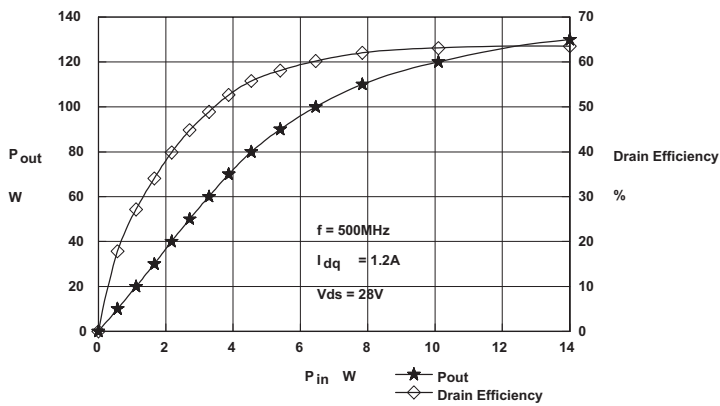

Figure 1 - Power Output and Efficiency vs. Power Input.

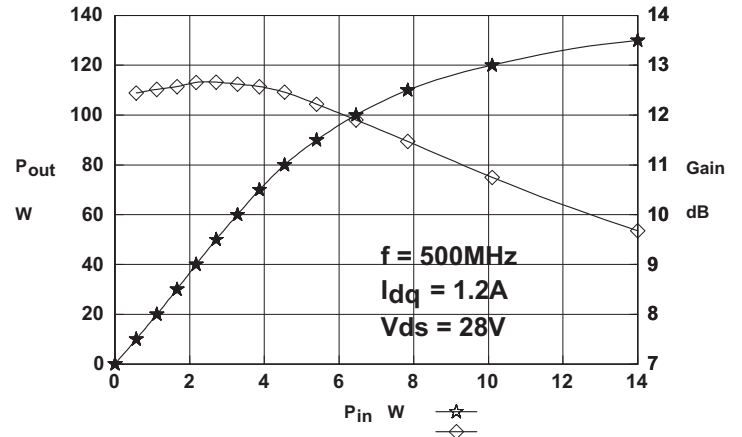

Figure 2 - Power Output & Gain vs. Power Input.

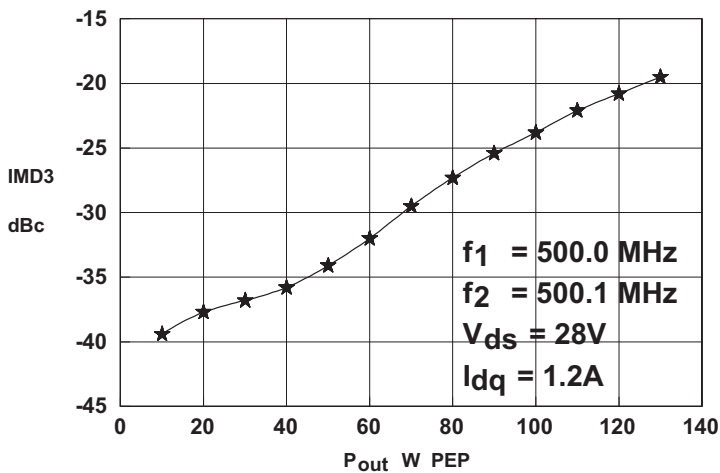

Figure 3 - IMD vs. Output Power.

D1012UK OPTIMUM SOURCE AND LOAD IMPEDANCE

Frequency MHz	Z _S Ω	Z _L Ω
500	2.0 - j2.2	2.6 - j0.6

N.B. Impedances measured terminal to terminal

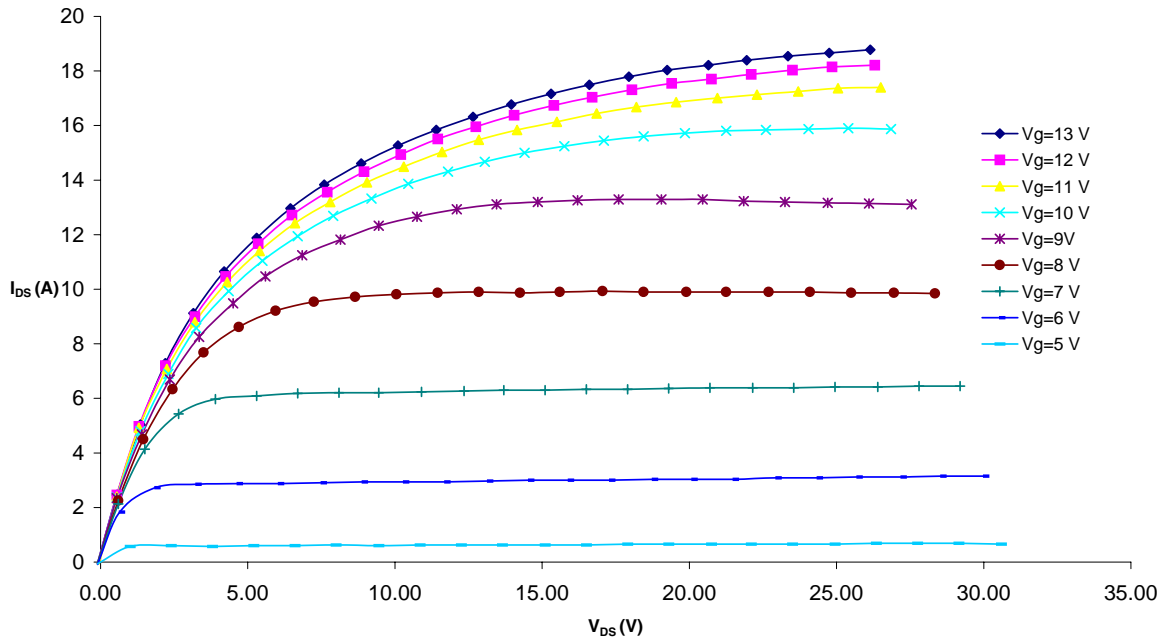

Figure 4 – Typical IV Characteristics.

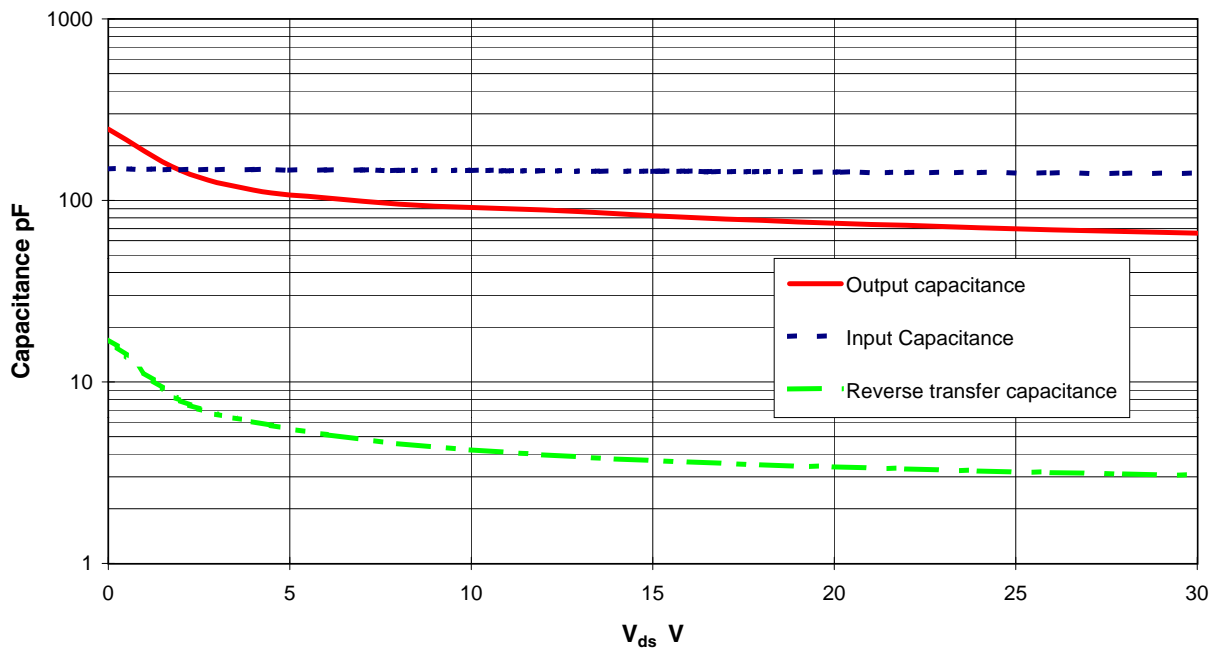
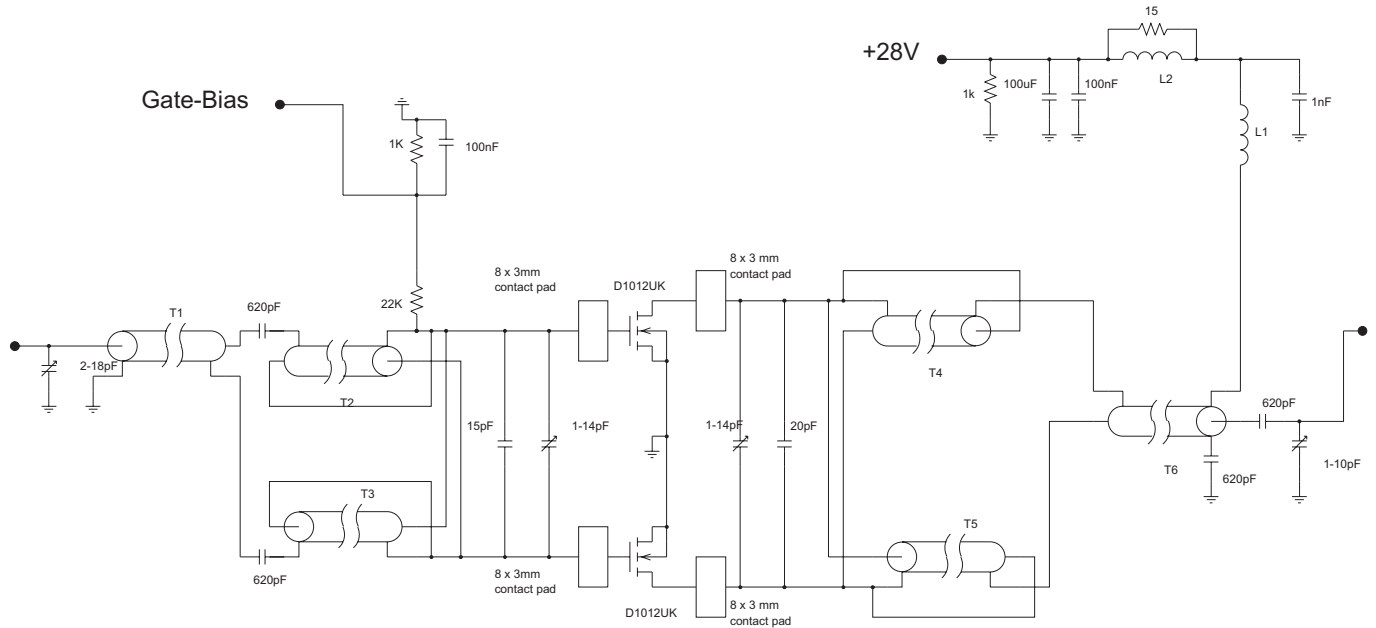

Figure 5 – Typical CV Characteristics.

Semelab Plc reserves the right to change test conditions, parameter limits and package dimensions without notice. Information furnished by Semelab is believed to be both accurate and reliable at the time of going to press. However Semelab assumes no responsibility for any errors or omissions discovered in its use. Semelab encourages customers to verify that datasheets are current before placing orders.



D1012UK 500MHz TEST FIXTURE

T1,6	65mm	50 Ohm UT85 semi-rigid coax
T2,3,4,5	75mm	15 Ohm UT85-15 semi-rigid coax
L1	6 turns	21 swg enamelled copper wire, 3mm i.d.
L2	8.5 turns	19 swg enamelled copper wire on Fair-Rite FT82-43 core

Semelab Plc reserves the right to change test conditions, parameter limits and package dimensions without notice. Information furnished by Semelab is believed to be both accurate and reliable at the time of going to press. However Semelab assumes no responsibility for any errors or omissions discovered in its use. Semelab encourages customers to verify that datasheets are current before placing orders.