

# SILICON PLANAR EPITAXIAL NPN TRANSISTOR

## 2N4238

- $V_{CBO}=80V(\text{Min}), V_{CEO}=60V(\text{Min})$
- Hermetic TO-39 Metal package.
- Ideally suited for General Purpose and Amplifier Applications
- Screening Options Available

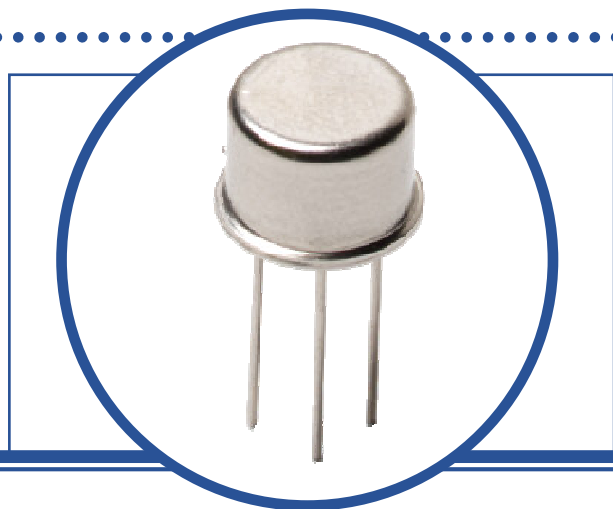

### ABSOLUTE MAXIMUM RATINGS ( $T_A = 25^\circ\text{C}$ unless otherwise stated)

$V_{CBO}$	Collector – Base Voltage		80V
$V_{CEO}$	Collector – Emitter Voltage		60V
$V_{EBO}$	Emitter – Base Voltage		6V
$I_C$	Continuous Collector Current		1.0A
$I_B$	Base Current		0.5A
$P_D$	Total Power Dissipation at	$T_A = 25^\circ\text{C}$	1.0W
		Derate Above $25^\circ\text{C}$	5.7mW/ $^\circ\text{C}$
$P_D$	Total Power Dissipation at	$T_C = 25^\circ\text{C}$	6W
		Derate Above $25^\circ\text{C}$	34mW/ $^\circ\text{C}$
$T_J$	Junction Temperature Range		-65 to +200 $^\circ\text{C}$
$T_{stg}$	Storage Temperature Range		-65 to +200 $^\circ\text{C}$

### THERMAL PROPERTIES

Symbols	Parameters	Min.	Typ.	Max.	Units
$R_{\theta JA}$	Thermal Resistance, Junction To Ambient			175	$^\circ\text{C/W}$
$R_{\theta JC}$	Thermal Resistance, Junction To Case			29	$^\circ\text{C/W}$

Semelab Limited reserves the right to change test conditions, parameter limits and package dimensions without notice. Information furnished by Semelab is believed to be both accurate and reliable at the time of going to press. However Semelab assumes no responsibility for any errors or omissions discovered in its use. Semelab encourages customers to verify that datasheets are current before placing orders.



# SILICON PLANAR EPITAXIAL NPN TRANSISTOR 2N4238

## ELECTRICAL CHARACTERISTICS ( $T_A = 25^\circ\text{C}$ unless otherwise stated)

Symbols	Parameters	Test Conditions	Min.	Typ	Max.	Units
$V_{(BR)CEO}^{(1)}$	Collector-Emitter Breakdown Voltage	$I_C = 10\text{mA}$ $I_B = 0$	60			V
$I_{CEX}$	Collector Cut-Off Current	$V_{CE} = 80\text{V}$ $V_{BE} = -1.5\text{V}$			100	nA
		$V_{CE} = 50\text{V}$ $V_{BE} = -1.5\text{V}$ $T_A = 150^\circ\text{C}$			25	$\mu\text{A}$
$I_{CBO}$	Collector Cut-Off Current	$V_{CB} = 80\text{V}$ $I_E = 0$			100	nA
$I_{EBO}$	Emitter Cut-Off Current	$V_{EB} = 6\text{V}$ $I_C = 0$			0.5	mA
$h_{FE}^{(1)}$	Forward-current transfer ratio	$I_C = 100\text{mA}$ $V_{CE} = 1.0\text{V}$	30			
		$I_C = 250\text{mA}$ $V_{CE} = 1.0\text{V}$	30		150	
		$T_A = -55^\circ\text{C}$	15			
$V_{CE(sat)}^{(1)}$	Collector-Emitter Saturation Voltage	$I_C = 500\text{mA}$ $I_B = 50\text{mA}$			0.3	V
		$I_C = 1.0\text{A}$ $I_B = 0.1\text{A}$			0.6	
$V_{BE(sat)}^{(1)}$	Base-Emitter Saturation Voltage	$I_C = 500\text{mA}$ $I_B = 50\text{mA}$			1.0	
		$I_C = 1.0\text{A}$ $I_B = 0.1\text{A}$			1.5	

## DYNAMIC CHARACTERISTICS

$ h_{fe} $	Small signal forward-current transfer ratio	$I_C = 100\text{mA}$ $V_{CE} = 10\text{V}$ $f = 10\text{MHz}$	3.0			
$C_{obo}$	Output Capacitance	$V_{CB} = 10\text{V}$ $I_E = 0$ $f = 1.0\text{MHz}$			100	pF

### Notes

(1) Pulse Width  $\leq 300\mu\text{s}$ ,  $\delta \leq 2\%$

# SILICON PLANAR EPITAXIAL NPN TRANSISTOR 2N4238

## MECHANICAL DATA

Dimensions in mm (inches)

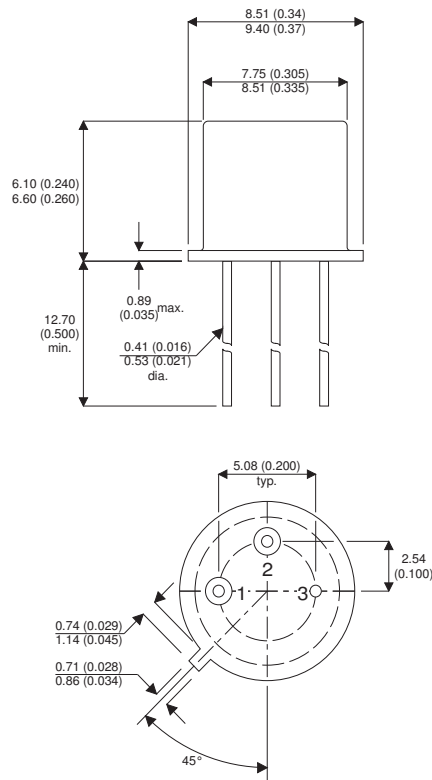

### TO-39 (TO-205AD) METAL PACKAGE Underside View

Pin 1 - Emitter

Pin 2 - Base

Pin 3 - Collector