

Dimensions in mm (inches).

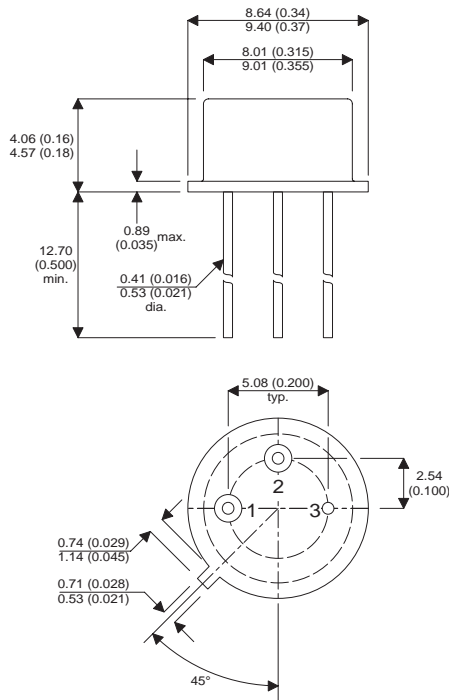

**TO39 (TO205AF)  
PINOUTS**

1 – Source    2 – Gate    3 - Drain

**N-Channel MOSFET  
in a  
Hermetically sealed TO39  
Metal Package.**

**N-Channel MOSFET.**

**$V_{DSS} = 100V$**

**$I_D = 4.5A$**

**$R_{DS(ON)} = 0.3\Omega$**

All Semelab hermetically sealed products can be processed in accordance with the requirements of BS, CECC and JAN, JANTX, JANTXV and JANS specifications.

	Parameter	Min.	Typ.	Max.	Units
$V_{DSS}$	Drain – Source Breakdown Voltage			100	V
$I_D$	Continuous Drain Current			4.5	A
$P_D$	Power Dissipation			20	W
$R_{DS(ON)}$	Static Drain – Source On–State Resistance			0.3	$\Omega$
$C_{ISS}$	Input Capacitance		350		pF
$Q_g$	Total Gate Charge			17	nC
$t_{td(on)}$	Turn–On Delay Time			40	ns
$t_{tr}$	Rise Time			70	ns
$t_{td(off)}$	Turn–Off Delay Time			40	ns
$t_f$	Fall Time			70	ns

This is a shortform datasheet. For a full datasheet please contact [sales@semelab.co.uk](mailto:sales@semelab.co.uk).

Semelab Plc reserves the right to change test conditions, parameter limits and package dimensions without notice. Information furnished by Semelab is believed to be both accurate and reliable at the time of going to press. However Semelab assumes no responsibility for any errors or omissions discovered in its use.