

# Frequency Synthesizer

KSN-1970A-219+

50Ω 1849.6 to 1969.92 MHz

## The Big Deal

- Low phase noise and spurious
- Robust design and construction
- Small size 0.80" x 0.58" x 0.15"



CASE STYLE: DK1042

## Product Overview

The KSN-1970A-219+ is a Frequency Synthesizer, designed to operate from 1849.6 to 1969.92 MHz for TD-SCDMA application. The KSN-1970A-219+ is packaged in a metal case (size of 0.80" x 0.58" x 0.15") to shield against unwanted signals and noise.

## Key Features

Feature	Advantages
Low phase noise and spurious: <ul style="list-style-type: none"><li>• Phase Noise: -93 dBc/Hz typ. @ 10 kHz offset</li><li>• Comparison Spurious: -107 dBc typ.</li><li>• Reference Spurious: -103 dBc typ.</li></ul>	Low phase noise and spurious improve system EVM (Error Vector Magnitude).
Robust design and construction	To enhance the robustness of KSN-1970A-219+, each internal component is secured to the substrate with chip bonder, thereby eliminating the risk of tombstoning during subsequent solder reflow operations by the customer.
Small size, 0.80" x 0.58" x 0.15"	The small size enables the KSN-1970A-219+ to be used in compact designs.



IF/RF MICROWAVE COMPONENTS • ISO 9001 ISO 14001 AS 9100 CERTIFIED RoHS compliant  
P.O. Box 350166, Brooklyn, New York 11235-0003 (718) 934-4500 Fax (718) 332-4661



The Design Engineers Search Engine finds the model you need, Instantly • For detailed performance specs & shopping online see



Notes: 1. Performance and quality attributes and conditions not expressly stated in this specification sheet are intended to be excluded and do not form a part of this specification sheet. 2. Electrical specifications and performance data contained herein are based on Mini-Circuit's applicable established test performance criteria and measurement instructions. 3. The parts covered by this specification sheet are subject to Mini-Circuits standard limited warranty and terms and conditions (collectively, "Standard Terms"); Purchasers of this part are entitled to the rights and benefits contained therein. For a full statement of the Standard Terms and the exclusive rights and remedies thereunder, please visit Mini-Circuits' website at [www.minicircuits.com/MCLStore/terms.jsp](http://www.minicircuits.com/MCLStore/terms.jsp).

# Frequency Synthesizer

KSN-1970A-219+

50Ω 1849.6 to 1969.92 MHz

## Features

- Integrated VCO + PLL
- Low phase noise and spurious
- Robust design and construction
- Low operating voltage (VCC VCO=+5V, VCC PLL=+5V)
- Small size 0.80" x 0.58" x 0.15"



CASE STYLE: DK1042  
PRICE: \$29.95 ea. QTY (1-9)

+ RoHS compliant in accordance with EU Directive (2002/95/EC)

The +Suffix has been added in order to identify RoHS Compliance. See our web site for RoHS Compliance methodologies and qualifications.

## Applications

- TD-SCDMA

## General Description

The KSN-1970A-219+ is a Frequency Synthesizer, designed to operate from 1849.6 to 1969.92 MHz for TD-SCDMA application. The KSN-1970A-219+ is packaged in a metal case (size of 0.80" x 0.58" x 0.15") to shield against unwanted signals and noise. To enhance the robustness of KSN-1970A-219+, each internal component is secured to the substrate with chip bonder, thereby eliminating the risk of tombstoning during subsequent solder reflow operations by the customer.

## Simplified Schematic



IF/RF MICROWAVE COMPONENTS • ISO 9001 ISO 14001 AS 9100 CERTIFIED RoHS compliant  
P.O. Box 350166, Brooklyn, New York 11235-0003 (718) 934-4500 Fax (718) 332-4661



The Design Engineers Search Engine finds the model you need, Instantly • For detailed performance specs & shopping online see [minicircuits.com](http://minicircuits.com)

Notes: 1. Performance and quality attributes and conditions not expressly stated in this specification sheet are intended to be excluded and do not form a part of this specification sheet. 2. Electrical specifications and performance data contained herein are based on Mini-Circuit's applicable established test performance criteria and measurement instructions. 3. The parts covered by this specification sheet are subject to Mini-Circuits standard limited warranty and terms and conditions (collectively, "Standard Terms"); Purchasers of this part are entitled to the rights and benefits contained therein. For a full statement of the Standard Terms and the exclusive rights and remedies thereunder, please visit Mini-Circuits' website at [www.minicircuits.com/MCLStore/terms.jsp](http://www.minicircuits.com/MCLStore/terms.jsp).



**Electrical Specifications** (over operating temperature -40°C to +85°C)

Parameters	Test Conditions	Min.	Typ.	Max.	Units
Frequency Range	-	1849.6	-	1969.92	MHz
Step Size	-	-	1280	-	kHz
Settling Time	Within ± 1 kHz	-	5	-	mSec
Output Power	-	+2	+5	+7	dBm
SSB Phase Noise	@ 100 Hz offset	-	-79	-	dBc/Hz
	@ 1 kHz offset	-	-88	-79	
	@ 10 kHz offset	-	-93	-89	
	@ 100 kHz offset	-	-124	-120	
	@ 1 MHz offset	-	-146	-142	
Integrated SSB Phase Noise	@ 1 kHz to 5 MHz	-	-47	-41	dBc
Reference Spurious Suppression	Ref. Freq. 76.8 MHz	-	-103	-85	dBc
Comparison Spurious Suppression	Step Size 1280 kHz	-	-107	-85	
Non - Harmonic Spurious Suppression	-	-	-90	-	
Harmonic Suppression	-	-	-46	-25	
VCO Supply Voltage	5.00	4.75	5.00	5.25	V
PLL Supply Voltage	5.00	4.75	5.00	5.25	
VCO Supply Current	-	-	27	33	mA
PLL Supply Current	-	-	14	22	
Reference Input (External)	Frequency	76.8 (sine wave)	-	76.8	MHz
	Amplitude	1	-	1	V <sub>P-P</sub>
	Input impedance	-	-	100	KΩ
	Phase Noise @ 1 kHz offset	-	-	-130	dBc/Hz
RF Output port Impedance	-	-	50	-	Ω
Input Logic Level	Input high voltage	-	4.20	-	V
	Input low voltage	-	-	0.95	V
Digital Lock Detect	Locked	-	4.35	5.25	V
	Unlocked	-	-	0.40	V
Frequency Synthesizer PLL	-	ADF4113			
PLL Programming	-	3-wire serial 5V CMOS			
Register Map @ 1969.92MHz	F_Register	-	(MSB) 100111111000000010010010 (LSB)		
	N_Register	-	(MSB) 001000000011000000001101 (LSB)		
	R_Register	-	(MSB) 00010000000000001110000 (LSB)		

**Absolute Maximum Ratings**

Parameters	Ratings
VCO Supply Voltage	6V
PLL Supply Voltage	6V
VCO Supply Voltage to PLL Supply Voltage	N.A
Reference Frequency Voltage	-0.3Vmin,VCC PLL +0.3Vmax
Data, Clock, LE Levels	-0.3Vmin,VCC PLL +0.3Vmax
Operating Temperature	-40°C to +85°C
Storage Temperature	-55°C to +100°C

Permanent damage may occur if any of these limits are exceeded



IF/RF MICROWAVE COMPONENTS • ISO 9001 ISO 14001 AS9100 CERTIFIED RoHS compliant

P.O. Box 350166, Brooklyn, New York 11235-0003 (718) 934-4500 Fax (718) 332-4661



The Design Engineers Search Engine finds the model you need, Instantly • For detailed performance specs & shopping online see [minicircuits.com](http://minicircuits.com)

Notes: 1. Performance and quality attributes and conditions not expressly stated in this specification sheet are intended to be excluded and do not form a part of this specification sheet. 2. Electrical specifications and performance data contained herein are based on Mini-Circuit's applicable established test performance criteria and measurement instructions. 3. The parts covered by this specification sheet are subject to Mini-Circuits standard limited warranty and terms and conditions (collectively, "Standard Terms"); Purchasers of this part are entitled to the rights and benefits contained therein. For a full statement of the Standard Terms and the exclusive rights and remedies thereunder, please visit Mini-Circuits' website at [www.minicircuits.com/MCLStore/terms.jsp](http://www.minicircuits.com/MCLStore/terms.jsp).

Typical Performance Data

FREQUENCY (MHz)	POWER OUTPUT (dBm)			VCO CURRENT (mA)			PLL CURENT (mA)		
	-45°C	+25°C	+85°C	-45°C	+25°C	+85°C	-45°C	+25°C	+85°C
	1849.60	5.01	5.02	5.05	26.17	27.19	27.99	11.30	13.42
1861.12	5.03	5.03	5.04	26.14	27.16	27.97	11.41	13.55	15.44
1876.48	5.10	5.08	5.07	26.09	27.12	27.94	11.56	13.71	15.62
1891.84	5.15	5.14	5.11	26.06	27.09	27.92	11.33	13.48	15.39
1907.20	5.16	5.14	5.12	26.06	27.08	27.91	11.49	13.64	15.56
1922.56	5.16	5.11	5.08	26.01	27.03	27.88	11.63	13.80	15.72
1937.92	5.20	5.11	5.05	25.93	27.00	27.82	11.40	13.56	15.48
1953.28	5.24	5.13	5.04	25.87	26.92	27.79	11.55	13.72	15.65
1968.64	5.27	5.14	5.03	25.84	26.89	27.76	11.32	13.48	15.41
1969.92	5.28	5.13	5.03	25.83	26.92	27.76	11.33	13.49	15.43

FREQUENCY (MHz)	HARMONICS (dBc)					
	F2			F3		
	-45°C	+25°C	+85°C	-45°C	+25°C	+85°C
1849.60	-60.99	-62.76	-64.23	-51.20	-52.12	-54.29
1861.12	-63.11	-65.65	-65.25	-50.83	-52.35	-53.21
1876.48	-60.89	-65.54	-66.58	-48.95	-50.56	-51.74
1891.84	-57.39	-64.23	-66.27	-47.17	-48.19	-50.16
1907.20	-59.64	-67.87	-64.26	-45.06	-49.60	-47.65
1922.56	-57.23	-70.87	-62.65	-44.95	-46.69	-48.60
1937.92	-53.38	-64.28	-62.85	-43.79	-45.75	-46.90
1953.28	-53.03	-67.23	-60.74	-43.94	-46.94	-47.06
1968.64	-55.60	-68.09	-57.89	-43.53	-45.26	-46.03
1969.92	-55.36	-68.20	-58.37	-43.52	-45.43	-45.97



IF/RF MICROWAVE COMPONENTS • ISO 9001 ISO 14001 AS9100 CERTIFIED RoHS compliant  
 P.O. Box 350166, Brooklyn, New York 11235-0003 (718) 934-4500 Fax (718) 332-4661



The Design Engineers Search Engine finds the model you need, Instantly • For detailed performance specs & shopping online see



Notes: 1. Performance and quality attributes and conditions not expressly stated in this specification sheet are intended to be excluded and do not form a part of this specification sheet. 2. Electrical specifications and performance data contained herein are based on Mini-Circuit's applicable established test performance criteria and measurement instructions. 3. The parts covered by this specification sheet are subject to Mini-Circuits standard limited warranty and terms and conditions (collectively, "Standard Terms"); Purchasers of this part are entitled to the rights and benefits contained therein. For a full statement of the Standard Terms and the exclusive rights and remedies thereunder, please visit Mini-Circuits' website at [www.minicircuits.com/MCLStore/terms.jsp](http://www.minicircuits.com/MCLStore/terms.jsp).

FREQUENCY (MHz)	PHASE NOISE (dBc/Hz) @ OFFSETS				
	+25°C				
	100Hz	1kHz	10kHz	100kHz	1MHz
1849.60	-78.82	-88.00	-95.08	-125.33	-146.30
1861.12	-78.49	-89.63	-94.44	-125.12	-146.56
1876.48	-80.19	-90.49	-93.30	-125.05	-146.55
1891.84	-78.48	-88.22	-92.58	-124.77	-146.40
1907.20	-79.22	-88.17	-92.73	-124.78	-146.36
1922.56	-78.20	-90.51	-92.80	-124.48	-146.28
1937.92	-81.47	-87.30	-92.60	-124.09	-145.47
1953.28	-80.76	-88.25	-92.83	-123.61	-145.06
1968.64	-78.62	-88.46	-93.50	-123.64	-145.41
1969.92	-77.59	-87.12	-93.15	-123.49	-145.13

FREQUENCY (MHz)	PHASE NOISE (dBc/Hz) @ OFFSETS				
	-45°C				
	100Hz	1kHz	10kHz	100kHz	1MHz
1849.60	-81.69	-89.49	-95.12	-125.75	-147.35
1861.12	-79.98	-88.90	-94.40	-125.57	-147.01
1876.48	-79.78	-88.53	-93.96	-125.28	-146.93
1891.84	-79.07	-89.06	-92.70	-125.08	-147.00
1907.20	-80.01	-89.60	-92.62	-124.91	-146.78
1922.56	-78.57	-88.42	-92.67	-124.53	-146.63
1937.92	-78.79	-89.73	-92.37	-123.91	-146.32
1953.28	-80.80	-86.53	-93.04	-123.63	-145.56
1968.64	-79.46	-88.19	-93.04	-123.33	-145.24
1969.92	-79.33	-86.47	-93.01	-123.23	-145.38

FREQUENCY (MHz)	PHASE NOISE (dBc/Hz) @ OFFSETS				
	+85°C				
	100Hz	1kHz	10kHz	100kHz	1MHz
1849.60	-77.78	-87.66	-94.18	-124.52	-145.59
1861.12	-81.01	-87.93	-93.16	-124.42	-145.89
1876.48	-77.85	-87.87	-92.28	-124.13	-145.59
1891.84	-78.90	-86.10	-91.68	-124.13	-145.64
1907.20	-78.10	-86.38	-92.11	-124.03	-145.70
1922.56	-78.40	-85.74	-91.96	-123.99	-145.63
1937.92	-79.64	-83.98	-91.88	-123.46	-145.29
1953.28	-77.24	-86.12	-92.08	-123.38	-145.08
1968.64	-76.93	-83.29	-92.45	-123.45	-144.86
1969.92	-78.34	-85.61	-92.15	-123.24	-144.91



IF/RF MICROWAVE COMPONENTS • ISO 9001 ISO 14001 AS9100 CERTIFIED RoHS compliant

P.O. Box 350166, Brooklyn, New York 11235-0003 (718) 934-4500 Fax (718) 332-4661



The Design Engineers Search Engine finds the model you need, Instantly • For detailed performance specs & shopping online see [minicircuits.com](http://minicircuits.com)

Notes: 1. Performance and quality attributes and conditions not expressly stated in this specification sheet are intended to be excluded and do not form a part of this specification sheet. 2. Electrical specifications and performance data contained herein are based on Mini-Circuit's applicable established test performance criteria and measurement instructions. 3. The parts covered by this specification sheet are subject to Mini-Circuits standard limited warranty and terms and conditions (collectively, "Standard Terms"); Purchasers of this part are entitled to the rights and benefits contained therein. For a full statement of the Standard Terms and the exclusive rights and remedies thereunder, please visit Mini-Circuits' website at [www.minicircuits.com/MCLStore/terms.jsp](http://www.minicircuits.com/MCLStore/terms.jsp).

COMPARISON SPURIOUS ORDER	COMPARISON SPURIOUS @Fcarrier 1849.6MHz+(n*Fcomparison) (dBc) note 1			COMPARISON SPURIOUS @Fcarrier 1909.76MHz+(n*Fcomparison) (dBc) note 1			COMPARISON SPURIOUS @Fcarrier 1969.92MHz+(n*Fcomparison) (dBc) note 1			
	n	-45°C	+25°C	+85°C	-45°C	+25°C	+85°C	-45°C	+25°C	+85°C
	-5	-102.05	-103.91	-108.38	-111.20	-118.98	-116.43	-119.98	-126.27	-114.85
-4	-116.05	-122.66	-127.03	-112.84	-113.52	-112.94	-121.19	-128.52	-113.45	
-3	-122.26	-116.60	-117.00	-109.08	-115.34	-113.63	-114.78	-123.21	-110.18	
-2	-121.42	-110.99	-111.34	-107.25	-104.31	-107.29	-115.78	-121.54	-108.55	
-1	-118.04	-107.43	-104.62	-95.29	-102.07	-98.39	-110.16	-112.62	-101.17	
0 <sup>note 2</sup>	-	-	-	-	-	-	-	-	-	
+1	-119.96	-108.73	-104.61	-95.30	-102.50	-96.85	-111.03	-108.31	-99.86	
+2	-119.87	-111.79	-109.36	-105.59	-102.27	-105.56	-116.89	-115.29	-107.82	
+3	-119.15	-117.64	-117.39	-107.15	-113.80	-111.96	-122.11	-112.30	-108.02	
+4	-117.98	-116.33	-118.79	-111.91	-110.03	-111.09	-125.63	-118.15	-113.39	
+5	-104.74	-111.15	-117.40	-111.89	-113.36	-114.20	-127.19	-119.85	-113.07	

Note 1: Comparison frequency 1280 kHz  
 Note 2: All spurs are referenced to carrier signal (n=0).

REFERENCE SPURIOUS ORDER	REFERENCE SPURIOUS @Fcarrier 1849.6MHz+(n*Reference) (dBc) note 3			REFERENCE SPURIOUS @Fcarrier 1909.76MHz+(n*Reference) (dBc) note 3			REFERENCE SPURIOUS @Fcarrier 1969.92MHz+(n*Reference) (dBc) note 3			
	n	-45°C	+25°C	+85°C	-45°C	+25°C	+85°C	-45°C	+25°C	+85°C
	-5	-116.94	-117.84	-120.73	-111.51	-115.61	-119.78	-112.02	-119.31	-119.36
-4	-104.35	-104.93	-107.75	-100.62	-105.37	-107.79	-98.26	-103.70	-104.20	
-3	-94.75	-97.51	-100.97	-102.50	-109.57	-107.84	-109.33	-112.78	-110.14	
-2	-97.27	-98.70	-99.06	-96.52	-98.08	-99.52	-97.13	-97.33	-98.07	
-1	-95.95	-101.47	-103.90	-96.20	-101.94	-105.80	-95.98	-100.40	-105.25	
0 <sup>note 4</sup>	-	-	-	-	-	-	-	-	-	
+1	-98.30	-103.83	-107.13	-99.74	-103.21	-108.10	-99.69	-105.62	-108.73	
+2	-96.93	-96.68	-98.25	-98.55	-98.40	-99.61	-98.20	-98.67	-100.04	
+3	-95.41	-97.93	-99.60	-102.26	-103.37	-107.86	-104.54	-105.02	-109.49	
+4	-97.65	-99.92	-102.04	-98.27	-102.23	-103.97	-97.68	-100.64	-98.24	
+5	-111.14	-112.69	-118.03	-110.29	-112.66	-115.49	-113.09	-111.77	-116.86	

Note 3: Reference frequency 76.8 MHz  
 Note 4: All spurs are referenced to carrier signal (n=0).



Typical Performance Curves

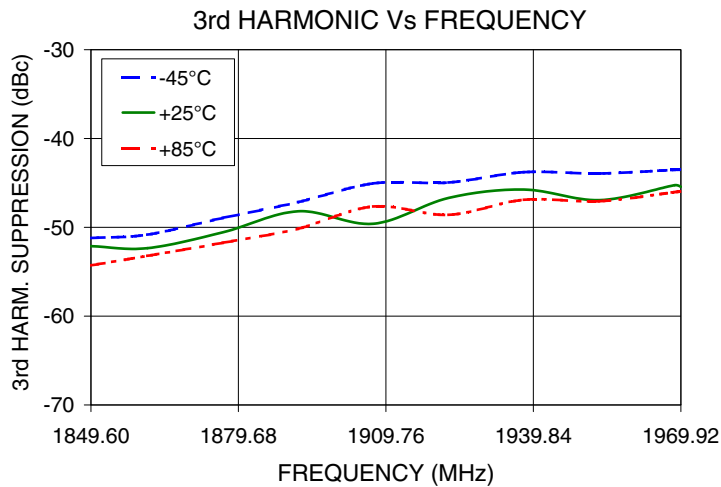
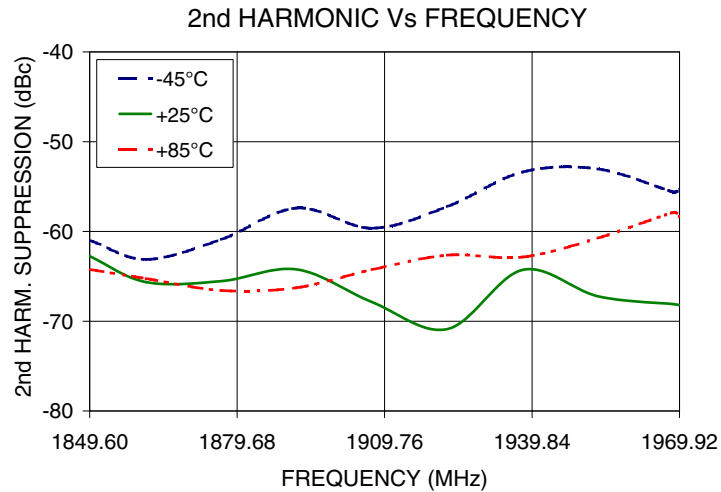
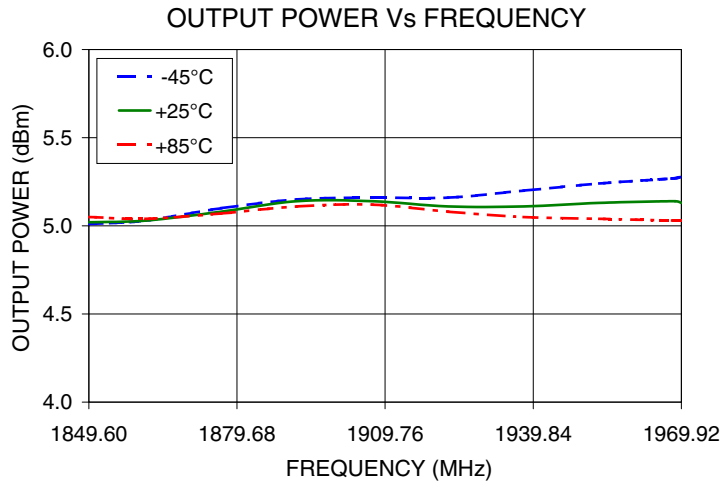

IF/RF MICROWAVE COMPONENTS • ISO 9001 ISO 14001 AS9100 CERTIFIED RoHS compliant  
 P.O. Box 350166, Brooklyn, New York 11235-0003 (718) 934-4500 Fax (718) 332-4661



The Design Engineers Search Engine finds the model you need, Instantly • For detailed performance specs & shopping online see



Notes: 1. Performance and quality attributes and conditions not expressly stated in this specification sheet are intended to be excluded and do not form a part of this specification sheet. 2. Electrical specifications and performance data contained herein are based on Mini-Circuit's applicable established test performance criteria and measurement instructions. 3. The parts covered by this specification sheet are subject to Mini-Circuits standard limited warranty and terms and conditions (collectively, "Standard Terms"); Purchasers of this part are entitled to the rights and benefits contained therein. For a full statement of the Standard Terms and the exclusive rights and remedies thereunder, please visit Mini-Circuits' website at [www.minicircuits.com/MCLStore/terms.jsp](http://www.minicircuits.com/MCLStore/terms.jsp).

PHASE NOISE @100Hz offset

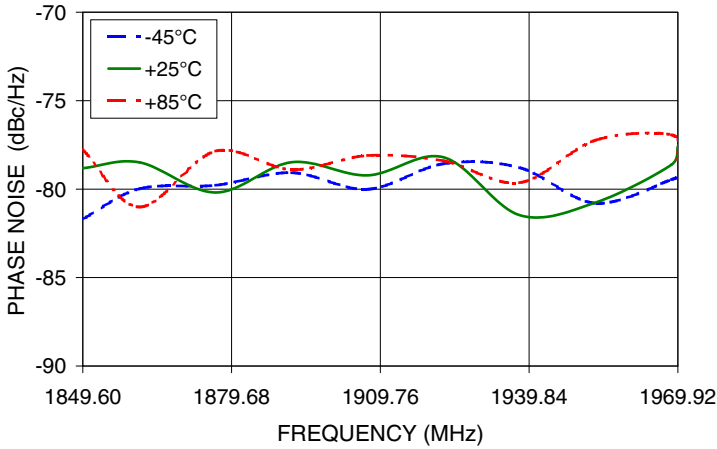

PHASE NOISE @1kHz offset

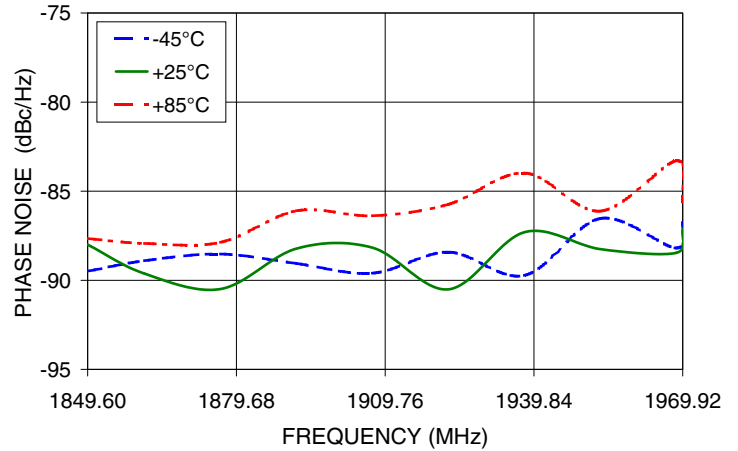

PHASE NOISE @ 10 kHz offset

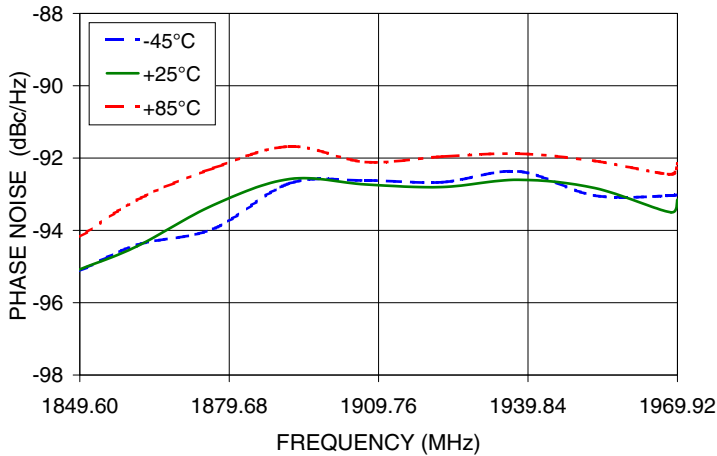

PHASE NOISE @ 100 kHz offset

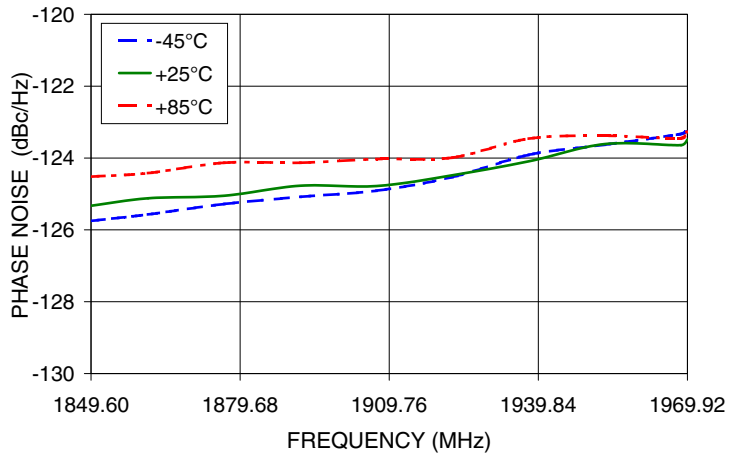

PHASE NOISE @ 1MHz offset

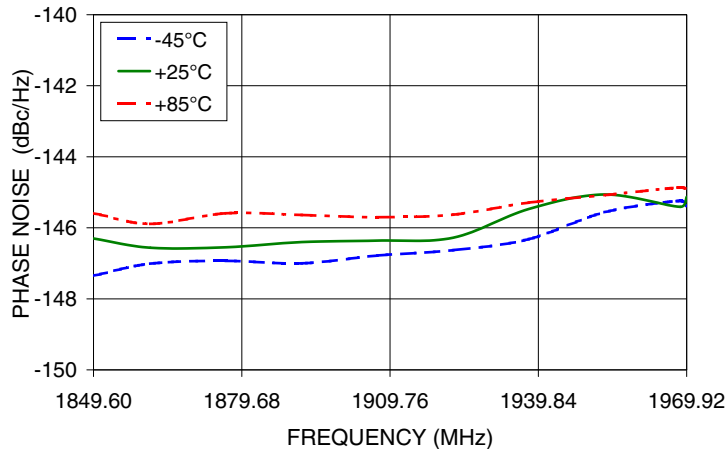

IF/RF MICROWAVE COMPONENTS • ISO 9001 ISO 14001 AS9100 CERTIFIED RoHS compliant  
 P.O. Box 350166, Brooklyn, New York 11235-0003 (718) 934-4500 Fax (718) 332-4661



The Design Engineers Search Engine finds the model you need, Instantly • For detailed performance specs & shopping online see



Notes: 1. Performance and quality attributes and conditions not expressly stated in this specification sheet are intended to be excluded and do not form a part of this specification sheet. 2. Electrical specifications and performance data contained herein are based on Mini-Circuit's applicable established test performance criteria and measurement instructions. 3. The parts covered by this specification sheet are subject to Mini-Circuits standard limited warranty and terms and conditions (collectively, "Standard Terms"); Purchasers of this part are entitled to the rights and benefits contained therein. For a full statement of the Standard Terms and the exclusive rights and remedies thereunder, please visit Mini-Circuits' website at [www.minicircuits.com/MCLStore/terms.jsp](http://www.minicircuits.com/MCLStore/terms.jsp).

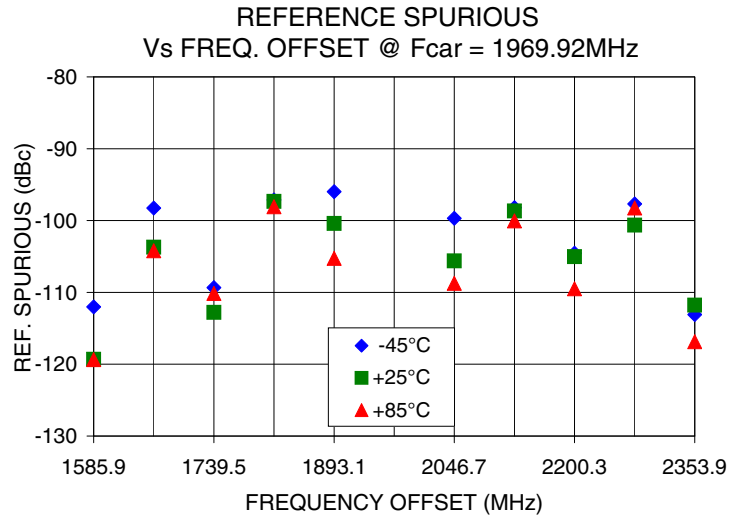
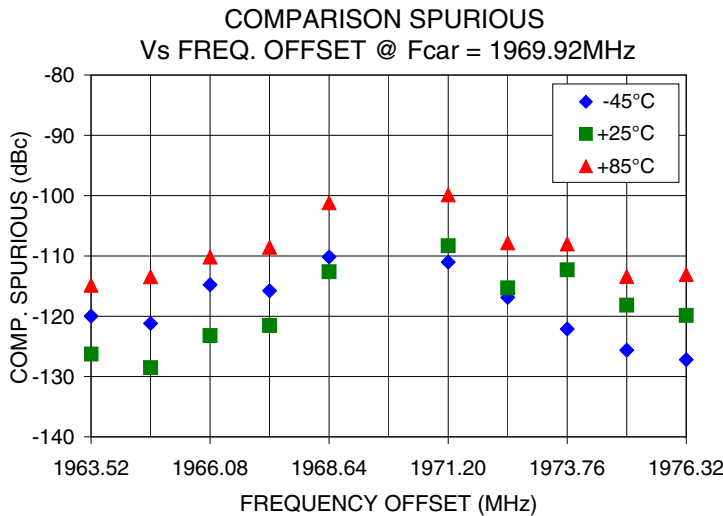
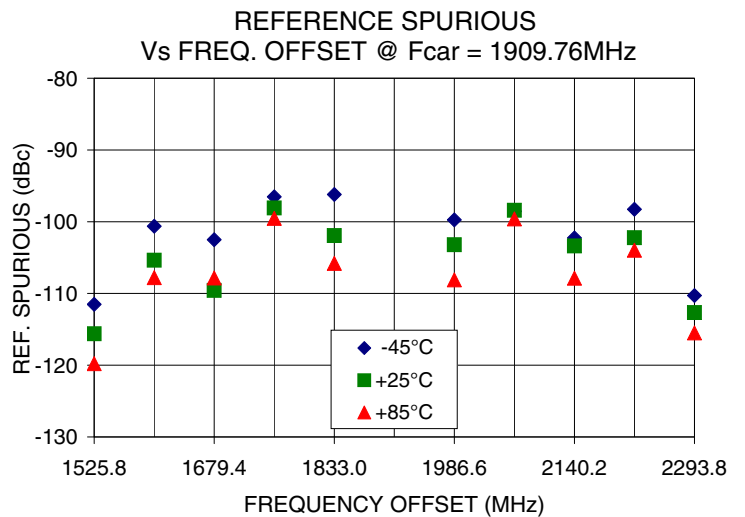
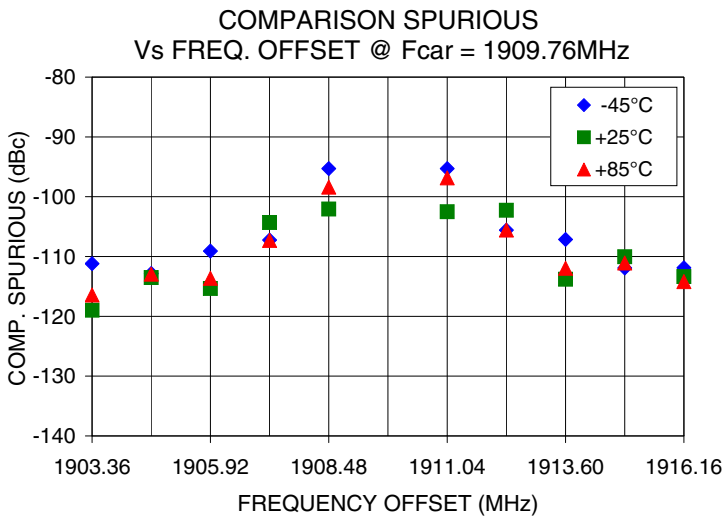
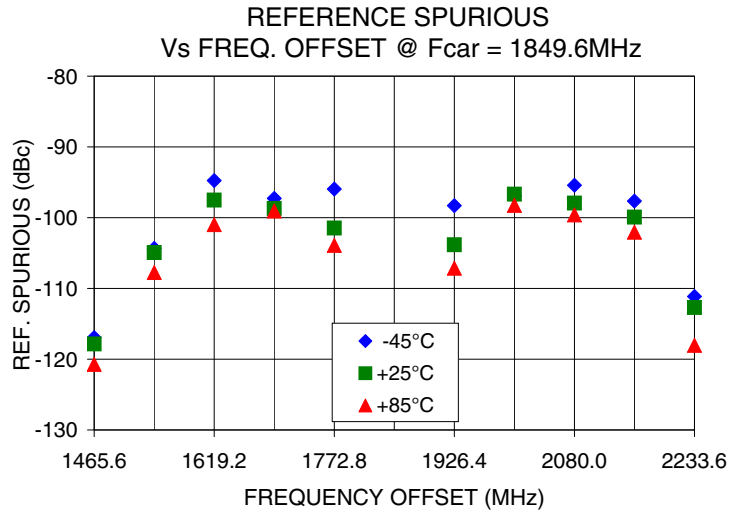
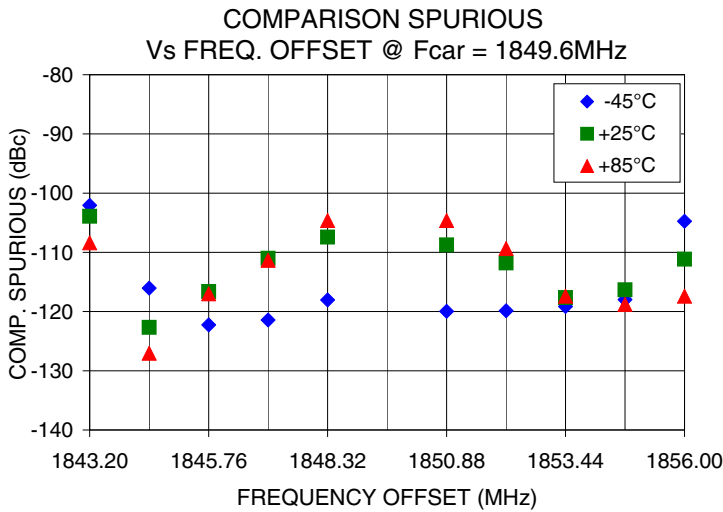

IF/RF MICROWAVE COMPONENTS • ISO 9001 ISO 14001 AS9100 CERTIFIED RoHS compliant

P.O. Box 350166, Brooklyn, New York 11235-0003 (718) 934-4500 Fax (718) 332-4661



The Design Engineers Search Engine finds the model you need, Instantly • For detailed performance specs & shopping online see



Notes: 1. Performance and quality attributes and conditions not expressly stated in this specification sheet are intended to be excluded and do not form a part of this specification sheet. 2. Electrical specifications and performance data contained herein are based on Mini-Circuit's applicable established test performance criteria and measurement instructions. 3. The parts covered by this specification sheet are subject to Mini-Circuits standard limited warranty and terms and conditions (collectively, "Standard Terms"); Purchasers of this part are entitled to the rights and benefits contained therein. For a full statement of the Standard Terms and the exclusive rights and remedies thereunder, please visit Mini-Circuits' website at [www.minicircuits.com/MCLStore/terms.jsp](http://www.minicircuits.com/MCLStore/terms.jsp).

Pin Configuration

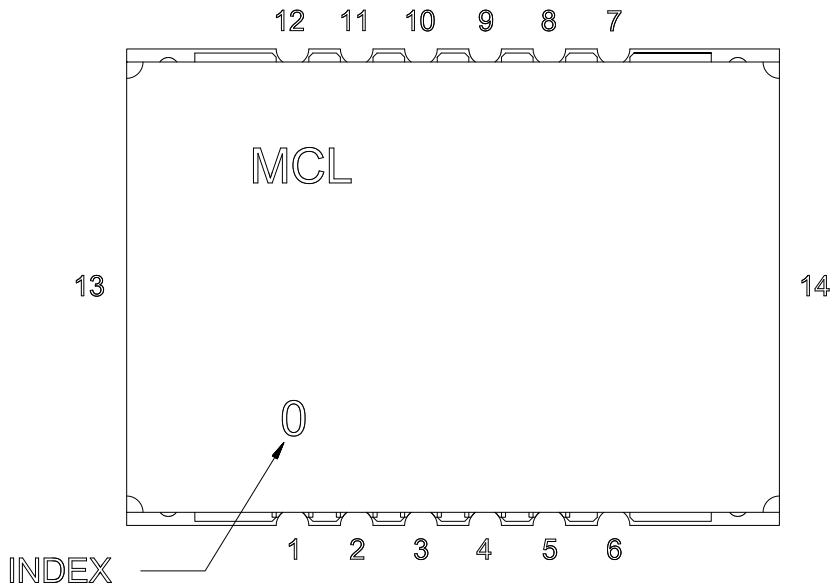

Pin Connection

Pin Number	Function
1	VCC PLL
2	GND
3	REF IN
4	GND
5	VCC VCO
6	GND
7	RF OUT
8	GND
9	LOCK DET
10	CLOCK
11	DATA
12	LE
13	GND
14	GND

Recommended Application Circuit

Note: REF IN and RF OUT ports are internally AC coupled.

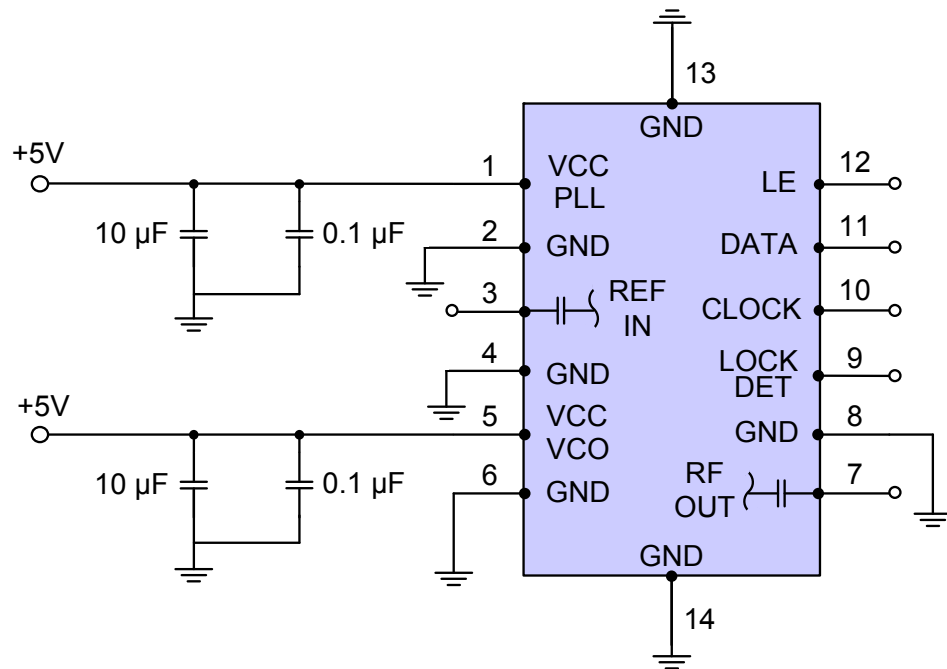

IF/RF MICROWAVE COMPONENTS • ISO 9001 ISO 14001 AS9100 CERTIFIED RoHS compliant  
 P.O. Box 350166, Brooklyn, New York 11235-0003 (718) 934-4500 Fax (718) 332-4661



The Design Engineers Search Engine finds the model you need, Instantly • For detailed performance specs & shopping online see



Notes: 1. Performance and quality attributes and conditions not expressly stated in this specification sheet are intended to be excluded and do not form a part of this specification sheet. 2. Electrical specifications and performance data contained herein are based on Mini-Circuit's applicable established test performance criteria and measurement instructions. 3. The parts covered by this specification sheet are subject to Mini-Circuits standard limited warranty and terms and conditions (collectively, "Standard Terms"); Purchasers of this part are entitled to the rights and benefits contained therein. For a full statement of the Standard Terms and the exclusive rights and remedies thereunder, please visit Mini-Circuits' website at [www.minicircuits.com/MCLStore/terms.jsp](http://www.minicircuits.com/MCLStore/terms.jsp).

## Device Marking

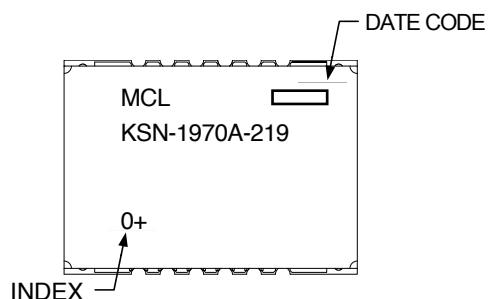

### Additional Detailed Technical Information

Additional information is available on our web site. To access this information enter the model number on our web site home page.

**Case Style:** DK1042

**Tape & Reel:** TR-F28

**Suggested Layout for PCB Design:** PL-249

**Evaluation Board:** TB-567+

**Environment Ratings:** ENV03T2



IF/RF MICROWAVE COMPONENTS • ISO 9001 ISO 14001 AS9100 CERTIFIED RoHS compliant

P.O. Box 350166, Brooklyn, New York 11235-0003 (718) 934-4500 Fax (718) 332-4661



Patent Pending

The Design Engineers Search Engine finds the model you need, Instantly • For detailed performance specs & shopping online see



Notes: 1. Performance and quality attributes and conditions not expressly stated in this specification sheet are intended to be excluded and do not form a part of this specification sheet. 2. Electrical specifications and performance data contained herein are based on Mini-Circuit's applicable established test performance criteria and measurement instructions. 3. The parts covered by this specification sheet are subject to Mini-Circuits standard limited warranty and terms and conditions (collectively, "Standard Terms"); Purchasers of this part are entitled to the rights and benefits contained therein. For a full statement of the Standard Terms and the exclusive rights and remedies thereunder, please visit Mini-Circuits' website at [www.minicircuits.com/MCLStore/terms.jsp](http://www.minicircuits.com/MCLStore/terms.jsp).