

Frequency Synthesizer

KSN-1827A+

50Ω 1714.76 to 1827.84 MHz

The Big Deal

- Fractional N synthesizer
- Low phase noise and spurious
- Robust design and construction
- Small size 0.80" x 0.58" x 0.15"



CASE STYLE: DK1042

Product Overview

The KSN-1827A+ is a Frequency Synthesizer, designed to operate from 1714.76 to 1827.84 MHz for TD-SCDMA application. The KSN-1827A+ is packaged in a metal case (size of 0.80" x 0.58" x 0.15") to shield against unwanted signals and noise.

Key Features

Feature	Advantages
Low phase noise and spurious: <ul style="list-style-type: none">• Phase Noise: -100 dBc/Hz typ. @10 kHz offset• Step Size Spurious: -85 dBc typ.• Comparison Spurious: -85 dBc typ.• Reference Spurious: -80 dBc typ.	Low phase noise and spurious improve system EVM (Error Vector Magnitude).
Robust design and construction	To enhance the robustness of KSN-1827A+, each internal component is secured to the substrate with chip bonder, thereby eliminating the risk of tombstoning during subsequent solder reflow operations by the customer.
Small size, 0.80" x 0.58" x 0.15"	The small size enables the KSN-1827A+ to be used in compact designs.



IF/RF MICROWAVE COMPONENTS • ISO 9001 ISO 14001 AS9100 CERTIFIED RoHS compliant
P.O. Box 350166, Brooklyn, New York 11235-0003 (718) 934-4500 Fax (718) 332-4661



The Design Engineers Search Engine finds the model you need, Instantly • For detailed performance specs & shopping online see



Notes: 1. Performance and quality attributes and conditions not expressly stated in this specification sheet are intended to be excluded and do not form a part of this specification sheet. 2. Electrical specifications and performance data contained herein are based on Mini-Circuit's applicable established test performance criteria and measurement instructions. 3. The parts covered by this specification sheet are subject to Mini-Circuits standard limited warranty and terms and conditions (collectively, "Standard Terms"); Purchasers of this part are entitled to the rights and benefits contained therein. For a full statement of the Standard Terms and the exclusive rights and remedies thereunder, please visit Mini-Circuits' website at www.minicircuits.com/MCLStore/terms.jsp.

50Ω 1714.76 to 1827.84 MHz

Features

- Fractional N synthesizer
- Integrated VCO + PLL
- Low phase noise and spurious
- Robust design and construction
- Low operating voltage (VCC VCO=+5V, VCC PLL=+5V)
- Small size 0.80" x 0.58" x 0.15"

Applications

- TD-SCDMA

General Description

The KSN-1827A+ is a Frequency Synthesizer, designed to operate from 1714.76 to 1827.84 MHz for TD-SCDMA application. The KSN-1827A+ is packaged in a metal case (size of 0.80" x 0.58" x 0.15) to shield against unwanted signals and noise. To enhance the robustness of KSN-1827A+, each internal component is secured to the substrate with chip bonder, thereby eliminating the risk of tombstoning during subsequent solder reflow operations by the customer.



CASE STYLE: DK1042
PRICE: \$29.95 ea. QTY (1-9)

+ RoHS compliant in accordance with EU Directive (2002/95/EC)

The +Suffix has been added in order to identify RoHS Compliance. See our web site for RoHS Compliance methodologies and qualifications.

Simplified Schematic



IF/RF MICROWAVE COMPONENTS • ISO 9001 ISO 14001 AS9100 CERTIFIED RoHS compliant
P.O. Box 350166, Brooklyn, New York 11235-0003 (718) 934-4500 Fax (718) 332-4661



The Design Engineers Search Engine finds the model you need, Instantly • For detailed performance specs & shopping online see



Notes: 1. Performance and quality attributes and conditions not expressly stated in this specification sheet are intended to be excluded and do not form a part of this specification sheet. 2. Electrical specifications and performance data contained herein are based on Mini-Circuit's applicable established test performance criteria and measurement instructions. 3. The parts covered by this specification sheet are subject to Mini-Circuits standard limited warranty and terms and conditions (collectively, "Standard Terms"); Purchasers of this part are entitled to the rights and benefits contained therein. For a full statement of the Standard Terms and the exclusive rights and remedies thereunder, please visit Mini-Circuits' website at www.minicircuits.com/MCLStore/terms.jsp.

Electrical Specifications (over operating temperature -40°C to +85°C)

Parameters	Test Conditions	Min.	Typ.	Max.	Units
Frequency Range	-	1714.76	-	1827.84	MHz
Step Size	-	-	20	-	kHz
Comparison Frequency	-	-	15.36	-	MHz
Settling Time	Within ± 1 kHz	-	55	-	mSec
Output Power	-	+1	+4	+7	dBm
SSB Phase Noise	@ 100 Hz offset	-	-75	-	dBc/Hz
	@ 1 kHz offset	-	-80	-76	
	@ 10 kHz offset	-	-100	-93	
	@ 100 kHz offset	-	-126	-120	
	@ 1 MHz offset	-	-146	-140	
Integrated SSB Phase Noise	@ 100 Hz to 5MHz	-	-45	-	dBc
Step Size Spurious Suppression	Step Size 20 kHz	-	-85	-65	dBc
0.5 Step Size Spurious Suppression	0.5 Step Size 10 kHz	-	-80	-60	
Reference Spurious Suppression	Ref. Freq. 30.72 MHz	-	-80	-70	
Comparison Spurious Suppression	Comp. Freq. 15.36 MHz	-	-85	-75	
Non - Harmonic Spurious Suppression	-	-	-90	-	
Harmonic Suppression	-	-	-25	-17	
VCO Supply Voltage	5.00	4.75	5.00	5.25	V
PLL Supply Voltage	5.00	4.75	5.00	5.25	
VCO Supply Current	-	-	51	60	mA
PLL Supply Current	-	-	20	30	
Reference Input (External)	Frequency	30.72 (square wave)	-	30.72	MHz
	Amplitude	1	-	1	V _{P-P}
	Input impedance	-	-	100	KΩ
	Phase Noise @ 1 kHz offset	-	-	-135	dBc/Hz
RF Output port Impedance	-	-	50	-	Ω
Input Logic Level	Input high voltage	-	2.55	-	V
	Input low voltage	-	-	0.55	V
Digital Lock Detect	Locked	-	2.35	3.15	V
	Unlocked	-	-	0.40	V
Frequency Synthesizer PLL	-	ADF4153			
PLL Programming	-	3-wire serial 3V CMOS			
Register Map @ 1827.84MHz	R0_Register	-	(MSB) 11101110000000000000 (LSB)		
	R1_Register	-	(MSB) 100001000110000000001 (LSB)		
	R2_Register	-	(MSB) 111100010 (LSB)		
	R3_Register	-	(MSB) 11 (LSB)		

Absolute Maximum Ratings

Parameters	Ratings
VCO Supply Voltage	5.8V
PLL Supply Voltage	5.8V
VCO Supply Voltage to PLL Supply Voltage	-0.3V to +5.8V
Reference Frequency Voltage	-0.3Vmin, +3.05Vmax
Data, Clock, LE Levels	-0.3Vmin, +3.05Vmax
Operating Temperature	-40°C to +85°C
Storage Temperature	-55°C to +100°C

Permanent damage may occur if any of these limits are exceeded



The Design Engineers Search Engine finds the model you need, Instantly • For detailed performance specs & shopping online see minicircuits.com

Notes: 1. Performance and quality attributes and conditions not expressly stated in this specification sheet are intended to be excluded and do not form a part of this specification sheet. 2. Electrical specifications and performance data contained herein are based on Mini-Circuit's applicable established test performance criteria and measurement instructions. 3. The parts covered by this specification sheet are subject to Mini-Circuits standard limited warranty and terms and conditions (collectively, "Standard Terms"); Purchasers of this part are entitled to the rights and benefits contained therein. For a full statement of the Standard Terms and the exclusive rights and remedies thereunder, please visit Mini-Circuits' website at www.minicircuits.com/MCLStore/terms.jsp.

Typical Performance Data

FREQUENCY (MHz)	POWER OUTPUT (dBm)			VCO CURRENT (mA)			PLL CURENT (mA)		
	-45°C	+25°C	+85°C	-45°C	+25°C	+85°C	-45°C	+25°C	+85°C
1714.76	4.24	4.13	4.08	50.96	51.36	52.74	18.61	20.07	22.62
1714.80	4.23	4.13	4.08	50.95	51.36	52.74	18.62	20.07	22.64
1729.60	4.23	4.08	4.04	50.98	51.38	52.77	18.60	20.07	22.63
1744.40	4.17	4.06	4.00	50.41	51.39	52.77	18.67	20.15	22.72
1759.20	4.13	4.06	3.99	49.83	51.40	52.77	18.67	20.15	22.72
1774.00	4.22	4.12	4.00	50.99	51.43	52.77	18.66	20.15	22.72
1788.80	4.22	4.14	3.98	50.96	51.44	52.77	18.59	20.09	22.66
1803.60	4.20	4.14	3.95	50.91	51.41	52.74	18.63	20.14	22.70
1818.40	4.14	4.09	3.89	50.82	51.35	52.71	18.60	20.11	22.68
1827.84	4.11	4.05	3.84	50.78	51.31	52.69	17.29	18.75	21.20

FREQUENCY (MHz)	HARMONICS (dBc)					
	F2			F3		
	-45°C	+25°C	+85°C	-45°C	+25°C	+85°C
1714.76	-23.85	-24.97	-27.18	-22.90	-24.81	-28.82
1714.80	-23.84	-24.98	-27.19	-22.89	-24.77	-28.84
1729.60	-23.68	-24.73	-26.95	-23.48	-25.39	-28.87
1744.40	-23.49	-24.58	-26.81	-24.65	-26.77	-30.41
1759.20	-23.02	-24.19	-26.46	-25.09	-27.09	-30.67
1774.00	-23.46	-24.60	-26.81	-25.30	-27.41	-30.97
1788.80	-23.25	-24.45	-26.70	-26.26	-27.86	-31.39
1803.60	-23.80	-25.23	-27.34	-28.62	-30.63	-33.96
1818.40	-24.05	-25.54	-27.77	-28.63	-30.31	-33.83
1827.84	-23.93	-25.45	-27.72	-29.99	-31.60	-34.49



IF/RF MICROWAVE COMPONENTS • ISO 9001 ISO 14001 AS9100 CERTIFIED RoHS compliant
 P.O. Box 350166, Brooklyn, New York 11235-0003 (718) 934-4500 Fax (718) 332-4661



The Design Engineers Search Engine finds the model you need, Instantly • For detailed performance specs & shopping online see



Notes: 1. Performance and quality attributes and conditions not expressly stated in this specification sheet are intended to be excluded and do not form a part of this specification sheet. 2. Electrical specifications and performance data contained herein are based on Mini-Circuit's applicable established test performance criteria and measurement instructions. 3. The parts covered by this specification sheet are subject to Mini-Circuits standard limited warranty and terms and conditions (collectively, "Standard Terms"); Purchasers of this part are entitled to the rights and benefits contained therein. For a full statement of the Standard Terms and the exclusive rights and remedies thereunder, please visit Mini-Circuits' website at www.minicircuits.com/MCLStore/terms.jsp.

FREQUENCY (MHz)	PHASE NOISE (dBc/Hz) @ OFFSETS				
	+25°C				
	100Hz	1kHz	10kHz	100kHz	1MHz
1714.76	-77.27	-85.04	-102.43	-126.77	-147.01
1714.80	-78.78	-84.24	-102.24	-126.92	-147.05
1729.60	-77.12	-84.14	-103.18	-126.60	-146.84
1744.40	-75.42	-83.23	-102.09	-126.70	-146.79
1759.20	-76.91	-82.58	-101.87	-126.31	-146.58
1774.00	-76.65	-83.99	-102.30	-126.41	-146.69
1788.80	-73.57	-83.50	-102.30	-126.21	-146.33
1803.60	-76.73	-83.42	-101.25	-125.81	-146.16
1818.40	-77.56	-82.79	-97.64	-124.03	-145.46
1827.84	-76.72	-83.51	-100.69	-125.08	-145.38

FREQUENCY (MHz)	PHASE NOISE (dBc/Hz) @ OFFSETS				
	-45°C				
	100Hz	1kHz	10kHz	100kHz	1MHz
1714.76	-76.33	-81.62	-100.24	-127.68	-147.93
1714.80	-77.49	-83.26	-102.29	-127.78	-147.88
1729.60	-74.73	-82.61	-102.30	-127.59	-147.78
1744.40	-75.33	-80.96	-101.58	-128.36	-148.79
1759.20	-74.83	-79.39	-102.93	-128.34	-148.92
1774.00	-75.25	-82.68	-101.57	-127.12	-147.41
1788.80	-77.58	-81.29	-101.91	-126.69	-147.03
1803.60	-76.21	-82.27	-101.16	-126.35	-146.72
1818.40	-76.72	-80.92	-99.45	-125.27	-146.21
1827.84	-77.92	-82.33	-100.68	-125.53	-146.01

FREQUENCY (MHz)	PHASE NOISE (dBc/Hz) @ OFFSETS				
	+85°C				
	100Hz	1kHz	10kHz	100kHz	1MHz
1714.76	-79.86	-85.33	-99.98	-125.17	-145.36
1714.80	-75.70	-84.79	-101.74	-125.05	-145.25
1729.60	-75.60	-82.97	-101.76	-124.90	-145.05
1744.40	-77.38	-82.76	-101.43	-124.93	-144.94
1759.20	-77.67	-81.62	-101.09	-124.58	-144.96
1774.00	-82.85	-84.51	-101.05	-124.27	-144.46
1788.80	-77.32	-83.25	-100.27	-123.99	-144.30
1803.60	-75.13	-84.32	-100.20	-123.68	-143.81
1818.40	-75.48	-80.88	-98.08	-122.89	-143.45
1827.84	-75.12	-83.39	-98.92	-123.09	-143.16



IF/RF MICROWAVE COMPONENTS • ISO 9001 ISO 14001 AS9100 CERTIFIED RoHS compliant
 P.O. Box 350166, Brooklyn, New York 11235-0003 (718) 934-4500 Fax (718) 332-4661



The Design Engineers Search Engine finds the model you need, Instantly • For detailed performance specs & shopping online see



Notes: 1. Performance and quality attributes and conditions not expressly stated in this specification sheet are intended to be excluded and do not form a part of this specification sheet. 2. Electrical specifications and performance data contained herein are based on Mini-Circuit's applicable established test performance criteria and measurement instructions. 3. The parts covered by this specification sheet are subject to Mini-Circuits standard limited warranty and terms and conditions (collectively, "Standard Terms"); Purchasers of this part are entitled to the rights and benefits contained therein. For a full statement of the Standard Terms and the exclusive rights and remedies thereunder, please visit Mini-Circuits' website at www.minicircuits.com/MCLStore/terms.jsp.

COMPARISON SPURIOUS ORDER	COMPARISON SPURIOUS @Fcarrier 1714.76MHz+(n*Fcomparison) (dBc) note 1			COMPARISON SPURIOUS @Fcarrier 1773MHz+(n*Fcomparison) (dBc) note 1			COMPARISON SPURIOUS @Fcarrier 1827.44MHz+(n*Fcomparison) (dBc) note 1			
	n	-45°C	+25°C	+85°C	-45°C	+25°C	+85°C	-45°C	+25°C	+85°C
	-5	-87.47	-89.45	-96.78	-87.94	-91.56	-97.09	-92.54	-92.47	-93.95
-4	-91.34	-94.41	-93.29	-91.82	-92.59	-97.68	-93.74	-94.57	-99.25	
-3	-99.84	-95.96	-101.65	-100.17	-101.83	-113.47	-110.19	-115.27	-104.57	
-2	-96.40	-90.79	-98.52	-93.62	-97.87	-98.21	-94.18	-94.89	-91.93	
-1	-92.30	-90.54	-102.84	-98.12	-100.50	-101.87	-98.25	-99.13	-93.06	
0 note 2	-	-	-	-	-	-	-	-	-	
+1	-91.09	-92.21	-90.62	-91.80	-89.83	-90.36	-92.06	-93.55	-95.64	
+2	-95.71	-99.35	-99.04	-98.97	-93.57	-96.57	-95.54	-98.53	-104.11	
+3	-99.10	-104.14	-106.86	-112.32	-103.17	-111.34	-100.98	-104.25	-108.61	
+4	-93.28	-93.87	-97.18	-95.01	-99.23	-97.15	-99.97	-109.30	-100.22	
+5	-84.86	-85.65	-86.96	-86.26	-87.75	-89.16	-89.98	-90.55	-91.89	

Note 1: Comparison frequency 15.36 MHz
 Note 2: All spurs are referenced to carrier signal (n=0).

REFERENCE SPURIOUS ORDER	REFERENCE SPURIOUS @Fcarrier 1714.76MHz+(n*Frefernce) (dBc) note 3			REFERENCE SPURIOUS @Fcarrier 1773MHz+(n*Frefernce) (dBc) note 3			REFERENCE SPURIOUS @Fcarrier 1827.44MHz+(n*Frefernce) (dBc) note 3			
	n	-45°C	+25°C	+85°C	-45°C	+25°C	+85°C	-45°C	+25°C	+85°C
	-5	-84.73	-88.24	-92.97	-85.84	-86.19	-93.56	-86.12	-91.40	-89.41
-4	-84.93	-84.17	-83.71	-91.04	-88.74	-89.16	-81.27	-81.88	-82.25	
-3	-85.40	-84.65	-83.67	-92.26	-95.09	-92.48	-96.43	-94.97	-97.71	
-2	-91.34	-94.41	-93.29	-91.82	-92.59	-97.68	-93.74	-94.57	-99.25	
-1	-96.40	-90.79	-98.52	-93.62	-97.87	-98.21	-94.18	-94.89	-91.93	
0 note 4	-	-	-	-	-	-	-	-	-	
+1	-95.71	-99.35	-99.04	-98.97	-93.57	-96.57	-95.54	-98.53	-104.11	
+2	-93.28	-93.87	-97.18	-95.01	-99.23	-97.15	-99.97	-109.30	-100.22	
+3	-83.57	-83.72	-82.66	-85.94	-87.19	-89.06	-90.08	-89.64	-92.62	
+4	-81.59	-82.77	-83.04	-85.52	-86.45	-86.17	-77.82	-78.07	-77.28	
+5	-80.89	-83.74	-89.02	-79.96	-82.56	-88.75	-80.81	-84.42	-89.56	

Note 3: Reference frequency 30.72 MHz
 Note 4: All spurs are referenced to carrier signal (n=0).



IF/RF MICROWAVE COMPONENTS • ISO 9001 ISO 14001 AS9100 CERTIFIED RoHS compliant
 P.O. Box 350166, Brooklyn, New York 11235-0003 (718) 934-4500 Fax (718) 332-4661



The Design Engineers Search Engine finds the model you need, Instantly • For detailed performance specs & shopping online see



Notes: 1. Performance and quality attributes and conditions not expressly stated in this specification sheet are intended to be excluded and do not form a part of this specification sheet. 2. Electrical specifications and performance data contained herein are based on Mini-Circuit's applicable established test performance criteria and measurement instructions. 3. The parts covered by this specification sheet are subject to Mini-Circuits standard limited warranty and terms and conditions (collectively, "Standard Terms"); Purchasers of this part are entitled to the rights and benefits contained therein. For a full statement of the Standard Terms and the exclusive rights and remedies thereunder, please visit Mini-Circuits' website at www.minicircuits.com/MCLStore/terms.jsp.

STEP SIZE SPURIOUS ORDER n	0.5 STEP SIZE & STEP SIZE SPURIOUS @Fcarrier 1714.76MHz+(n*Fstep size) (dBc) note 5			0.5 STEP SIZE & STEP SIZE SPURIOUS @Fcarrier 1773MHz+(n*Fstep size) (dBc) note 5			0.5 STEP SIZE & STEP SIZE SPURIOUS @Fcarrier 1827.44MHz+(n*Fstep size) (dBc) note 5		
	-45°C	+25°C	+85°C	-45°C	+25°C	+85°C	-45°C	+25°C	+85°C
-5.0	-80.31	-86.08	-82.33	-86.26	-80.37	-87.14	-86.85	-86.11	-82.97
-4.5	-84.70	-85.42	-86.72	-86.92	-83.58	-85.84	-86.35	-86.94	-87.10
-4.0	-86.76	-86.54	-86.21	-86.17	-86.63	-83.70	-86.41	-87.04	-84.75
-3.5	-85.96	-84.84	-84.30	-85.06	-85.34	-81.61	-82.34	-87.41	-82.82
-3.0	-84.73	-86.36	-82.07	-86.57	-82.58	-87.35	-84.54	-84.21	-85.57
-2.5	-86.94	-86.59	-84.93	-84.96	-80.79	-84.09	-79.02	-80.35	-85.84
-2.0	-85.83	-85.04	-87.97	-86.72	-88.26	-87.39	-87.02	-85.35	-87.40
-1.5	-81.82	-83.33	-81.54	-82.24	-78.24	-79.93	-81.82	-82.50	-81.15
-1.0	-86.66	-82.85	-83.42	-84.64	-85.81	-87.01	-84.89	-84.04	-83.08
-0.5	-77.28	-78.74	-77.31	-78.16	-82.67	-77.87	-78.69	-79.69	-78.00
0 note 6	-	-	-	-	-	-	-	-	-
+0.5	-77.34	-79.57	-77.33	-80.36	-81.17	-78.42	-77.89	-77.15	-79.60
+1.0	-85.86	-86.69	-86.10	-88.52	-87.27	-81.33	-82.94	-86.31	-84.84
+1.5	-82.23	-79.13	-84.84	-83.21	-77.87	-80.63	-81.44	-80.24	-80.49
+2.0	-88.68	-83.92	-84.15	-84.00	-82.76	-87.06	-79.71	-80.53	-79.25
+2.5	-84.05	-86.80	-85.92	-87.03	-87.35	-82.59	-87.35	-86.99	-83.56
+3.0	-84.60	-81.96	-85.19	-83.13	-85.10	-85.89	-82.60	-86.48	-83.54
+3.5	-83.09	-82.97	-83.00	-84.97	-86.41	-86.99	-83.92	-82.01	-86.86
+4.0	-85.21	-85.39	-86.65	-85.07	-83.77	-82.40	-85.14	-85.83	-86.04
+4.5	-86.71	-87.27	-86.29	-87.54	-85.49	-84.28	-83.01	-82.30	-82.31
+5.0	-82.15	-88.13	-85.72	-85.25	-83.97	-87.42	-84.00	-86.86	-86.99

Note 5: Step size 20 kHz

Note 6: All spurs are referenced to carrier signal (n=0).



IF/RF MICROWAVE COMPONENTS • ISO 9001 ISO 14001 AS9100 CERTIFIED RoHS compliant
P.O. Box 350166, Brooklyn, New York 11235-0003 (718) 934-4500 Fax (718) 332-4661



The Design Engineers Search Engine finds the model you need, Instantly • For detailed performance specs & shopping online see



Notes: 1. Performance and quality attributes and conditions not expressly stated in this specification sheet are intended to be excluded and do not form a part of this specification sheet. 2. Electrical specifications and performance data contained herein are based on Mini-Circuit's applicable established test performance criteria and measurement instructions. 3. The parts covered by this specification sheet are subject to Mini-Circuits standard limited warranty and terms and conditions (collectively, "Standard Terms"); Purchasers of this part are entitled to the rights and benefits contained therein. For a full statement of the Standard Terms and the exclusive rights and remedies thereunder, please visit Mini-Circuits' website at www.minicircuits.com/MCLStore/terms.jsp.

Typical Performance Curves

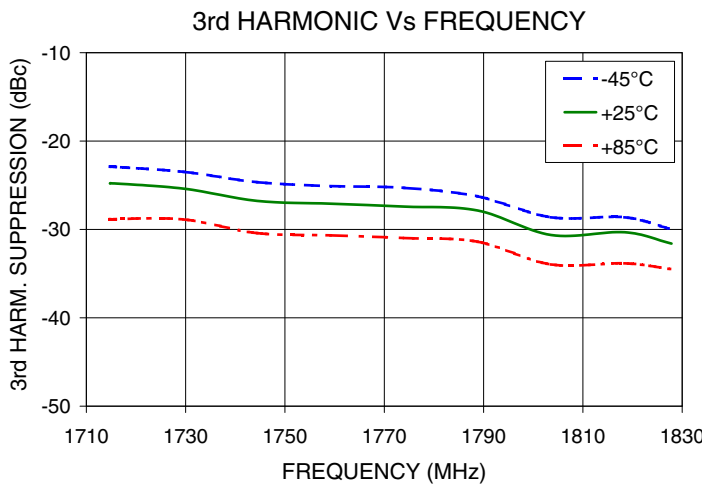
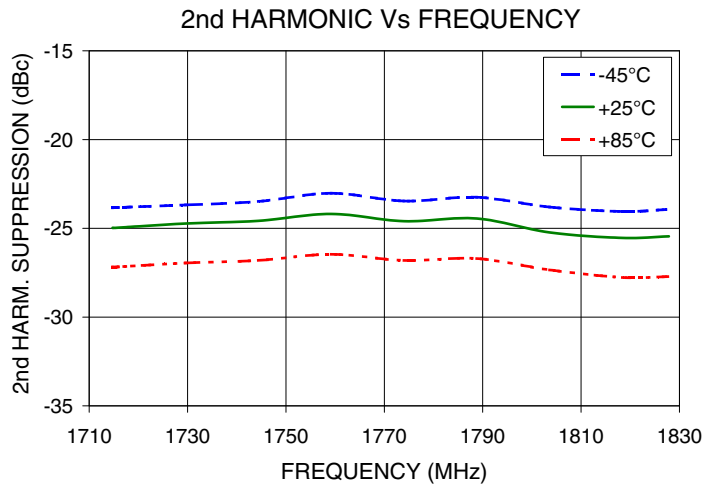
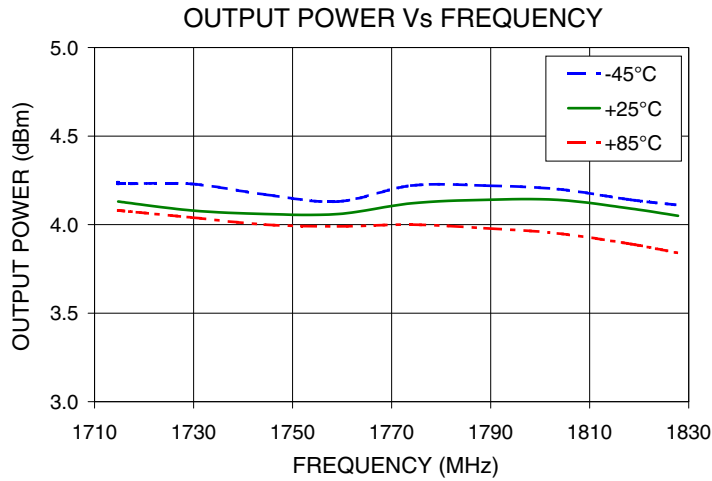

IF/RF MICROWAVE COMPONENTS • ISO 9001 ISO 14001 AS9100 CERTIFIED RoHS compliant
 P.O. Box 350166, Brooklyn, New York 11235-0003 (718) 934-4500 Fax (718) 332-4661



The Design Engineers Search Engine finds the model you need, Instantly • For detailed performance specs & shopping online see



Notes: 1. Performance and quality attributes and conditions not expressly stated in this specification sheet are intended to be excluded and do not form a part of this specification sheet. 2. Electrical specifications and performance data contained herein are based on Mini-Circuit's applicable established test performance criteria and measurement instructions. 3. The parts covered by this specification sheet are subject to Mini-Circuits standard limited warranty and terms and conditions (collectively, "Standard Terms"); Purchasers of this part are entitled to the rights and benefits contained therein. For a full statement of the Standard Terms and the exclusive rights and remedies thereunder, please visit Mini-Circuits' website at www.minicircuits.com/MCLStore/terms.jsp.

PHASE NOISE @ 100Hz offset

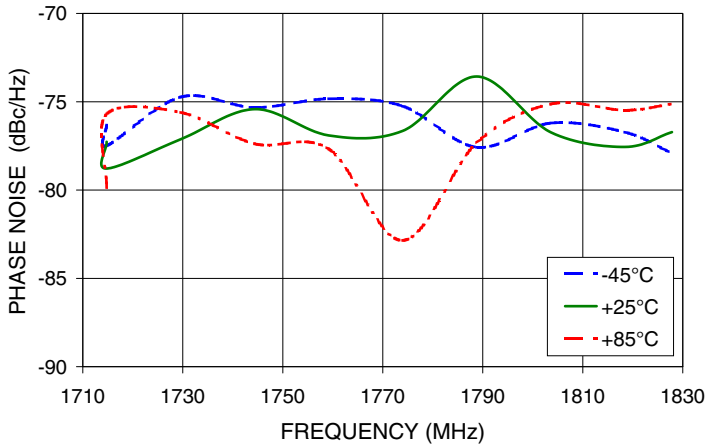

PHASE NOISE @ 1kHz offset

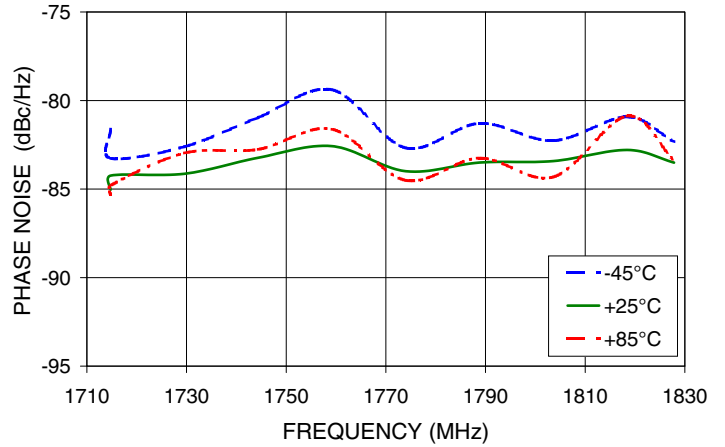

PHASE NOISE @ 10kHz offset

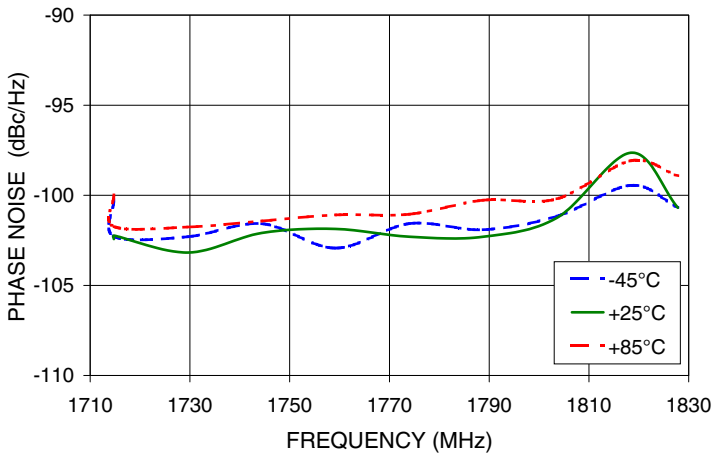

PHASE NOISE @ 100kHz offset

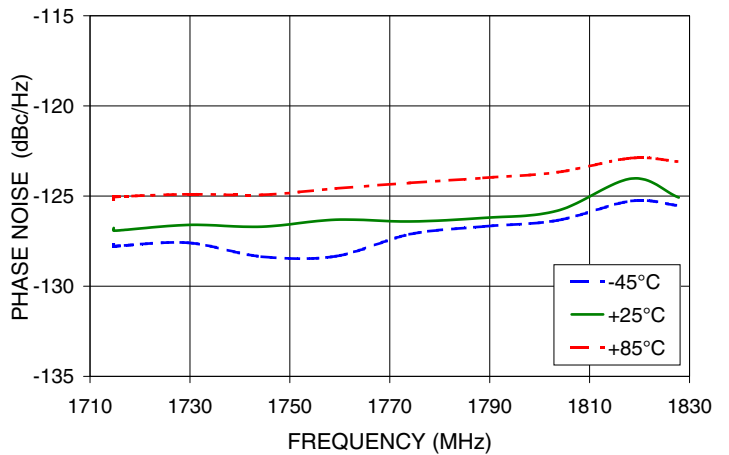

PHASE NOISE @ 1MHz offset

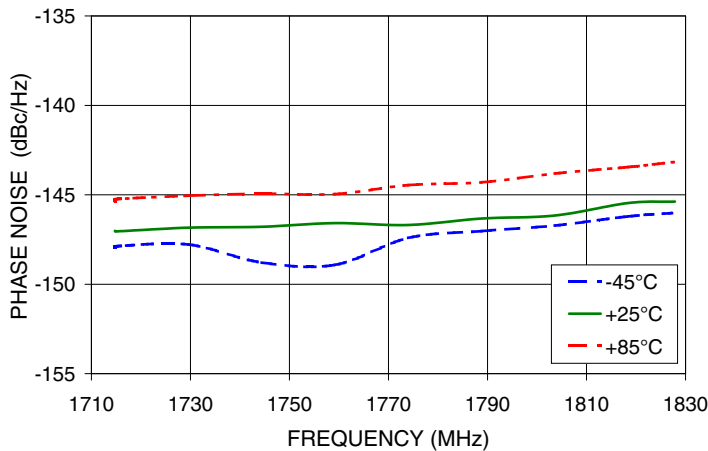

IF/RF MICROWAVE COMPONENTS • ISO 9001 ISO 14001 AS9100 CERTIFIED RoHS compliant
 P.O. Box 350166, Brooklyn, New York 11235-0003 (718) 934-4500 Fax (718) 332-4661



The Design Engineers Search Engine finds the model you need, Instantly • For detailed performance specs & shopping online see



Notes: 1. Performance and quality attributes and conditions not expressly stated in this specification sheet are intended to be excluded and do not form a part of this specification sheet. 2. Electrical specifications and performance data contained herein are based on Mini-Circuit's applicable established test performance criteria and measurement instructions. 3. The parts covered by this specification sheet are subject to Mini-Circuits standard limited warranty and terms and conditions (collectively, "Standard Terms"); Purchasers of this part are entitled to the rights and benefits contained therein. For a full statement of the Standard Terms and the exclusive rights and remedies thereunder, please visit Mini-Circuits' website at www.minicircuits.com/MCLStore/terms.jsp.

COMPARISON SPURIOUS
Vs FREQ. OFFSET @ Fcar = 1714.76MHz

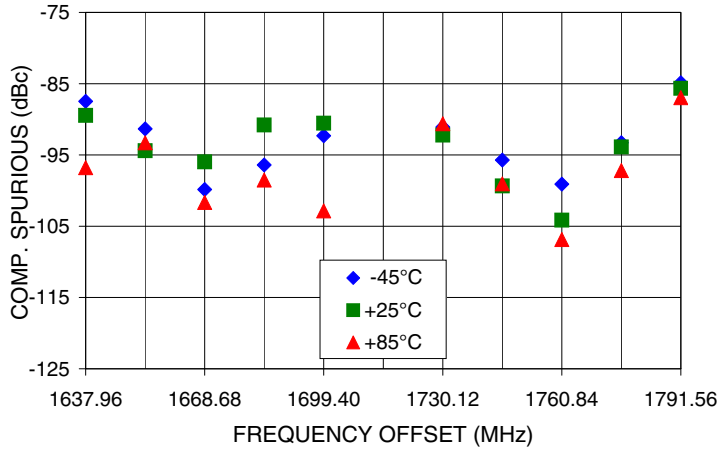

REFERENCE SPURIOUS
Vs FREQ. OFFSET @ Fcar = 1714.76MHz

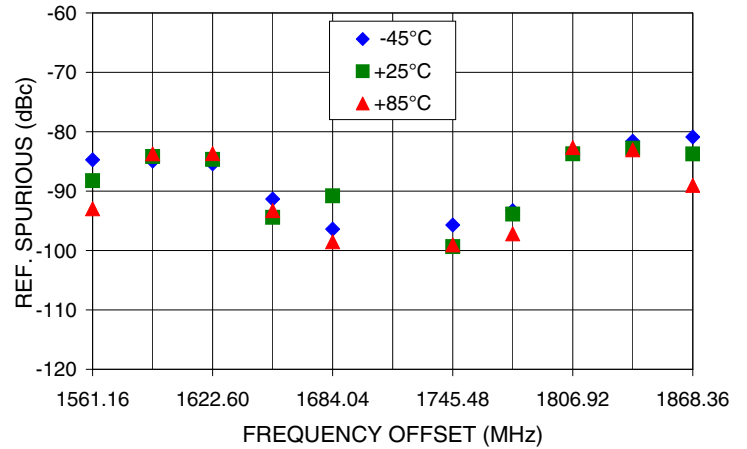

COMPARISON SPURIOUS
Vs FREQ. OFFSET @ Fcar = 1773MHz

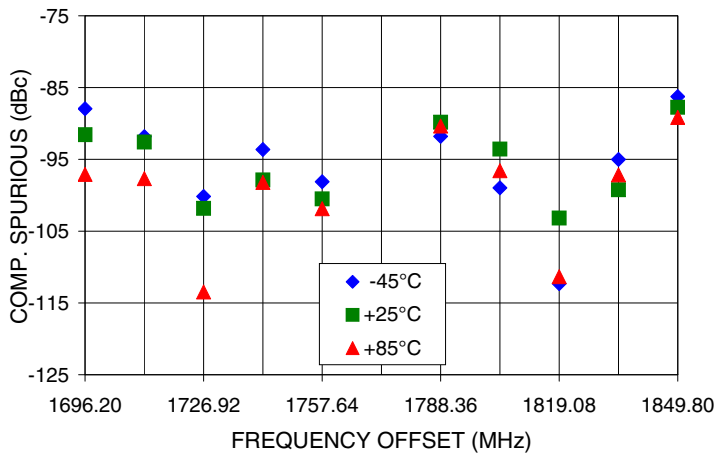

REFERENCE SPURIOUS
Vs FREQ. OFFSET @ Fcar = 1773MHz

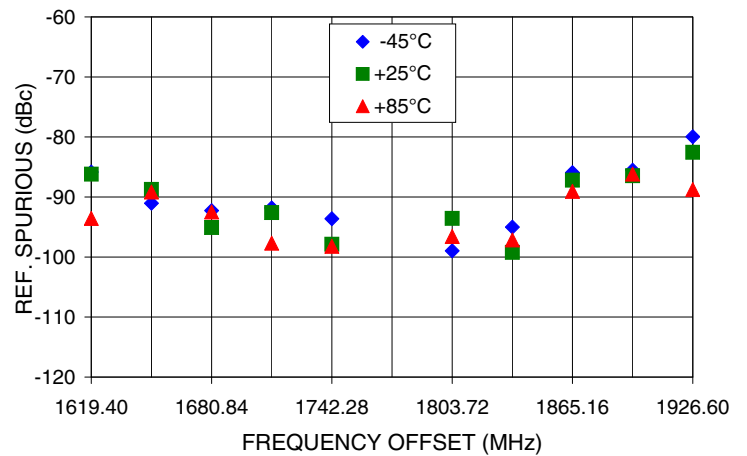

COMPARISON SPURIOUS
Vs FREQ. OFFSET @ Fcar = 1827.44MHz

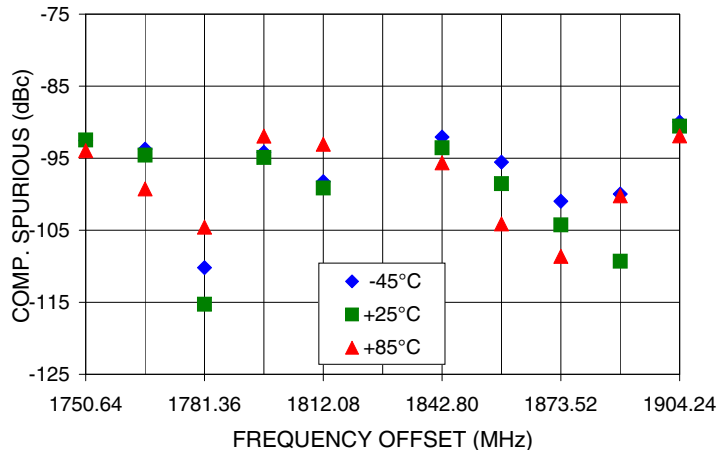

REFERENCE SPURIOUS
Vs FREQ. OFFSET @ Fcar = 1827.44MHz

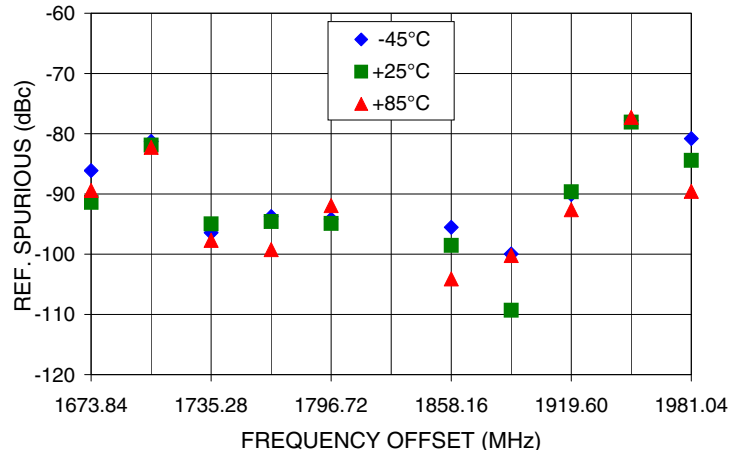

IF/RF MICROWAVE COMPONENTS • ISO 9001 ISO 14001 AS9100 CERTIFIED RoHS compliant
P.O. Box 350166, Brooklyn, New York 11235-0003 (718) 934-4500 Fax (718) 332-4661



The Design Engineers Search Engine finds the model you need, Instantly • For detailed performance specs & shopping online see



Notes: 1. Performance and quality attributes and conditions not expressly stated in this specification sheet are intended to be excluded and do not form a part of this specification sheet. 2. Electrical specifications and performance data contained herein are based on Mini-Circuit's applicable established test performance criteria and measurement instructions. 3. The parts covered by this specification sheet are subject to Mini-Circuits standard limited warranty and terms and conditions (collectively, "Standard Terms"); Purchasers of this part are entitled to the rights and benefits contained therein. For a full statement of the Standard Terms and the exclusive rights and remedies thereunder, please visit Mini-Circuits' website at www.minicircuits.com/MCLStore/terms.jsp.

0.5 STEP SIZE & STEP SIZE SPURIOUS
Vs FREQ. OFFSET @ Fcar = 1714.76MHz

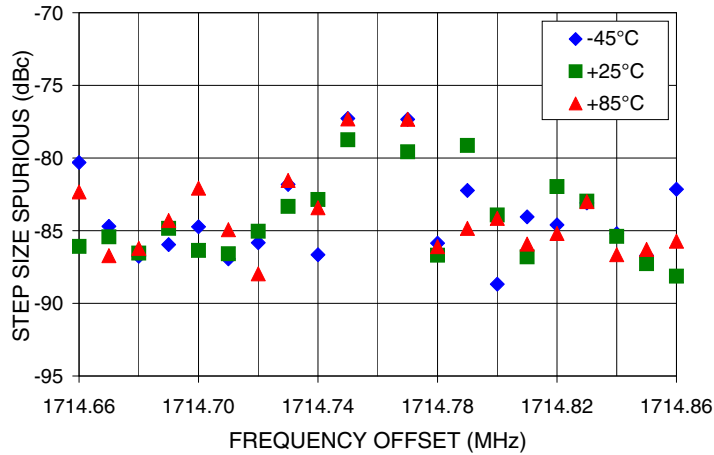

0.5 STEP SIZE & STEP SIZE SPURIOUS
Vs FREQ. OFFSET @ Fcar = 1773MHz

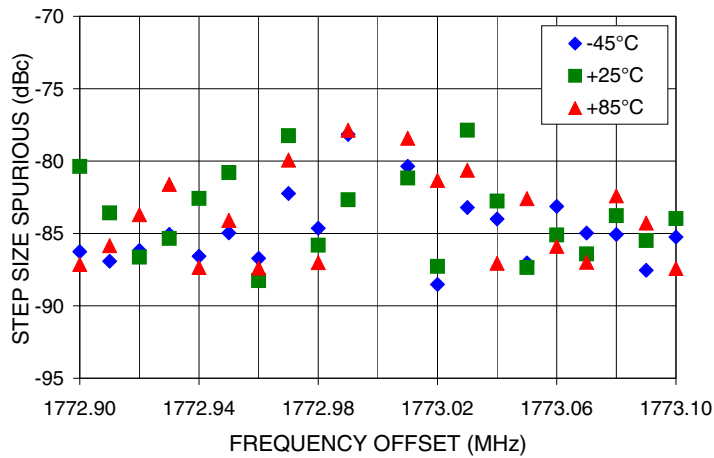

0.5 STEP SIZE & STEP SIZE SPURIOUS
Vs FREQ. OFFSET @ Fcar = 1827.44MHz

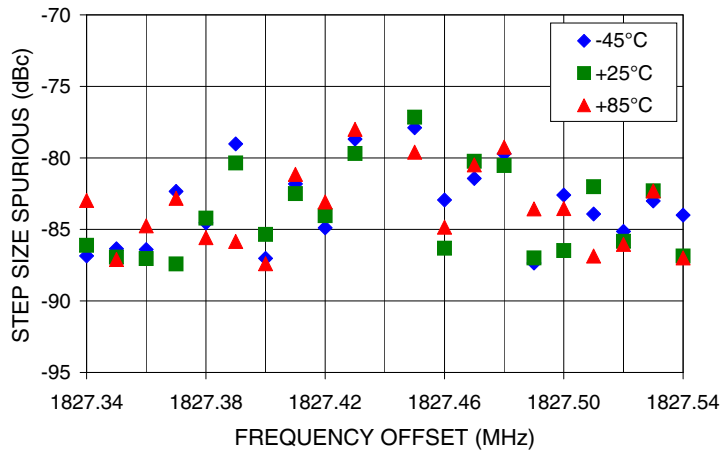

IF/RF MICROWAVE COMPONENTS • ISO 9001 ISO 14001 AS9100 CERTIFIED RoHS compliant
P.O. Box 350166, Brooklyn, New York 11235-0003 (718) 934-4500 Fax (718) 332-4661



The Design Engineers Search Engine finds the model you need, Instantly • For detailed performance specs & shopping online see



Notes: 1. Performance and quality attributes and conditions not expressly stated in this specification sheet are intended to be excluded and do not form a part of this specification sheet. 2. Electrical specifications and performance data contained herein are based on Mini-Circuit's applicable established test performance criteria and measurement instructions. 3. The parts covered by this specification sheet are subject to Mini-Circuits standard limited warranty and terms and conditions (collectively, "Standard Terms"); Purchasers of this part are entitled to the rights and benefits contained therein. For a full statement of the Standard Terms and the exclusive rights and remedies thereunder, please visit Mini-Circuits' website at www.minicircuits.com/MCLStore/terms.jsp.

Pin Configuration

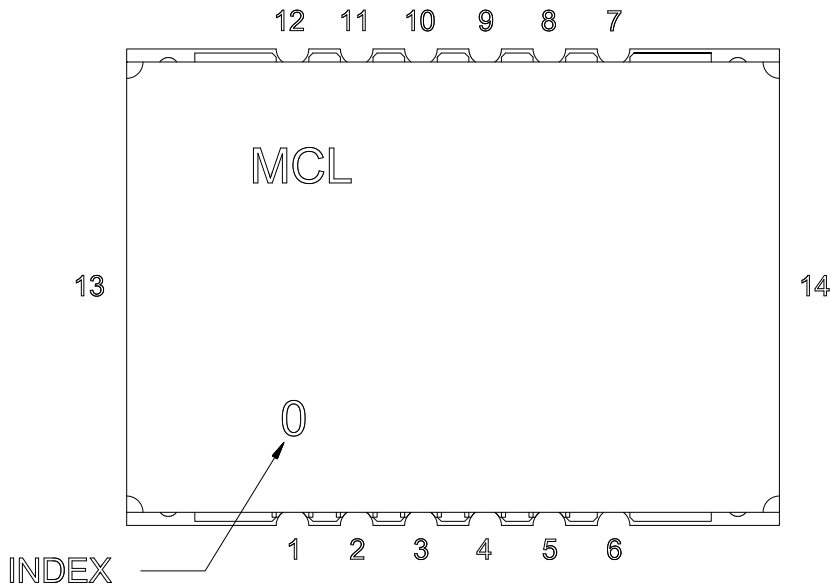

Pin Connection

Pin Number	Function
1	VCC PLL
2	GND
3	REF IN
4	GND
5	VCC VCO
6	GND
7	RF OUT
8	GND
9	LOCK DET
10	CLOCK
11	DATA
12	LE
13	GND
14	GND

Recommended Application Circuit

Note: REF IN and RF OUT ports are internally AC coupled.

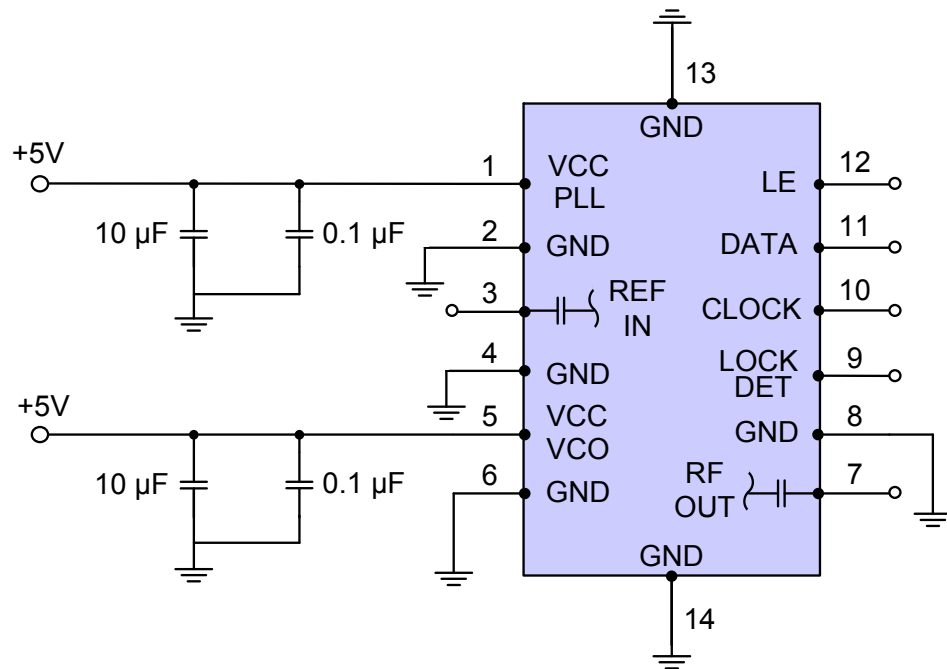

IF/RF MICROWAVE COMPONENTS • ISO 9001 ISO 14001 AS9100 CERTIFIED RoHS compliant
 P.O. Box 350166, Brooklyn, New York 11235-0003 (718) 934-4500 Fax (718) 332-4661



The Design Engineers Search Engine finds the model you need, Instantly • For detailed performance specs & shopping online see



Notes: 1. Performance and quality attributes and conditions not expressly stated in this specification sheet are intended to be excluded and do not form a part of this specification sheet. 2. Electrical specifications and performance data contained herein are based on Mini-Circuit's applicable established test performance criteria and measurement instructions. 3. The parts covered by this specification sheet are subject to Mini-Circuits standard limited warranty and terms and conditions (collectively, "Standard Terms"); Purchasers of this part are entitled to the rights and benefits contained therein. For a full statement of the Standard Terms and the exclusive rights and remedies thereunder, please visit Mini-Circuits' website at www.minicircuits.com/MCLStore/terms.jsp.

Device Marking

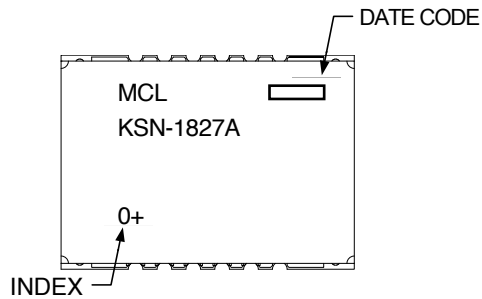

Additional Detailed Technical Information

Additional information is available on our web site. To access this information enter the model number on our web site home page.

Case Style: DK1042

Tape & Reel: TR-F28

Suggested Layout for PCB Design: PL-249

Evaluation Board: TB-567+

Environment Ratings: ENV03T2



IF/RF MICROWAVE COMPONENTS • ISO 9001 ISO 14001 AS9100 CERTIFIED RoHS compliant
P.O. Box 350166, Brooklyn, New York 11235-0003 (718) 934-4500 Fax (718) 332-4661



The Design Engineers Search Engine finds the model you need, Instantly • For detailed performance specs & shopping online see



Notes: 1. Performance and quality attributes and conditions not expressly stated in this specification sheet are intended to be excluded and do not form a part of this specification sheet. 2. Electrical specifications and performance data contained herein are based on Mini-Circuit's applicable established test performance criteria and measurement instructions. 3. The parts covered by this specification sheet are subject to Mini-Circuits standard limited warranty and terms and conditions (collectively, "Standard Terms"); Purchasers of this part are entitled to the rights and benefits contained therein. For a full statement of the Standard Terms and the exclusive rights and remedies thereunder, please visit Mini-Circuits' website at www.minicircuits.com/MCLStore/terms.jsp.