

Frequency Synthesizer

KSN-1590A-119+

50Ω 1567.5 to 1582.5 MHz

The Big Deal

- Fractional N synthesizer
- Low phase noise and spurious
- Robust design and construction
- Small size 0.80" x 0.58" x 0.24"



CASE STYLE: DK1171

Product Overview

The KSN-1590A-119+ is a Frequency Synthesizer, designed to operate from 1567.5 to 1582.5 MHz for CDMA cellular basestation application. The KSN-1590A-119+ is packaged in a metal case (size of 0.80" x 0.58" x 0.24") to shield against unwanted signals and noise.

Key Features

Feature	Advantages
Low phase noise and spurious: <ul style="list-style-type: none">• Phase Noise: -109 dBc/Hz typ. @ 10 kHz offset• Step Size Spurious: -95 dBc typ.• Comparison Spurious: -90 dBc typ.• Reference Spurious: -90 dBc typ.	Low phase noise and spurious improve system EVM (Error Vector Magnitude).
Robust design and construction	To enhance the robustness of KSN-1590A-119+, each internal component is secured to the substrate with chip bonder, thereby eliminating the risk of tombstoning during subsequent solder reflow operations by the customer.
Small size, 0.80" x 0.58" x 0.24"	The small size enables the KSN-1590A-119+ to be used in compact designs.



IF/RF MICROWAVE COMPONENTS • ISO 9001 ISO 14001 AS9100 CERTIFIED RoHS compliant
P.O. Box 350166, Brooklyn, New York 11235-0003 (718) 934-4500 Fax (718) 332-4661



The Design Engineers Search Engine finds the model you need, Instantly • For detailed performance specs & shopping online see



Notes: 1. Performance and quality attributes and conditions not expressly stated in this specification sheet are intended to be excluded and do not form a part of this specification sheet. 2. Electrical specifications and performance data contained herein are based on Mini-Circuit's applicable established test performance criteria and measurement instructions. 3. The parts covered by this specification sheet are subject to Mini-Circuits standard limited warranty and terms and conditions (collectively, "Standard Terms"); Purchasers of this part are entitled to the rights and benefits contained therein. For a full statement of the Standard Terms and the exclusive rights and remedies thereunder, please visit Mini-Circuits' website at www.minicircuits.com/MCLStore/terms.jsp.

Electrical Specifications (over operating temperature -40°C to +85°C)

Parameters	Test Conditions	Min.	Typ.	Max.	Units	
Frequency Range	-	1567.5	-	1582.5	MHz	
Step Size	-	-	250	-	kHz	
Comparison Frequency	-	-	30	-	MHz	
Settling Time	Within ± 1 kHz	-	8	-	mSec	
Output Power	-	-2.0	+1.7	+4.0	dBm	
SSB Phase Noise	@ 100 Hz offset	-	-86	-	dBc/Hz	
	@ 1 kHz offset	-	-95	-85		
	@ 10 kHz offset	-	-108	-105		
	@ 100 kHz offset	-	-135	-125		
	@ 1 MHz offset	-	-154	-137		
Step Size Spurious Suppression	Step Size 250 kHz	-	-95	-70	dBc	
0.5 Step Size Spurious Suppression	0.5 Step Size 125 kHz	-	-87	-70		
Reference Spurious Suppression	Ref. Freq. 60 MHz	-	-90	-75		
Comparison Spurious Suppression	Comp. Freq. 30 MHz	-	-90	-70		
Non - Harmonic Spurious Suppression	-	-	-90	-		
Harmonic Suppression	-	-	-20	-13	dBc	
VCO Supply Voltage	+5.00	4.75	5.00	5.25	V	
PLL Supply Voltage	+3.30	3.15	3.30	3.45		
VCO Supply Current	-	-	26	35	mA	
PLL Supply Current	-	-	17	25		
Reference Input (External)	Frequency	60 (square wave)	-	60	-	MHz
	Amplitude	1	-	1	-	V _{P-P}
	Input impedance	-	-	100	-	KΩ
	Phase Noise @ 1 kHz offset	-	-	-135	-	dBc/Hz
RF Output port Impedance	-	-	50	-	Ω	
Input Logic Level	Input high voltage	-	2.80	-	-	V
	Input low voltage	-	-	-	0.60	V
Digital Lock Detect	Locked	-	2.75	-	3.45	V
	Unlocked	-	-	-	0.40	V
Frequency Synthesizer PLL	-	ADF4153				
PLL Programming	-	3-wire serial 3.3V CMOS				
Register Map @ 1582.5 MHz	R0_Register	-	(MSB) 1101000000101101000 (LSB)			
	R1_Register	-	(MSB) 100001000000111100001 (LSB)			
	R2_Register	-	(MSB) 1111100010 (LSB)			
	R3_Register	-	(MSB) 1111000111 (LSB)			

Absolute Maximum Ratings

Parameters	Ratings
VCO Supply Voltage	5.8V
PLL Supply Voltage	4.0V
VCO Supply Voltage to PLL Supply Voltage	-0.3V to +5.8V
Reference Frequency Voltage	-0.3Vmin, VCC PLL +0.3Vmax
Data, Clock, LE Levels	-0.3Vmin, VCC PLL +0.3Vmax
Operating Temperature	-40°C to +85°C
Storage Temperature	-55°C to +100°C

Permanent damage may occur if any of these limits are exceeded



IF/RF MICROWAVE COMPONENTS • ISO 9001 ISO 14001 AS9100 CERTIFIED RoHS compliant
 P.O. Box 350166, Brooklyn, New York 11235-0003 (718) 934-4500 Fax (718) 332-4661

The Design Engineers Search Engine finds the model you need, Instantly • For detailed performance specs & shopping online see minicircuits.com

Notes: 1. Performance and quality attributes and conditions not expressly stated in this specification sheet are intended to be excluded and do not form a part of this specification sheet. 2. Electrical specifications and performance data contained herein are based on Mini-Circuit's applicable established test performance criteria and measurement instructions. 3. The parts covered by this specification sheet are subject to Mini-Circuits standard limited warranty and terms and conditions (collectively, "Standard Terms"); Purchasers of this part are entitled to the rights and benefits contained therein. For a full statement of the Standard Terms and the exclusive rights and remedies thereunder, please visit Mini-Circuits' website at www.minicircuits.com/MCLStore/terms.jsp.

Typical Performance Data

FREQUENCY (MHz)	POWER OUTPUT (dBm)			VCO CURRENT (mA)			PLL CURENT (mA)		
	-45°C	+25°C	+85°C	-45°C	+25°C	+85°C	-45°C	+25°C	+85°C
	1567.5	1.62	1.76	1.72	25.70	26.09	27.05	15.52	17.06
1569.0	1.61	1.76	1.72	25.71	26.09	27.05	15.49	16.82	19.02
1570.5	1.60	1.75	1.72	25.72	26.09	27.05	15.45	16.58	18.90
1572.0	1.60	1.75	1.72	25.72	26.10	27.06	15.53	17.08	19.62
1573.5	1.59	1.74	1.72	25.73	26.10	27.06	15.66	17.22	19.77
1575.0	1.59	1.74	1.72	25.73	26.11	27.07	15.75	17.32	19.50
1576.5	1.59	1.74	1.72	25.74	26.12	27.08	15.73	17.31	19.49
1578.0	1.58	1.74	1.72	25.75	26.12	27.09	15.72	17.30	19.50
1579.5	1.58	1.74	1.72	25.75	26.13	27.09	15.73	17.31	19.56
1581.0	1.58	1.74	1.72	25.76	26.14	27.10	15.74	17.32	19.57
1582.5	1.58	1.74	1.72	25.76	26.15	27.11	15.53	17.10	19.40

FREQUENCY (MHz)	HARMONICS (dBc)					
	F2			F3		
	-45°C	+25°C	+85°C	-45°C	+25°C	+85°C
1567.5	-17.09	-20.21	-22.98	-40.00	-43.89	-44.13
1569.0	-17.13	-20.31	-23.00	-40.39	-44.05	-45.02
1570.5	-17.18	-20.32	-23.00	-40.79	-44.31	-44.99
1572.0	-17.19	-20.31	-23.01	-41.07	-44.52	-44.91
1573.5	-17.19	-20.30	-23.03	-41.31	-44.65	-44.72
1575.0	-17.21	-20.28	-23.04	-41.45	-44.77	-44.54
1576.5	-17.25	-20.29	-23.01	-41.43	-44.64	-44.89
1578.0	-17.30	-20.30	-22.99	-41.40	-44.50	-45.24
1579.5	-17.37	-20.35	-23.00	-41.49	-44.73	-45.30
1581.0	-17.45	-20.42	-23.04	-41.58	-45.13	-45.20
1582.5	-17.51	-20.45	-23.04	-41.76	-45.77	-45.88



IF/RF MICROWAVE COMPONENTS • ISO 9001 ISO 14001 AS9100 CERTIFIED RoHS compliant
 P.O. Box 350166, Brooklyn, New York 11235-0003 (718) 934-4500 Fax (718) 332-4661



The Design Engineers Search Engine finds the model you need, Instantly • For detailed performance specs & shopping online see



Notes: 1. Performance and quality attributes and conditions not expressly stated in this specification sheet are intended to be excluded and do not form a part of this specification sheet. 2. Electrical specifications and performance data contained herein are based on Mini-Circuit's applicable established test performance criteria and measurement instructions. 3. The parts covered by this specification sheet are subject to Mini-Circuits standard limited warranty and terms and conditions (collectively, "Standard Terms"); Purchasers of this part are entitled to the rights and benefits contained therein. For a full statement of the Standard Terms and the exclusive rights and remedies thereunder, please visit Mini-Circuits' website at www.minicircuits.com/MCLStore/terms.jsp.

FREQUENCY (MHz)	PHASE NOISE (dBc/Hz) @ OFFSETS				
	+25°C				
	100Hz	1kHz	10kHz	100kHz	1MHz
1567.5	-86.64	-94.21	-109.25	-135.21	-154.01
1569.0	-87.21	-94.71	-108.60	-134.87	-154.79
1570.5	-86.77	-94.45	-108.88	-135.00	-154.85
1572.0	-86.29	-94.35	-109.00	-135.15	-154.78
1573.5	-85.73	-94.54	-108.78	-135.38	-154.47
1575.0	-85.18	-94.74	-108.57	-135.60	-154.16
1576.5	-85.07	-95.31	-108.80	-135.25	-154.25
1578.0	-84.97	-95.89	-109.02	-134.90	-154.35
1579.5	-85.37	-95.67	-109.15	-134.84	-154.59
1581.0	-86.04	-95.07	-109.21	-134.94	-154.90
1582.5	-87.88	-94.28	-109.02	-135.59	-154.64

FREQUENCY (MHz)	PHASE NOISE (dBc/Hz) @ OFFSETS				
	-45°C				
	100Hz	1kHz	10kHz	100kHz	1MHz
1567.5	-87.63	-95.60	-107.86	-135.29	-155.10
1569.0	-86.88	-95.78	-108.13	-135.35	-153.88
1570.5	-86.13	-95.96	-108.39	-135.41	-152.67
1572.0	-86.03	-96.25	-108.33	-135.48	-152.45
1573.5	-86.26	-96.59	-108.09	-135.55	-152.75
1575.0	-86.26	-96.77	-108.02	-135.51	-152.94
1576.5	-85.81	-96.63	-108.25	-135.25	-152.92
1578.0	-85.36	-96.48	-108.48	-134.98	-152.91
1579.5	-85.82	-96.89	-108.71	-135.18	-153.19
1581.0	-86.28	-97.30	-108.93	-135.38	-153.48
1582.5	-88.62	-96.28	-108.18	-135.67	-155.51

FREQUENCY (MHz)	PHASE NOISE (dBc/Hz) @ OFFSETS				
	+85°C				
	100Hz	1kHz	10kHz	100kHz	1MHz
1567.5	-86.45	-96.83	-108.39	-133.62	-154.14
1569.0	-85.29	-96.45	-108.12	-133.72	-153.98
1570.5	-84.86	-96.55	-108.07	-133.57	-153.83
1572.0	-84.88	-96.64	-108.05	-133.50	-153.81
1573.5	-85.76	-96.74	-108.09	-133.58	-154.06
1575.0	-86.65	-96.83	-108.12	-133.66	-154.32
1576.5	-87.43	-96.60	-108.22	-133.66	-154.47
1578.0	-88.21	-96.37	-108.32	-133.66	-154.63
1579.5	-87.77	-96.21	-108.51	-133.77	-154.70
1581.0	-86.71	-96.10	-108.76	-133.92	-154.74
1582.5	-89.21	-96.49	-108.72	-133.85	-154.49



IF/RF MICROWAVE COMPONENTS • ISO 9001 ISO 14001 AS9100 CERTIFIED RoHS compliant
 P.O. Box 350166, Brooklyn, New York 11235-0003 (718) 934-4500 Fax (718) 332-4661



The Design Engineers Search Engine finds the model you need, Instantly • For detailed performance specs & shopping online see



Notes: 1. Performance and quality attributes and conditions not expressly stated in this specification sheet are intended to be excluded and do not form a part of this specification sheet. 2. Electrical specifications and performance data contained herein are based on Mini-Circuit's applicable established test performance criteria and measurement instructions. 3. The parts covered by this specification sheet are subject to Mini-Circuits standard limited warranty and terms and conditions (collectively, "Standard Terms"); Purchasers of this part are entitled to the rights and benefits contained therein. For a full statement of the Standard Terms and the exclusive rights and remedies thereunder, please visit Mini-Circuits' website at www.minicircuits.com/MCLStore/terms.jsp.

COMPARISON SPURIOUS ORDER	COMPARISON SPURIOUS @Fcarrier 1567.5MHz+(n*Fcomparison) (dBc) note 1			COMPARISON SPURIOUS @Fcarrier 1575MHz+(n*Fcomparison) (dBc) note 1			COMPARISON SPURIOUS @Fcarrier 1582.5MHz+(n*Fcomparison) (dBc) note 1		
	n	-45°C	+25°C	+85°C	-45°C	+25°C	+85°C	-45°C	+25°C
-5	-90.97	-97.23	-88.30	-90.97	-95.90	-89.03	-92.92	-97.55	-89.45
-4	-83.19	-84.17	-89.16	-89.85	-105.99	-90.97	-89.54	-101.14	-91.78
-3	-90.81	-88.26	-92.97	-90.71	-87.51	-93.36	-88.01	-86.65	-95.05
-2	-83.76	-97.35	-89.83	-84.04	-96.69	-88.96	-83.55	-95.51	-90.28
-1	-88.06	-91.57	-93.46	-88.53	-90.92	-92.98	-87.19	-90.14	-92.38
0 note 2	-	-	-	-	-	-	-	-	-
+1	-84.40	-99.13	-94.87	-86.25	-97.00	-94.03	-87.57	-95.86	-93.10
+2	-88.67	-97.66	-87.17	-90.06	-91.77	-87.08	-92.81	-93.50	-87.82
+3	-86.72	-97.36	-94.53	-89.12	-96.87	-93.64	-92.25	-97.39	-92.98
+4	-79.15	-81.53	-85.83	-86.64	-100.71	-89.35	-88.82	-93.36	-91.21
+5	-88.36	-101.78	-91.79	-89.04	-104.20	-93.64	-89.43	-116.38	-94.68

Note 1: Comparison frequency 30 MHz
 Note 2: All spurs are referenced to carrier signal (n=0).

REFERENCE SPURIOUS ORDER	REFERENCE SPURIOUS @Fcarrier 1567.5MHz+(n*Freference) (dBc) note 3			REFERENCE SPURIOUS @Fcarrier 1575MHz+(n*Freference) (dBc) note 3			REFERENCE SPURIOUS @Fcarrier 1582.5MHz+(n*Freference) (dBc) note 3		
	n	-45°C	+25°C	+85°C	-45°C	+25°C	+85°C	-45°C	+25°C
-5	-93.15	-88.88	-99.86	-96.96	-90.03	-100.09	-92.95	-88.83	-103.00
-4	-85.93	-89.99	-100.59	-89.07	-91.22	-97.49	-88.61	-91.27	-95.42
-3	-82.21	-95.12	-100.45	-84.85	-94.50	-102.05	-85.97	-93.67	-99.00
-2	-90.74	-84.07	-88.80	-90.25	-106.42	-90.50	-90.36	-100.64	-91.08
-1	-81.27	-97.35	-88.97	-84.09	-96.77	-87.89	-83.47	-96.11	-89.19
0 note 4	-	-	-	-	-	-	-	-	-
+1	-85.48	-97.46	-87.02	-90.04	-91.78	-86.63	-92.89	-93.60	-87.35
+2	-82.98	-81.51	-86.07	-86.76	-100.92	-89.30	-88.88	-93.19	-90.44
+3	-90.30	-85.34	-97.04	-94.96	-87.08	-97.68	-95.95	-89.08	-97.38
+4	-94.22	-101.97	-102.81	-90.67	-98.32	-100.45	-89.74	-98.50	-98.78
+5	-90.36	-100.54	-109.16	-90.68	-99.73	-109.68	-89.59	-97.12	-109.43

Note 3: Reference frequency 60 MHz
 Note 4: All spurs are referenced to carrier signal (n=0).



IF/RF MICROWAVE COMPONENTS • ISO 9001 ISO 14001 AS9100 CERTIFIED RoHS compliant
 P.O. Box 350166, Brooklyn, New York 11235-0003 (718) 934-4500 Fax (718) 332-4661
 The Design Engineers Search Engine finds the model you need, Instantly • For detailed performance specs & shopping online see minicircuits.com

Notes: 1. Performance and quality attributes and conditions not expressly stated in this specification sheet are intended to be excluded and do not form a part of this specification sheet. 2. Electrical specifications and performance data contained herein are based on Mini-Circuit's applicable established test performance criteria and measurement instructions. 3. The parts covered by this specification sheet are subject to Mini-Circuits standard limited warranty and terms and conditions (collectively, "Standard Terms"); Purchasers of this part are entitled to the rights and benefits contained therein. For a full statement of the Standard Terms and the exclusive rights and remedies thereunder, please visit Mini-Circuits' website at www.minicircuits.com/MCLStore/terms.jsp.

STEP SIZE SPURIOUS ORDER n	0.5 STEP SIZE & STEP SIZE SPURIOUS @Fcarrier 1567.5MHz+(n*Fstep size) (dBc) note 5			0.5 STEP SIZE & STEP SIZE SPURIOUS @Fcarrier 1575MHz+(n*Fstep size) (dBc) note 5			0.5 STEP SIZE & STEP SIZE SPURIOUS @Fcarrier 1582.5MHz+(n*Fstep size) (dBc) note 5		
	-45°C	+25°C	+85°C	-45°C	+25°C	+85°C	-45°C	+25°C	+85°C
-5.0	-120.10	-117.13	-117.14	-107.14	-104.42	-117.21	-109.82	-112.51	-113.96
-4.5	-105.85	-107.98	-118.55	-105.17	-104.54	-119.03	-108.57	-109.86	-117.42
-4.0	-113.82	-111.31	-117.53	-102.08	-102.88	-116.28	-118.17	-111.18	-118.82
-3.5	-105.96	-101.52	-116.90	-99.95	-101.54	-115.70	-103.61	-117.06	-114.68
-3.0	-106.86	-104.43	-110.58	-107.70	-110.88	-112.50	-102.24	-110.76	-113.45
-2.5	-94.87	-100.78	-111.53	-101.19	-94.64	-109.47	-99.89	-108.57	-114.10
-2.0	-104.98	-113.60	-111.15	-103.47	-105.95	-108.77	-101.96	-112.23	-106.66
-1.5	-94.46	-107.07	-104.85	-96.06	-88.78	-106.70	-101.13	-100.88	-108.15
-1.0	-100.29	-94.11	-101.02	-101.92	-97.80	-97.26	-96.92	-95.78	-95.81
-0.5	-85.14	-84.78	-86.00	-79.53	-86.89	-87.97	-86.43	-85.14	-89.79
0 note 6	-	-	-	-	-	-	-	-	-
+0.5	-86.86	-89.50	-86.47	-75.81	-83.61	-85.41	-84.89	-84.61	-86.96
+1.0	-89.84	-96.19	-99.36	-100.13	-98.09	-99.11	-99.99	-97.57	-102.02
+1.5	-93.79	-107.45	-103.57	-100.89	-88.68	-99.01	-107.17	-103.07	-107.77
+2.0	-112.62	-106.92	-110.43	-102.34	-107.02	-104.17	-110.82	-111.91	-112.26
+2.5	-98.78	-101.16	-106.92	-105.26	-94.65	-105.76	-94.83	-109.66	-111.04
+3.0	-116.85	-105.03	-109.17	-114.71	-111.39	-116.87	-105.07	-104.61	-113.25
+3.5	-102.82	-102.25	-113.46	-101.62	-100.31	-110.01	-104.64	-112.64	-113.51
+4.0	-109.43	-118.65	-110.92	-112.39	-102.62	-112.88	-115.85	-109.52	-115.06
+4.5	-118.65	-111.51	-111.98	-106.47	-105.77	-113.27	-107.92	-109.06	-112.67
+5.0	-114.63	-108.14	-117.00	-108.23	-105.08	-107.29	-107.50	-117.18	-121.72

Note 5: Step size 250 kHz

Note 6: All spurs are referenced to carrier signal (n=0).



IF/RF MICROWAVE COMPONENTS • ISO 9001 ISO 14001 AS9100 CERTIFIED RoHS compliant
 P.O. Box 350166, Brooklyn, New York 11235-0003 (718) 934-4500 Fax (718) 332-4661



The Design Engineers Search Engine finds the model you need, Instantly • For detailed performance specs & shopping online see



Notes: 1. Performance and quality attributes and conditions not expressly stated in this specification sheet are intended to be excluded and do not form a part of this specification sheet. 2. Electrical specifications and performance data contained herein are based on Mini-Circuit's applicable established test performance criteria and measurement instructions. 3. The parts covered by this specification sheet are subject to Mini-Circuits standard limited warranty and terms and conditions (collectively, "Standard Terms"); Purchasers of this part are entitled to the rights and benefits contained therein. For a full statement of the Standard Terms and the exclusive rights and remedies thereunder, please visit Mini-Circuits' website at www.minicircuits.com/MCLStore/terms.jsp.

Typical Performance Curves

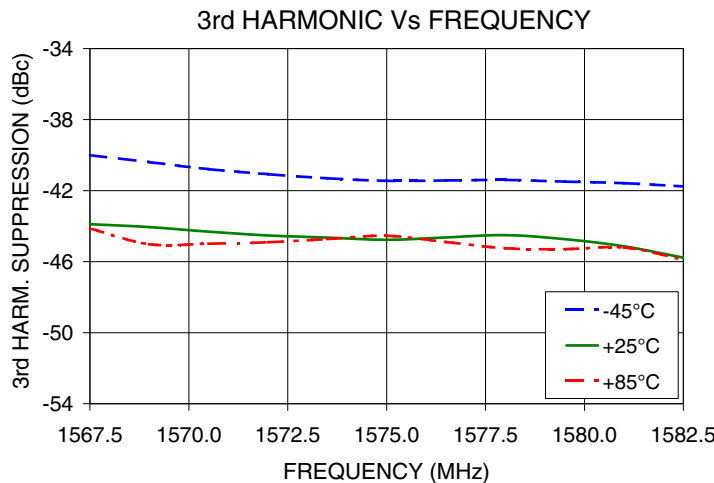
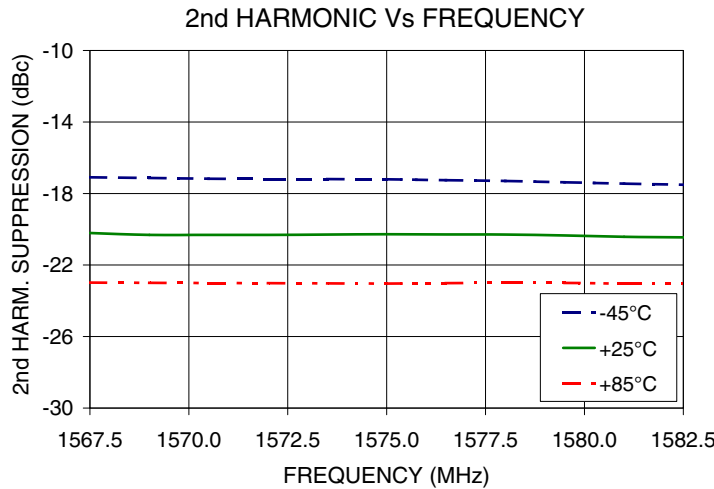
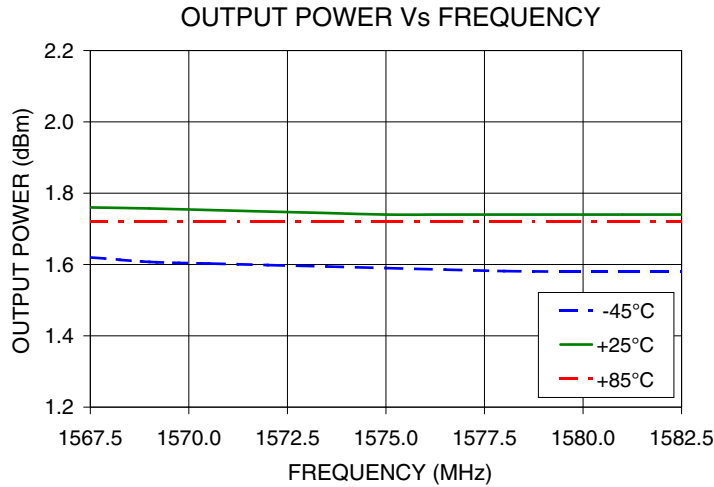

IF/RF MICROWAVE COMPONENTS • ISO 9001 ISO 14001 AS9100 CERTIFIED RoHS compliant
 P.O. Box 350166, Brooklyn, New York 11235-0003 (718) 934-4500 Fax (718) 332-4661



The Design Engineers Search Engine finds the model you need, Instantly • For detailed performance specs & shopping online see



Notes: 1. Performance and quality attributes and conditions not expressly stated in this specification sheet are intended to be excluded and do not form a part of this specification sheet. 2. Electrical specifications and performance data contained herein are based on Mini-Circuit's applicable established test performance criteria and measurement instructions. 3. The parts covered by this specification sheet are subject to Mini-Circuits standard limited warranty and terms and conditions (collectively, "Standard Terms"); Purchasers of this part are entitled to the rights and benefits contained therein. For a full statement of the Standard Terms and the exclusive rights and remedies thereunder, please visit Mini-Circuits' website at www.minicircuits.com/MCLStore/terms.jsp.

PHASE NOISE @ 100Hz offset

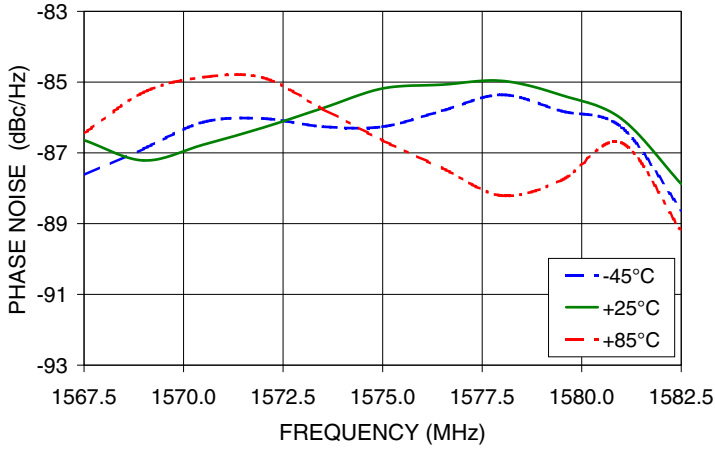

PHASE NOISE @ 1kHz offset

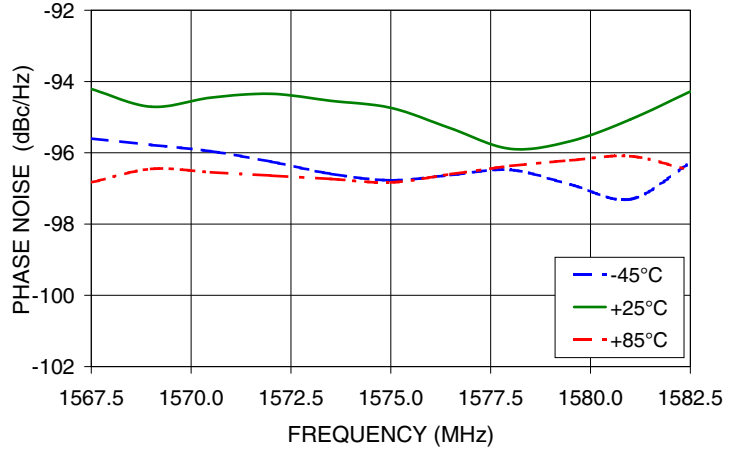

PHASE NOISE @ 10 kHz offset

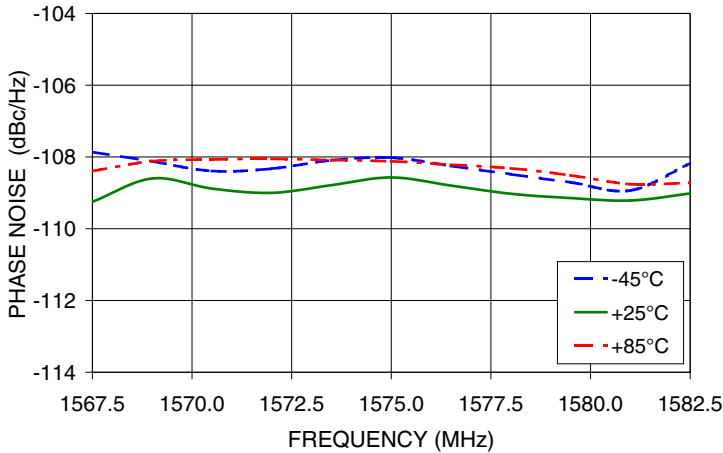

PHASE NOISE @ 100 kHz offset

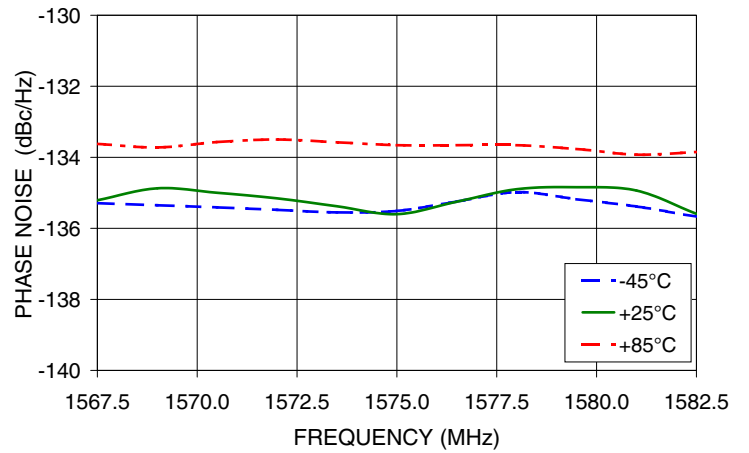

PHASE NOISE @ 1MHz offset

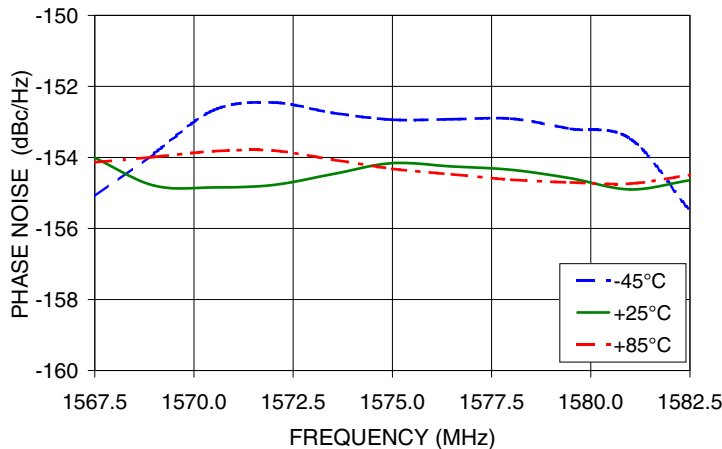

IF/RF MICROWAVE COMPONENTS • ISO 9001 ISO 14001 AS9100 CERTIFIED RoHS compliant
 P.O. Box 350166, Brooklyn, New York 11235-0003 (718) 934-4500 Fax (718) 332-4661



The Design Engineers Search Engine finds the model you need, Instantly • For detailed performance specs & shopping online see



Notes: 1. Performance and quality attributes and conditions not expressly stated in this specification sheet are intended to be excluded and do not form a part of this specification sheet. 2. Electrical specifications and performance data contained herein are based on Mini-Circuit's applicable established test performance criteria and measurement instructions. 3. The parts covered by this specification sheet are subject to Mini-Circuits standard limited warranty and terms and conditions (collectively, "Standard Terms"); Purchasers of this part are entitled to the rights and benefits contained therein. For a full statement of the Standard Terms and the exclusive rights and remedies thereunder, please visit Mini-Circuits' website at www.minicircuits.com/MCLStore/terms.jsp.

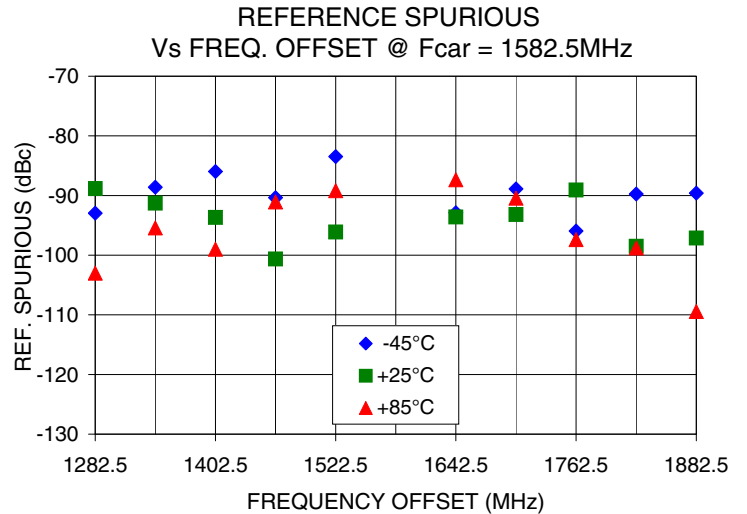
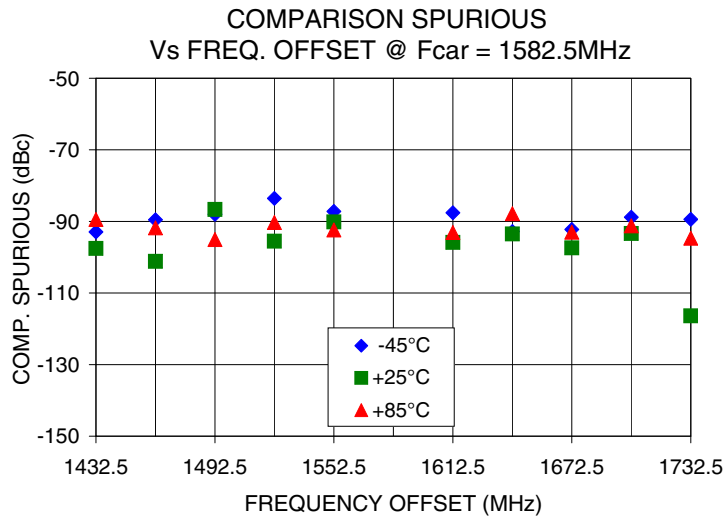
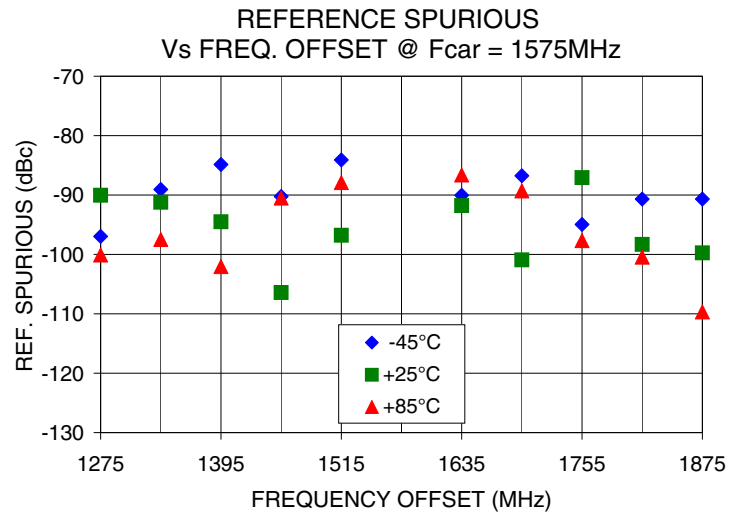
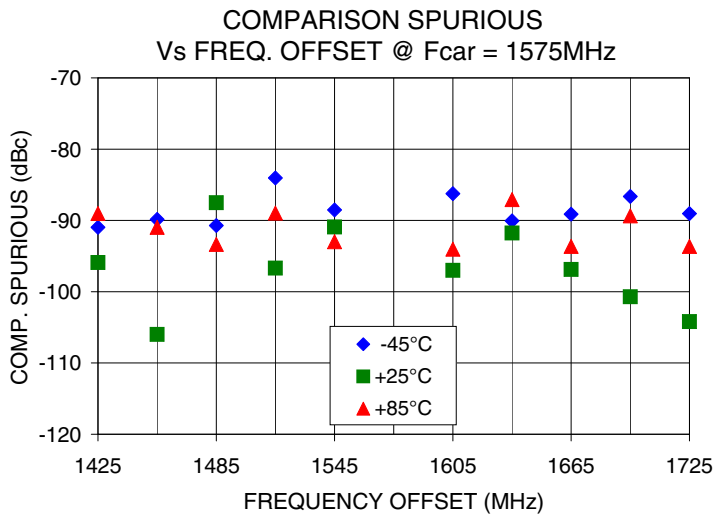
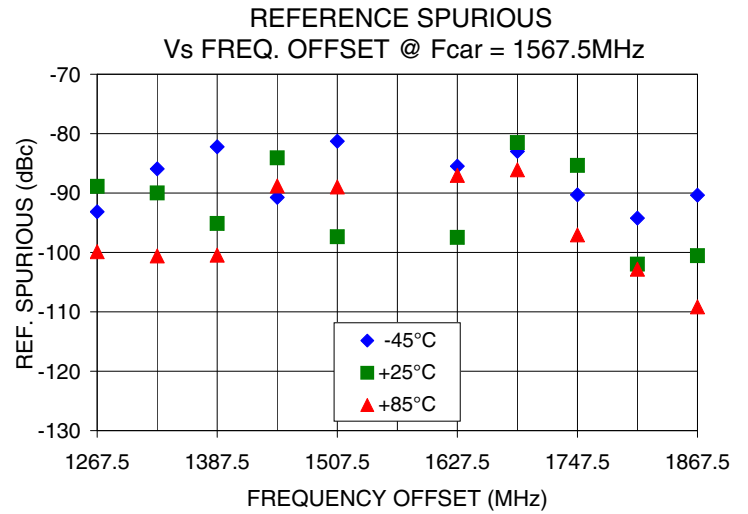
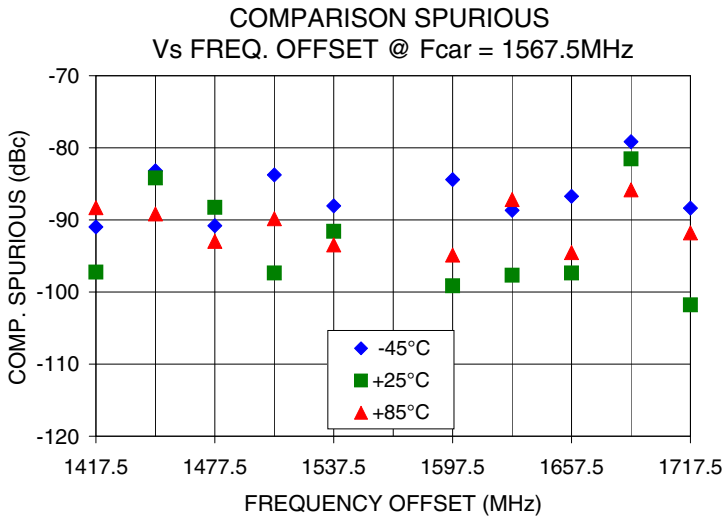

IF/RF MICROWAVE COMPONENTS • ISO 9001 ISO 14001 AS9100 CERTIFIED RoHS compliant
P.O. Box 350166, Brooklyn, New York 11235-0003 (718) 934-4500 Fax (718) 332-4661



The Design Engineers Search Engine finds the model you need, Instantly • For detailed performance specs & shopping online see



Notes: 1. Performance and quality attributes and conditions not expressly stated in this specification sheet are intended to be excluded and do not form a part of this specification sheet. 2. Electrical specifications and performance data contained herein are based on Mini-Circuit's applicable established test performance criteria and measurement instructions. 3. The parts covered by this specification sheet are subject to Mini-Circuits standard limited warranty and terms and conditions (collectively, "Standard Terms"); Purchasers of this part are entitled to the rights and benefits contained therein. For a full statement of the Standard Terms and the exclusive rights and remedies thereunder, please visit Mini-Circuits' website at www.minicircuits.com/MCLStore/terms.jsp.

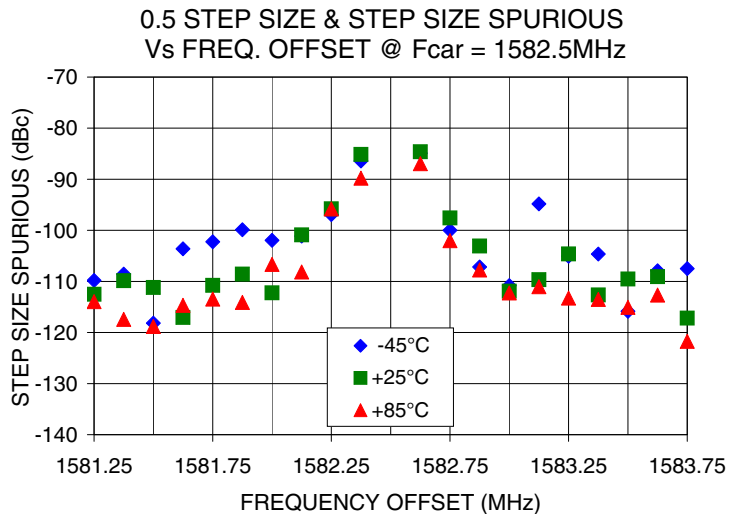
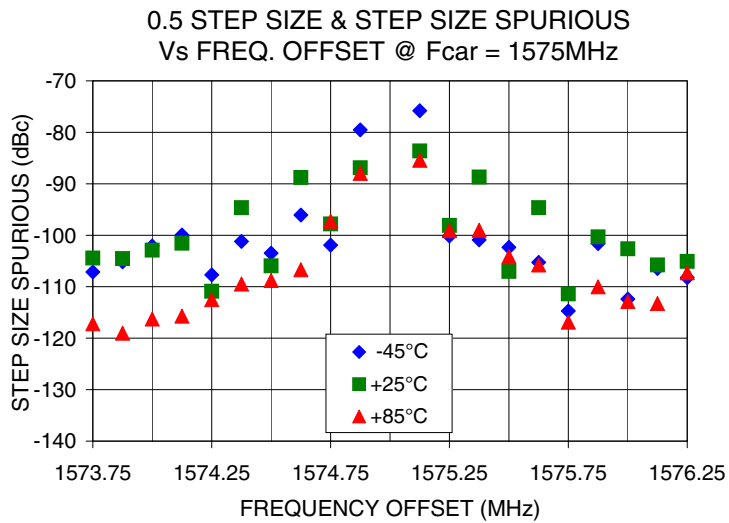
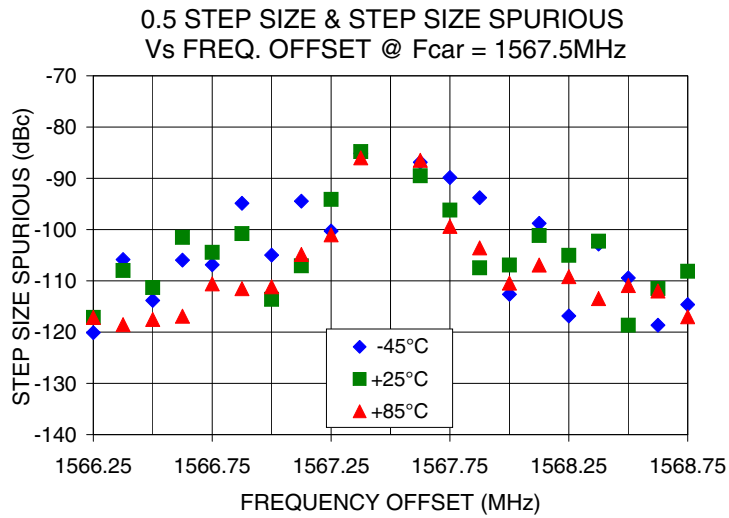

IF/RF MICROWAVE COMPONENTS • ISO 9001 ISO 14001 AS9100 CERTIFIED RoHS compliant
 P.O. Box 350166, Brooklyn, New York 11235-0003 (718) 934-4500 Fax (718) 332-4661



The Design Engineers Search Engine finds the model you need, Instantly • For detailed performance specs & shopping online see



Notes: 1. Performance and quality attributes and conditions not expressly stated in this specification sheet are intended to be excluded and do not form a part of this specification sheet. 2. Electrical specifications and performance data contained herein are based on Mini-Circuit's applicable established test performance criteria and measurement instructions. 3. The parts covered by this specification sheet are subject to Mini-Circuits standard limited warranty and terms and conditions (collectively, "Standard Terms"); Purchasers of this part are entitled to the rights and benefits contained therein. For a full statement of the Standard Terms and the exclusive rights and remedies thereunder, please visit Mini-Circuits' website at www.minicircuits.com/MCLStore/terms.jsp.

Pin Configuration

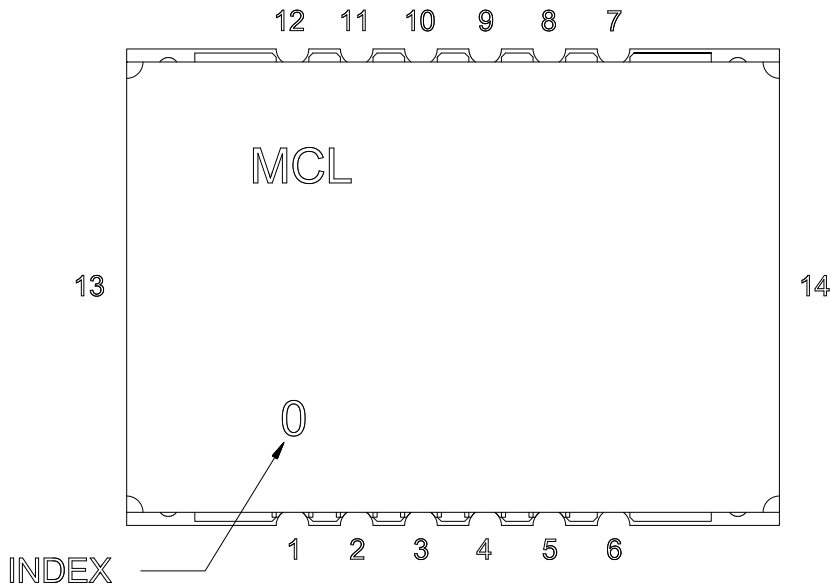

Pin Connection

Pin Number	Function
1	VCC PLL
2	GND
3	REF IN
4	GND
5	VCC VCO
6	GND
7	RF OUT
8	GND
9	LOCK DET
10	CLOCK
11	DATA
12	LE
13	GND
14	GND

Recommended Application Circuit

Note: REF IN and RF OUT ports are internally AC coupled.

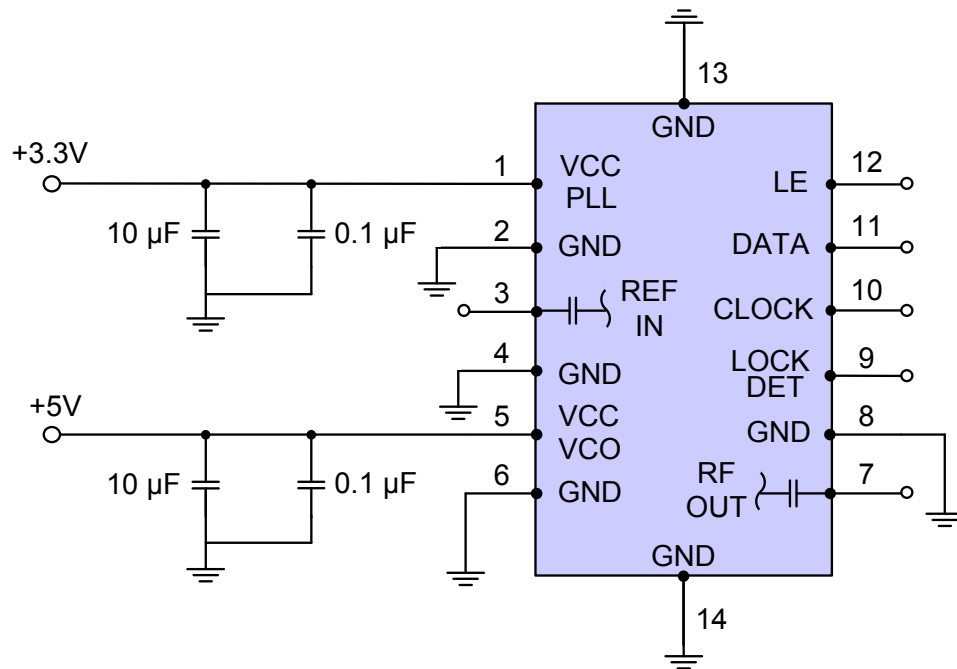

IF/RF MICROWAVE COMPONENTS • ISO 9001 ISO 14001 AS9100 CERTIFIED RoHS compliant
 P.O. Box 350166, Brooklyn, New York 11235-0003 (718) 934-4500 Fax (718) 332-4661



The Design Engineers Search Engine finds the model you need, Instantly • For detailed performance specs & shopping online see



Notes: 1. Performance and quality attributes and conditions not expressly stated in this specification sheet are intended to be excluded and do not form a part of this specification sheet. 2. Electrical specifications and performance data contained herein are based on Mini-Circuit's applicable established test performance criteria and measurement instructions. 3. The parts covered by this specification sheet are subject to Mini-Circuits standard limited warranty and terms and conditions (collectively, "Standard Terms"); Purchasers of this part are entitled to the rights and benefits contained therein. For a full statement of the Standard Terms and the exclusive rights and remedies thereunder, please visit Mini-Circuits' website at www.minicircuits.com/MCLStore/terms.jsp.

Device Marking

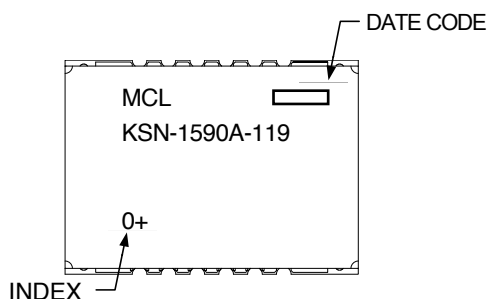

Additional Detailed Technical Information

Additional information is available on our web site. To access this information enter the model number on our web site home page.

Case Style: DK1171

Tape & Reel: TR-F28

Suggested Layout for PCB Design: PL-249

Evaluation Board: TB-567-1+

Environment Ratings: ENV03T2



IF/RF MICROWAVE COMPONENTS • ISO 9001 ISO 14001 AS9100 CERTIFIED RoHS compliant
P.O. Box 350166, Brooklyn, New York 11235-0003 (718) 934-4500 Fax (718) 332-4661



The Design Engineers Search Engine finds the model you need, Instantly • For detailed performance specs & shopping online see



Notes: 1. Performance and quality attributes and conditions not expressly stated in this specification sheet are intended to be excluded and do not form a part of this specification sheet. 2. Electrical specifications and performance data contained herein are based on Mini-Circuit's applicable established test performance criteria and measurement instructions. 3. The parts covered by this specification sheet are subject to Mini-Circuits standard limited warranty and terms and conditions (collectively, "Standard Terms"); Purchasers of this part are entitled to the rights and benefits contained therein. For a full statement of the Standard Terms and the exclusive rights and remedies thereunder, please visit Mini-Circuits' website at www.minicircuits.com/MCLStore/terms.jsp.