

# Frequency Synthesizer

KSN-1060A-219+

50Ω 1020 to 1055 MHz

## The Big Deal

- Low phase noise and spurious
- Robust design and construction
- Small size 0.80" x 0.58" x 0.15"



CASE STYLE: DK1042

## Product Overview

The KSN-1060A-219+ is a Frequency Synthesizer, designed to operate from 1020 to 1055 MHz for TV distribution / digital TV application. The KSN-1060A-219+ is packaged in a metal case (size of 0.80" x 0.58" x 0.15") to shield against unwanted signals and noise.

## Key Features

Feature	Advantages
Low phase noise and spurious: <ul style="list-style-type: none"><li>• Phase Noise: -114 dBc/Hz typ. @ 10 kHz offset</li><li>• Comparison Spurious: -82 dBc typ.</li><li>• Reference Spurious: -120 dBc typ.</li></ul>	Low phase noise and spurious improve system EVM (Error Vector Magnitude).
Robust design and construction	To enhance the robustness of KSN-1060A-219+, each internal component is secured to the substrate with chip bonder, thereby eliminating the risk of tombstoning during subsequent solder reflow operations by the customer.
Small size, 0.80" x 0.58" x 0.15"	The small size enables the KSN-1060A-219+ to be used in compact designs.



IF/RF MICROWAVE COMPONENTS • ISO 9001 ISO 14001 AS9100 CERTIFIED RoHS compliant  
P.O. Box 350166, Brooklyn, New York 11235-0003 (718) 934-4500 Fax (718) 332-4661



The Design Engineers Search Engine finds the model you need, Instantly • For detailed performance specs & shopping online see [minicircuits.com](http://minicircuits.com)

Notes: 1. Performance and quality attributes and conditions not expressly stated in this specification sheet are intended to be excluded and do not form a part of this specification sheet. 2. Electrical specifications and performance data contained herein are based on Mini-Circuit's applicable established test performance criteria and measurement instructions. 3. The parts covered by this specification sheet are subject to Mini-Circuits standard limited warranty and terms and conditions (collectively, "Standard Terms"); Purchasers of this part are entitled to the rights and benefits contained therein. For a full statement of the Standard Terms and the exclusive rights and remedies thereunder, please visit Mini-Circuits' website at [www.minicircuits.com/MCLStore/terms.jsp](http://www.minicircuits.com/MCLStore/terms.jsp).

50Ω 1020 to 1055 MHz

### Features

- Integrated VCO + PLL
- Low phase noise and spurious
- Robust design and construction
- Low operating voltage (VCC VCO=+5V, VCC PLL=+5V)
- Small size 0.80" x 0.58" x 0.15"



CASE STYLE: DK1042  
PRICE: \$29.95 ea. QTY (1-9)

+ RoHS compliant in accordance with EU Directive (2002/95/EC)

The +Suffix has been added in order to identify RoHS Compliance. See our web site for RoHS Compliance methodologies and qualifications.

### Applications

- TV distribution / digital TV

### General Description

The KSN-1060A-219+ is a Frequency Synthesizer, designed to operate from 1020 to 1055 MHz for TV distribution / digital TV application. The KSN-1060A-219+ is packaged in a metal case (size of 0.80" x 0.58" x 0.15") to shield against unwanted signals and noise. To enhance the robustness of KSN-1060A-219+, each internal component is secured to the substrate with chip bonder, thereby eliminating the risk of tombstoning during subsequent solder reflow operations by the customer.

### Simplified Schematic



IF/RF MICROWAVE COMPONENTS • ISO 9001 ISO 14001 AS9100 CERTIFIED RoHS compliant  
P.O. Box 350166, Brooklyn, New York 11235-0003 (718) 934-4500 Fax (718) 332-4661



The Design Engineers Search Engine finds the model you need, Instantly • For detailed performance specs & shopping online see



Notes: 1. Performance and quality attributes and conditions not expressly stated in this specification sheet are intended to be excluded and do not form a part of this specification sheet. 2. Electrical specifications and performance data contained herein are based on Mini-Circuit's applicable established test performance criteria and measurement instructions. 3. The parts covered by this specification sheet are subject to Mini-Circuits standard limited warranty and terms and conditions (collectively, "Standard Terms"); Purchasers of this part are entitled to the rights and benefits contained therein. For a full statement of the Standard Terms and the exclusive rights and remedies thereunder, please visit Mini-Circuits' website at [www.minicircuits.com/MCLStore/terms.jsp](http://www.minicircuits.com/MCLStore/terms.jsp).

**Electrical Specifications** (over operating temperature 0°C to +70°C)

Parameters	Test Conditions	Min.	Typ.	Max.	Units	
Frequency Range	-	1020	-	1055	MHz	
Step Size	-	-	12.5	-	kHz	
Settling Time	Within $\pm 1$ kHz	-	100	-	mSec	
Output Power	-	-3	0	+3	dBm	
SSB Phase Noise	@ 100 Hz offset	-	-50	-	dBc/Hz	
	@ 1 kHz offset	-	-87	-82		
	@ 10 kHz offset	-	-114	-109		
	@ 100 kHz offset	-	-134	-129		
	@ 1 MHz offset	-	-153	-139		
Reference Spurious Suppression	Ref. Freq. 13 MHz	-	-120	-90	dBc	
Comparison Spurious Suppression	Step Size 12.5 kHz	-	-82	-65		
Non - Harmonic Spurious Suppression	-	-	-90	-		
Harmonic Suppression	-	-	-27	-22		
VCO Supply Voltage	+5.00	+4.75	+5.00	+5.25		V
PLL Supply Voltage	+5.00	+4.75	+5.00	+5.25		
VCO Supply Current	-	-	31	38	mA	
PLL Supply Current	-	-	19	26		
Reference Input (External)	Frequency	13 (square wave)	-	13	-	MHz
	Amplitude	1	-	1	-	V <sub>P-P</sub>
	Input impedance	-	-	100	-	K $\Omega$
	Phase Noise @ 1 kHz offset	-	-	-130	-	dBc/Hz
RF Output port Impedance	-	-	50	-	$\Omega$	
Input Logic Level	Input high voltage	-	2.85	-	-	V
	Input low voltage	-	-	-	0.60	V
Digital Lock Detect	Locked	-	2.75	-	3.55	V
	Unlocked	-	-	-	0.40	V
Frequency Synthesizer PLL	-	ADF4113				
PLL Programming	-	3-wire serial 3.3V CMOS				
Register Map @ 1055 MHz	F_Register	-	(MSB) 01011111100000010010011 (LSB)			
	N_Register	-	(MSB) 001101001001101100000001 (LSB)			
	R_Register	-	(MSB) 000100000001000001000000 (LSB)			

**Absolute Maximum Ratings**

Parameters	Ratings
VCO Supply Voltage	6.3V
PLL Supply Voltage	6.3V
VCO Supply Voltage to PLL Supply Voltage	-0.3V to +5.5V
Reference Frequency Voltage	-0.3Vmin, +3.5Vmax
Data, Clock, LE Levels	-0.3Vmin, +3.5Vmax
Operating Temperature	-40°C to +85°C
Storage Temperature	-55°C to +100°C

Permanent damage may occur if any of these limits are exceeded



IF/RF MICROWAVE COMPONENTS • ISO 9001 ISO 14001 AS9100 CERTIFIED RoHS compliant  
P.O. Box 350166, Brooklyn, New York 11235-0003 (718) 934-4500 Fax (718) 332-4661

The Design Engineers Search Engine finds the model you need, Instantly • For detailed performance specs & shopping online see [minicircuits.com](http://minicircuits.com)

Notes: 1. Performance and quality attributes and conditions not expressly stated in this specification sheet are intended to be excluded and do not form a part of this specification sheet. 2. Electrical specifications and performance data contained herein are based on Mini-Circuit's applicable established test performance criteria and measurement instructions. 3. The parts covered by this specification sheet are subject to Mini-Circuits standard limited warranty and terms and conditions (collectively, "Standard Terms"); Purchasers of this part are entitled to the rights and benefits contained therein. For a full statement of the Standard Terms and the exclusive rights and remedies thereunder, please visit Mini-Circuits' website at [www.minicircuits.com/MCLStore/terms.jsp](http://www.minicircuits.com/MCLStore/terms.jsp).

Typical Performance Data

FREQUENCY (MHz)	POWER OUTPUT (dBm)			VCO CURRENT (mA)			PLL CURENT (mA)		
	-5°C	+25°C	+75°C	-5°C	+25°C	+75°C	-5°C	+25°C	+75°C
	1020.0	0.73	0.74	0.62	31.08	31.66	32.52	18.45	19.11
1024.5	0.63	0.64	0.53	31.07	31.65	32.51	18.46	19.12	20.26
1031.0	0.47	0.48	0.36	31.05	31.64	32.51	18.47	19.12	20.26
1037.5	0.30	0.32	0.20	31.03	31.62	32.50	18.47	19.13	20.27
1044.0	0.16	0.17	0.06	31.01	31.61	32.49	18.47	19.13	20.28
1050.5	0.03	0.04	-0.07	30.99	31.59	32.48	18.48	19.14	20.28
1055.0	-0.04	-0.04	-0.14	30.98	31.58	32.47	18.48	19.14	20.28

FREQUENCY (MHz)	HARMONICS (dBc)					
	F2			F3		
	-5°C	+25°C	+75°C	-5°C	+25°C	+75°C
1020.0	-26.66	-27.12	-27.24	-49.44	-50.11	-50.80
1024.5	-26.91	-27.38	-27.54	-50.46	-51.08	-51.72
1031.0	-27.02	-27.54	-27.69	-51.50	-52.40	-52.80
1037.5	-27.17	-27.67	-27.88	-49.58	-50.95	-51.54
1044.0	-27.38	-27.87	-28.07	-47.75	-48.39	-49.20
1050.5	-28.23	-28.76	-28.87	-49.43	-50.02	-50.18
1055.0	-28.92	-29.45	-29.81	-50.47	-51.10	-51.14

FREQUENCY (MHz)	PHASE NOISE (dBc/Hz) @OFFSETS				
	+25°C				
	100Hz	1kHz	10kHz	100kHz	1MHz
1020.0	-51.60	-89.21	-114.27	-135.33	-155.21
1024.5	-54.67	-87.31	-114.32	-135.29	-148.51
1031.0	-54.04	-88.91	-114.30	-135.30	-155.24
1037.5	-54.57	-89.18	-113.96	-135.09	-155.08
1044.0	-54.16	-88.24	-113.99	-134.40	-155.47
1050.5	-52.40	-88.55	-113.68	-134.31	-155.74
1055.0	-51.43	-86.96	-114.04	-133.63	-154.61

FREQUENCY (MHz)	PHASE NOISE (dBc/Hz) @OFFSETS				
	-5°C				
	100Hz	1kHz	10kHz	100kHz	1MHz
1020.0	-55.97	-87.47	-114.73	-136.10	-154.99
1024.5	-54.81	-88.33	-114.59	-135.97	-153.83
1031.0	-55.02	-87.18	-114.26	-135.85	-155.89
1037.5	-53.59	-87.24	-113.97	-135.48	-155.63
1044.0	-55.38	-87.39	-113.83	-134.97	-155.24
1050.5	-52.25	-86.15	-113.07	-134.22	-154.93
1055.0	-52.31	-85.06	-113.18	-133.37	-154.39

FREQUENCY (MHz)	PHASE NOISE (dBc/Hz) @OFFSETS				
	+75°C				
	100Hz	1kHz	10kHz	100kHz	1MHz
1020.0	-51.56	-88.35	-113.56	-133.95	-154.21
1024.5	-51.98	-89.73	-113.54	-134.02	-147.93
1031.0	-56.27	-89.47	-113.71	-134.31	-154.58
1037.5	-54.40	-88.32	-113.77	-134.55	-154.55
1044.0	-54.11	-88.01	-114.04	-134.83	-155.00
1050.5	-55.48	-88.79	-114.25	-135.03	-154.71
1055.0	-55.08	-87.68	-114.13	-134.91	-155.18



IF/RF MICROWAVE COMPONENTS • ISO 9001 ISO 14001 AS9100 CERTIFIED RoHS compliant  
 P.O. Box 350166, Brooklyn, New York 11235-0003 (718) 934-4500 Fax (718) 332-4661



The Design Engineers Search Engine finds the model you need, Instantly • For detailed performance specs & shopping online see



Notes: 1. Performance and quality attributes and conditions not expressly stated in this specification sheet are intended to be excluded and do not form a part of this specification sheet. 2. Electrical specifications and performance data contained herein are based on Mini-Circuit's applicable established test performance criteria and measurement instructions. 3. The parts covered by this specification sheet are subject to Mini-Circuits standard limited warranty and terms and conditions (collectively, "Standard Terms"); Purchasers of this part are entitled to the rights and benefits contained therein. For a full statement of the Standard Terms and the exclusive rights and remedies thereunder, please visit Mini-Circuits' website at [www.minicircuits.com/MCLStore/terms.jsp](http://www.minicircuits.com/MCLStore/terms.jsp).

COMPARISON SPURIOUS ORDER	COMPARISON SPURIOUS @ Fcarrier 1020MHz+(n*Fcomparison) (dBc) note 1			COMPARISON SPURIOUS @ Fcarrier 1037MHz+(n*Fcomparison) (dBc) note 1			COMPARISON SPURIOUS @ Fcarrier 1055MHz+(n*Fcomparison) (dBc) note 1		
	-5°C	+25°C	+75°C	-5°C	+25°C	+75°C	-5°C	+25°C	+75°C
	n								
-5	-104.71	-108.14	-103.63	-102.57	-104.94	-104.08	-97.97	-98.99	-102.83
-4	-101.64	-101.97	-99.70	-100.03	-101.49	-102.68	-94.23	-96.01	-101.70
-3	-97.08	-98.85	-98.87	-96.68	-96.82	-98.75	-89.63	-92.11	-99.61
-2	-91.10	-95.32	-94.64	-89.30	-92.40	-93.27	-85.18	-87.77	-92.46
-1	-82.04	-84.76	-85.71	-80.93	-81.09	-82.35	-75.43	-77.07	-80.80
0 note 2	-	-	-	-	-	-	-	-	-
+1	-80.46	-85.85	-86.71	-81.72	-83.68	-82.97	-75.24	-77.82	-81.24
+2	-90.28	-95.64	-94.94	-89.48	-91.72	-93.71	-84.46	-86.63	-91.50
+3	-94.53	-100.67	-99.33	-96.06	-97.34	-98.58	-90.12	-92.16	-95.80
+4	-100.45	-105.33	-101.14	-101.66	-102.95	-102.74	-94.97	-96.39	-99.34
+5	-104.31	-106.77	-104.12	-102.83	-104.80	-105.44	-98.20	-99.51	-102.45

Note 1: Comparison frequency 12.5 kHz

Note 2: All spurs are referenced to carrier signal (n=0).

REFERENCE SPURIOUS ORDER	REFERENCE SPURIOUS @ Fcarrier 1020MHz+(n*Freference) (dBc) note 3			REFERENCE SPURIOUS @ Fcarrier 1037MHz+(n*Freference) (dBc) note 3			REFERENCE SPURIOUS @ Fcarrier 1055MHz+(n*Freference) (dBc) note 3		
	-5°C	+25°C	+75°C	-5°C	+25°C	+75°C	-5°C	+25°C	+75°C
	n								
-5	-120.42	-122.82	-123.37	-121.86	-119.79	-122.03	-118.37	-120.77	-121.38
-4	-114.62	-114.49	-115.06	-113.88	-113.74	-113.10	-113.65	-113.45	-114.13
-3	-124.59	-127.72	-125.37	-126.40	-129.46	-123.90	-124.74	-123.48	-124.04
-2	-118.43	-119.51	-120.89	-116.97	-117.66	-118.93	-115.43	-115.64	-116.84
-1	-127.49	-128.79	-124.36	-120.16	-121.18	-119.46	-124.22	-121.83	-120.78
0 note 4	-	-	-	-	-	-	-	-	-
+1	-118.14	-115.85	-113.96	-116.41	-113.90	-113.79	-117.75	-115.13	-114.00
+2	-122.20	-121.98	-121.54	-119.92	-121.00	-121.93	-117.78	-119.44	-119.25
+3	-127.01	-127.88	-128.66	-125.90	-128.08	-124.72	-122.49	-127.61	-123.97
+4	-114.79	-115.25	-116.30	-113.74	-114.48	-114.43	-112.65	-113.17	-113.13
+5	-122.34	-126.16	-124.96	-119.90	-122.81	-120.82	-120.14	-122.41	-117.91

Note 3: Reference frequency 13 MHz

Note 4: All spurs are referenced to carrier signal (n=0).



IF/RF MICROWAVE COMPONENTS • ISO 9001 ISO 14001 AS9100 CERTIFIED RoHS compliant  
 P.O. Box 350166, Brooklyn, New York 11235-0003 (718) 934-4500 Fax (718) 332-4661



The Design Engineers Search Engine finds the model you need, Instantly • For detailed performance specs & shopping online see



Notes: 1. Performance and quality attributes and conditions not expressly stated in this specification sheet are intended to be excluded and do not form a part of this specification sheet. 2. Electrical specifications and performance data contained herein are based on Mini-Circuit's applicable established test performance criteria and measurement instructions. 3. The parts covered by this specification sheet are subject to Mini-Circuits standard limited warranty and terms and conditions (collectively, "Standard Terms"); Purchasers of this part are entitled to the rights and benefits contained therein. For a full statement of the Standard Terms and the exclusive rights and remedies thereunder, please visit Mini-Circuits' website at [www.minicircuits.com/MCLStore/terms.jsp](http://www.minicircuits.com/MCLStore/terms.jsp).

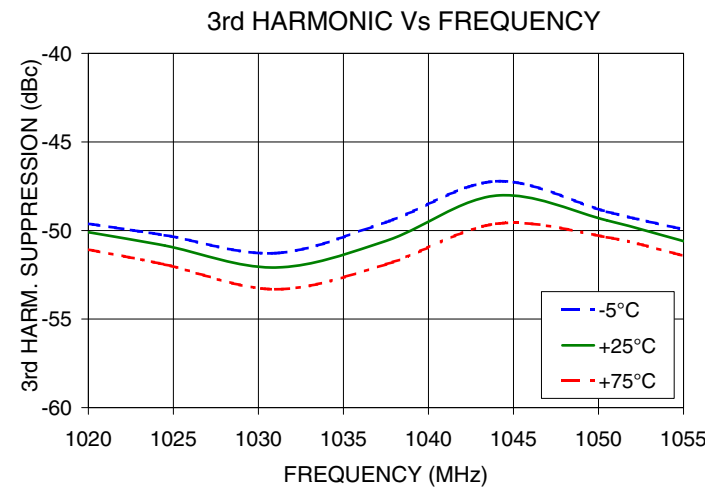
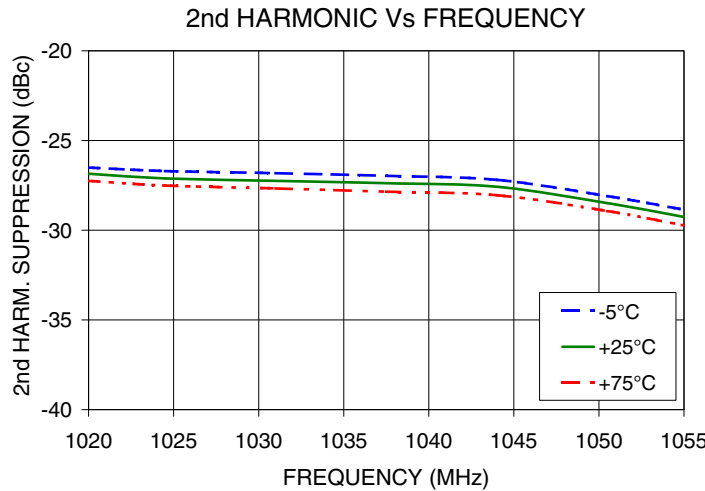
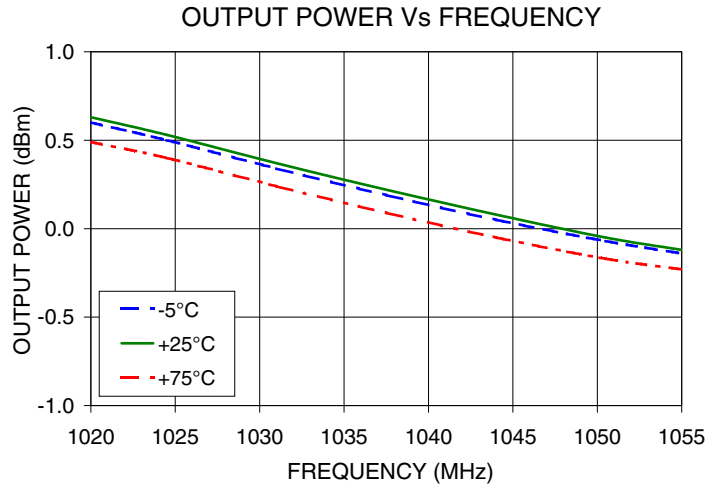

IF/RF MICROWAVE COMPONENTS • ISO 9001 ISO 14001 AS9100 CERTIFIED RoHS compliant  
 P.O. Box 350166, Brooklyn, New York 11235-0003 (718) 934-4500 Fax (718) 332-4661



The Design Engineers Search Engine finds the model you need, Instantly • For detailed performance specs & shopping online see



Notes: 1. Performance and quality attributes and conditions not expressly stated in this specification sheet are intended to be excluded and do not form a part of this specification sheet. 2. Electrical specifications and performance data contained herein are based on Mini-Circuit's applicable established test performance criteria and measurement instructions. 3. The parts covered by this specification sheet are subject to Mini-Circuits standard limited warranty and terms and conditions (collectively, "Standard Terms"); Purchasers of this part are entitled to the rights and benefits contained therein. For a full statement of the Standard Terms and the exclusive rights and remedies thereunder, please visit Mini-Circuits' website at [www.minicircuits.com/MCLStore/terms.jsp](http://www.minicircuits.com/MCLStore/terms.jsp).

PHASE NOISE @100Hz offset

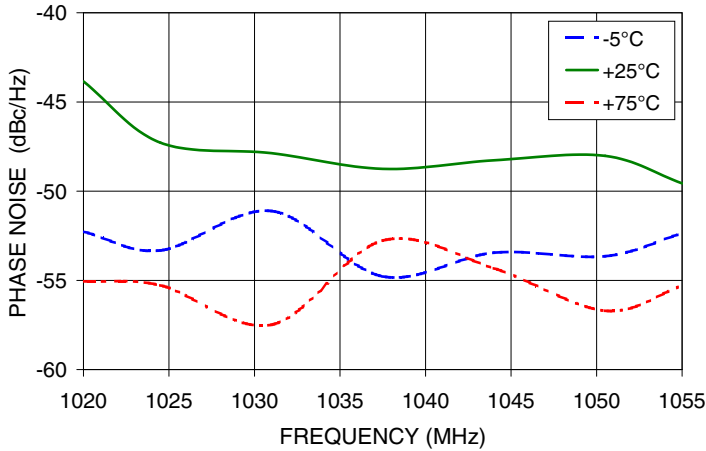

PHASE NOISE @ 1kHz offset

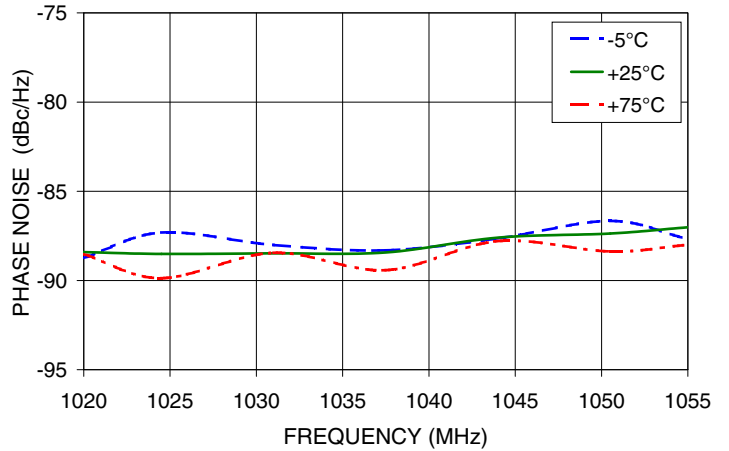

PHASE NOISE @ 10kHz offset

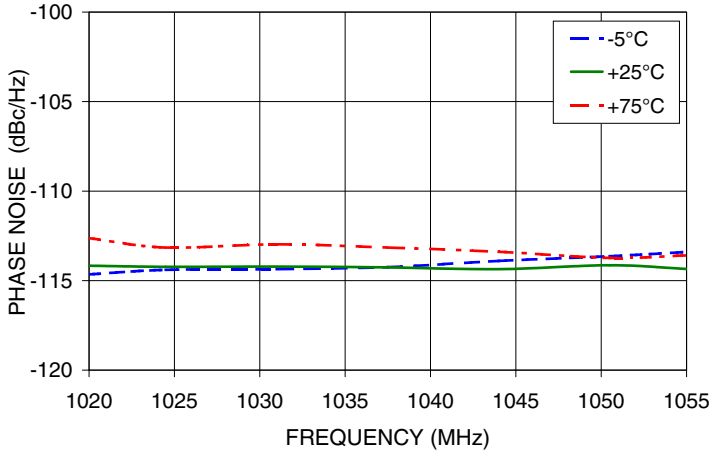

PHASE NOISE @ 100kHz offset

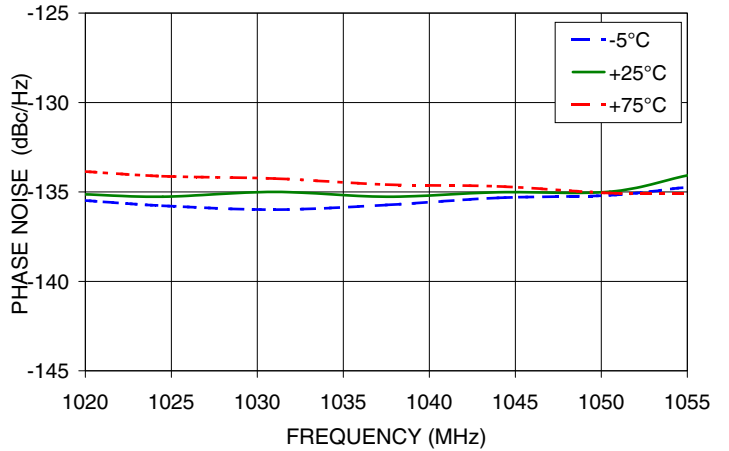

PHASE NOISE @ 1MHz offset

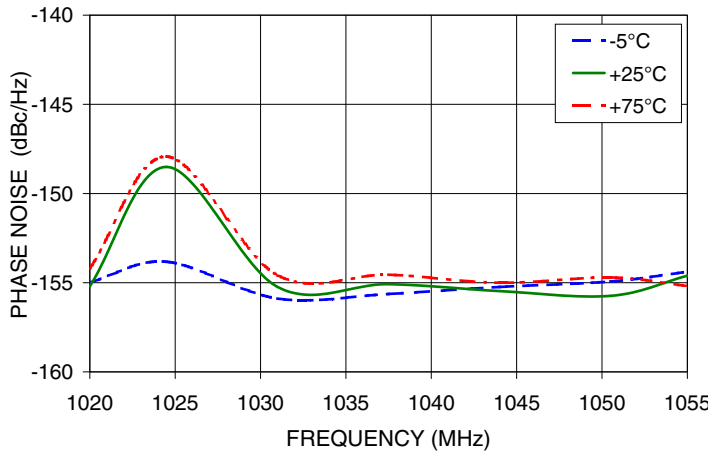

IF/RF MICROWAVE COMPONENTS • ISO 9001 ISO 14001 AS9100 CERTIFIED RoHS compliant  
 P.O. Box 350166, Brooklyn, New York 11235-0003 (718) 934-4500 Fax (718) 332-4661



The Design Engineers Search Engine finds the model you need, Instantly • For detailed performance specs & shopping online see



Notes: 1. Performance and quality attributes and conditions not expressly stated in this specification sheet are intended to be excluded and do not form a part of this specification sheet. 2. Electrical specifications and performance data contained herein are based on Mini-Circuit's applicable established test performance criteria and measurement instructions. 3. The parts covered by this specification sheet are subject to Mini-Circuits standard limited warranty and terms and conditions (collectively, "Standard Terms"); Purchasers of this part are entitled to the rights and benefits contained therein. For a full statement of the Standard Terms and the exclusive rights and remedies thereunder, please visit Mini-Circuits' website at [www.minicircuits.com/MCLStore/terms.jsp](http://www.minicircuits.com/MCLStore/terms.jsp).

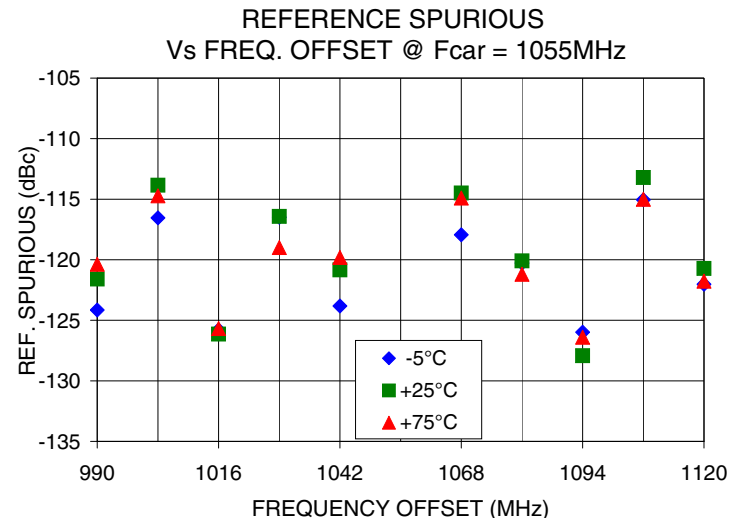
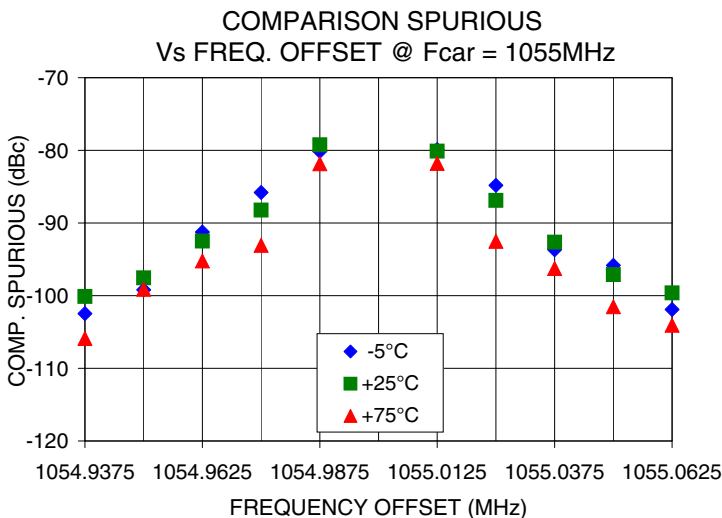
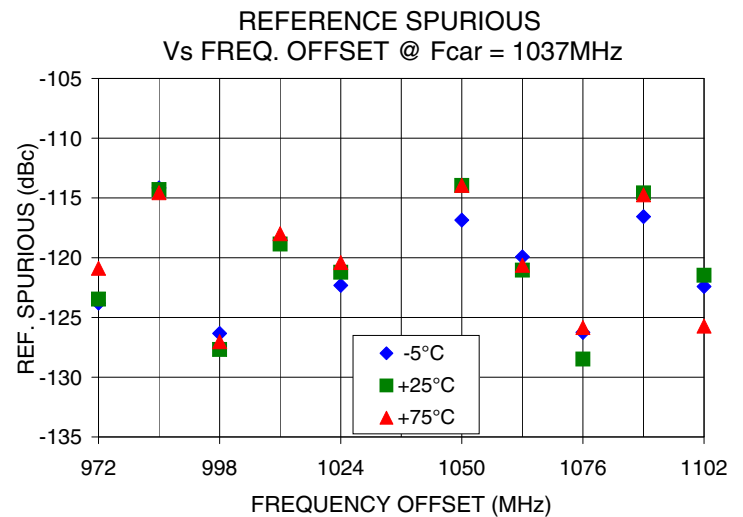
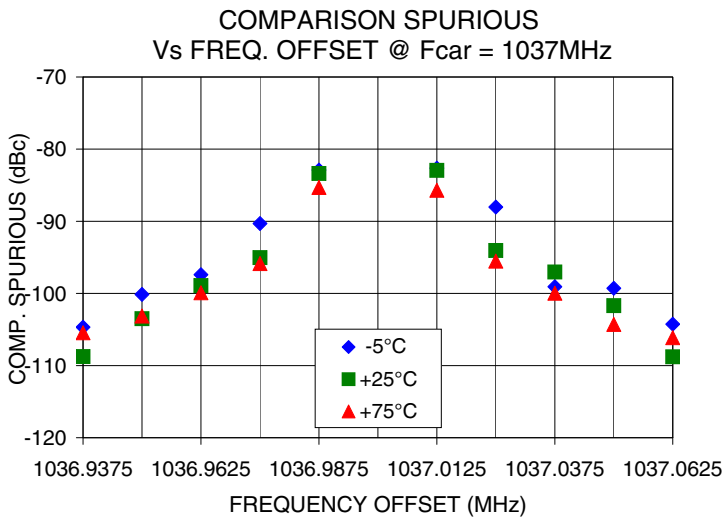
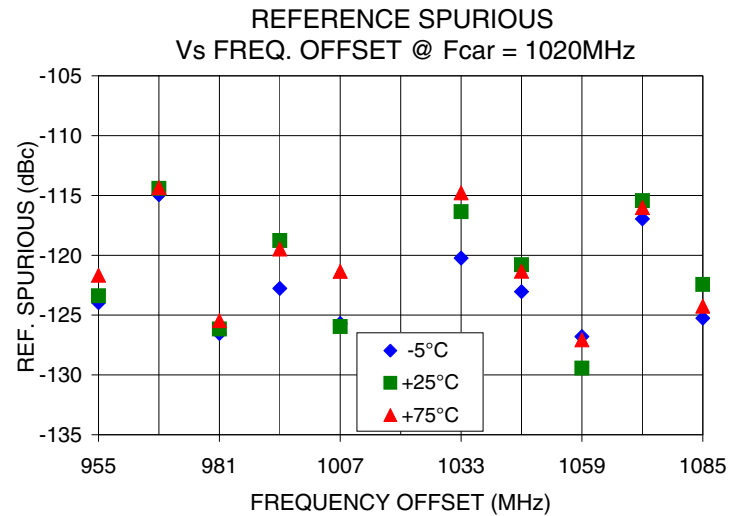
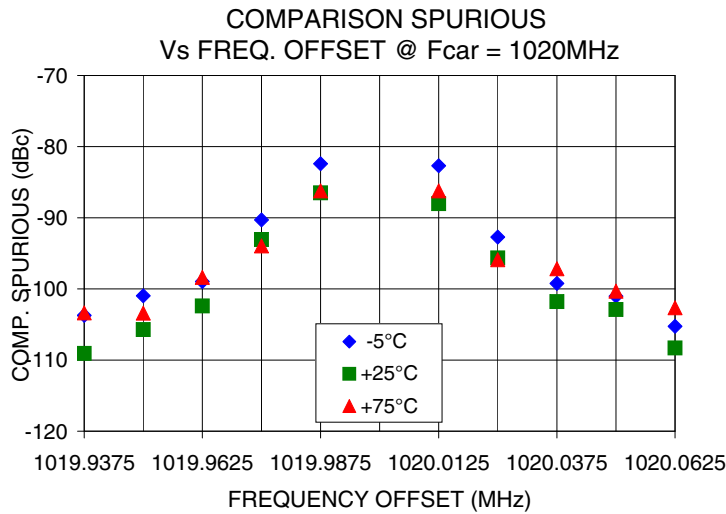

IF/RF MICROWAVE COMPONENTS • ISO 9001 ISO 14001 AS9100 CERTIFIED RoHS compliant  
P.O. Box 350166, Brooklyn, New York 11235-0003 (718) 934-4500 Fax (718) 332-4661



The Design Engineers Search Engine finds the model you need, Instantly • For detailed performance specs & shopping online see



Notes: 1. Performance and quality attributes and conditions not expressly stated in this specification sheet are intended to be excluded and do not form a part of this specification sheet. 2. Electrical specifications and performance data contained herein are based on Mini-Circuit's applicable established test performance criteria and measurement instructions. 3. The parts covered by this specification sheet are subject to Mini-Circuits standard limited warranty and terms and conditions (collectively, "Standard Terms"); Purchasers of this part are entitled to the rights and benefits contained therein. For a full statement of the Standard Terms and the exclusive rights and remedies thereunder, please visit Mini-Circuits' website at [www.minicircuits.com/MCLStore/terms.jsp](http://www.minicircuits.com/MCLStore/terms.jsp).

Pin Configuration

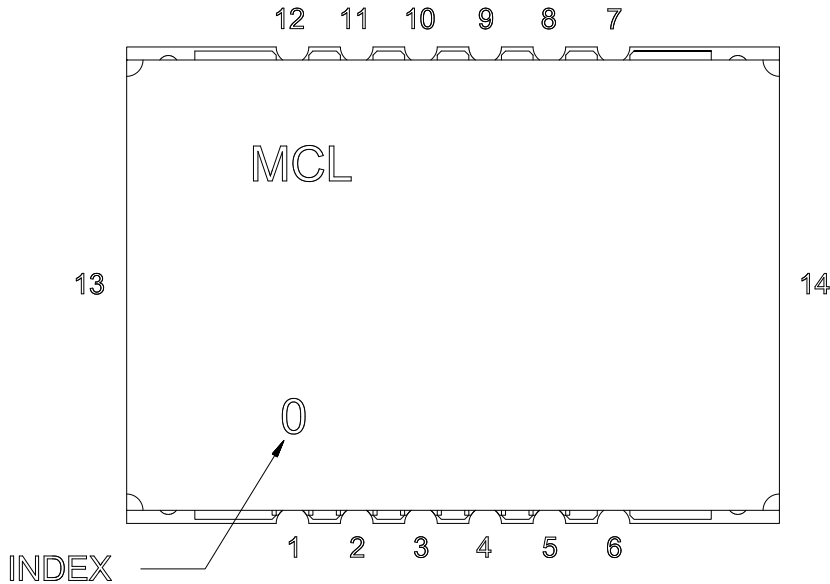

Pin Connection

Pin Number	Function
1	VCC PLL
2	GND
3	REF IN
4	GND
5	VCC VCO
6	GND
7	RF OUT
8	GND
9	LOCK DET
10	CLOCK
11	DATA
12	LE
13	GND
14	GND

Recommended Application Circuit

Note: REF IN and RF OUT ports are internally AC coupled.

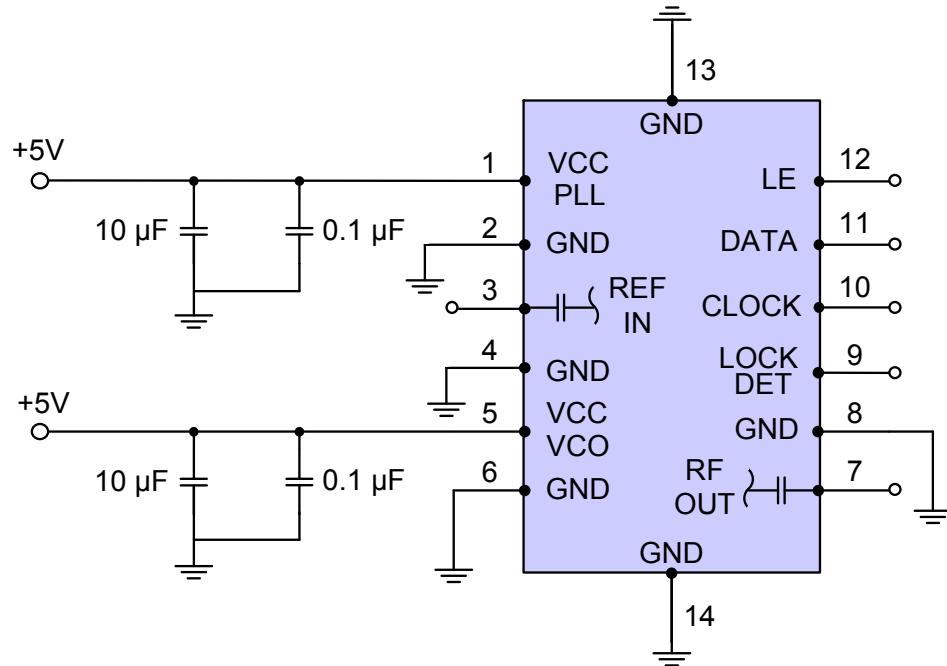

IF/RF MICROWAVE COMPONENTS • ISO 9001 ISO 14001 AS9100 CERTIFIED RoHS compliant  
 P.O. Box 350166, Brooklyn, New York 11235-0003 (718) 934-4500 Fax (718) 332-4661



The Design Engineers Search Engine finds the model you need, Instantly • For detailed performance specs & shopping online see



Notes: 1. Performance and quality attributes and conditions not expressly stated in this specification sheet are intended to be excluded and do not form a part of this specification sheet. 2. Electrical specifications and performance data contained herein are based on Mini-Circuit's applicable established test performance criteria and measurement instructions. 3. The parts covered by this specification sheet are subject to Mini-Circuits standard limited warranty and terms and conditions (collectively, "Standard Terms"); Purchasers of this part are entitled to the rights and benefits contained therein. For a full statement of the Standard Terms and the exclusive rights and remedies thereunder, please visit Mini-Circuits' website at [www.minicircuits.com/MCLStore/terms.jsp](http://www.minicircuits.com/MCLStore/terms.jsp).

## Device Marking

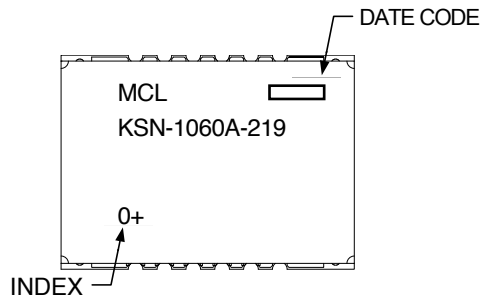

### Additional Detailed Technical Information

Additional information is available on our web site. To access this information enter the model number on our web site home page.

**Case Style:** DK1042

**Tape & Reel:** TR-F28

**Suggested Layout for PCB Design:** PL-249

**Evaluation Board:** TB-567+

**Environment Ratings:** ENV03T2



IF/RF MICROWAVE COMPONENTS • ISO 9001 ISO 14001 AS9100 CERTIFIED RoHS compliant  
P.O. Box 350166, Brooklyn, New York 11235-0003 (718) 934-4500 Fax (718) 332-4661



The Design Engineers Search Engine finds the model you need, Instantly • For detailed performance specs & shopping online see



Notes: 1. Performance and quality attributes and conditions not expressly stated in this specification sheet are intended to be excluded and do not form a part of this specification sheet. 2. Electrical specifications and performance data contained herein are based on Mini-Circuit's applicable established test performance criteria and measurement instructions. 3. The parts covered by this specification sheet are subject to Mini-Circuits standard limited warranty and terms and conditions (collectively, "Standard Terms"); Purchasers of this part are entitled to the rights and benefits contained therein. For a full statement of the Standard Terms and the exclusive rights and remedies thereunder, please visit Mini-Circuits' website at [www.minicircuits.com/MCLStore/terms.jsp](http://www.minicircuits.com/MCLStore/terms.jsp).