

Frequency Synthesizer

KSN-900A-119+

50Ω 840 to 900 MHz

The Big Deal

- Low phase noise and spurious
- Robust design and construction
- Small size 0.800" x 0.584" x 0.154"



CASE STYLE: DK1042

Product Overview

The KSN-900A-119+ is a Frequency Synthesizer, designed to operate from 840 to 900 MHz for WCDMA base station applications. The KSN-900A-119+ is packaged in a metal case (size of 0.800" x 0.584" x 0.154") to shield against unwanted signals and noise.

Key Features

Feature	Advantages
Low phase noise and spurious: <ul style="list-style-type: none">• Phase Noise: -90 dBc/Hz typ. @ 10 kHz offset• Comparison Spurious: -90 dBc typ.• Reference Spurious: -105 dBc typ.	Low phase noise and spurious improve system EVM (Error Vector Magnitude).
Robust design and construction	To enhance the robustness of KSN-900A-119+, each internal component is secured to the substrate with chip bonder, thereby eliminating the risk of tombstoning during subsequent solder reflow operations by the customer.
Small size, 0.800" x 0.584" x 0.154"	The small size enables the KSN-900A-119+ to be used in compact designs.

50Ω 840 to 900 MHz

Features

- Integrated VCO + PLL
- Low phase noise and spurious
- Robust design and construction
- Low operating voltage (VCC VCO=+5V, VCC PLL=+5V)
- Small size 0.800" x 0.584" x 0.154"



CASE STYLE: DK1042
PRICE: \$29.95 ea. QTY (1-9)

+ RoHS compliant in accordance with EU Directive (2002/95/EC)

The +Suffix has been added in order to identify RoHS Compliance. See our web site for RoHS Compliance methodologies and qualifications.

Applications

- WCDMA base station

General Description

The KSN-900A-119+ is a Frequency Synthesizer, designed to operate from 840 to 900 MHz for WCDMA base station application. The KSN-900A-119+ is packaged in a metal case (size of 0.800" x 0.584" x 0.154") to shield against unwanted signals and noise. To enhance the robustness of KSN-900A-119+, each internal component is secured to the substrate with chip bonder, thereby eliminating the risk of tombstoning during subsequent solder reflow operations by the customer.

Simplified Schematic



Electrical Specifications (over operating temperature -40°C to +85°C)

Parameters		Test Conditions	Min.	Typ.	Max.	Units									
Frequency Range		-	840	-	900	MHz									
Step Size		-	-	100	-	kHz									
Settling Time		Within ± 1 kHz	-	1.1	-	mSec									
Output Power		-	-1.0	+2.2	+4.5	dBm									
SSB Phase Noise		@ 100 Hz offset	-	-83	-	dBc/Hz									
		@ 1 kHz offset	-	-84	-77										
		@ 10 kHz offset	-	-90	-85										
		@ 100 kHz offset	-	-124	-117										
		@ 1 MHz offset	-	-148	-142										
Integrated SSB Phase Noise		@ 50Hz - 5MHz	-	-41	-	dBc									
Reference Spurious Suppression		Ref. Freq. 10 MHz	-	-105	-85	dBc									
Comparison Spurious Suppression		Step Size 100 kHz	-	-90	-70										
Non - Harmonic Spurious Suppression		-	-	-90	-										
Harmonic Suppression		-	-	-30	-20										
VCO Supply Voltage		+5.00	+4.85	+5.00	+5.15	V									
PLL Supply Voltage		+5.00	+4.85	+5.00	+5.15										
VCO Supply Current		-	-	16	23	mA									
PLL Supply Current		-	-	8	14										
Reference Input (External)		Frequency	10 (square wave)	-	10	-	MHz								
		Amplitude	1.0	0.8	1.0	1.2	V _{P-P}								
		Input impedance	-	-	100	-	KΩ								
		Phase Noise @ 1 kHz offset	-	-	-145	-	dBc/Hz								
RF Output port Impedance		-	-	50	-	Ω									
Input Logic Level		Input high voltage	-	4.10	-	-	V								
		Input low voltage	-	-	-	0.95	V								
Digital Lock Detect		Locked	-	4.35	-	5.10	V								
		Unlocked	-	-	-	0.40	V								
Frequency Synthesizer PLL		-	ADF4118												
PLL Programming		-	3-wire serial 4.9V CMOS												
Register Map ^{NOTE 1}	F_Register ^{NOTE 2}	<i>Reserved</i>	<i>Power-Down 2</i>	<i>Reserved</i>	<i>Timer Counter Control</i>	<i>Fastlock Mode</i>	<i>Reserved</i>	<i>Fastlock Enable</i>	<i>CP 3-State</i>	<i>PD Polarity</i>	<i>Muxout Control</i>	<i>Power-Down 1</i>	<i>Counter Reset</i>	<i>Control Bits</i>	
		0	0	000	0000	0	0	0	0	1	001	0	0	10	
	N_Register @ 900 MHz	<i>CP Gain</i>	13-Bit B Counter									5-Bit A Counter			<i>Control Bits</i>
		1	0000100011001									01000			01
R_Register	<i>Lock Detect Precision</i>	<i>Test Mode Bits</i>			14-BIT Reference Counter, R									<i>Control Bits</i>	
	1	0000			00000001100100									00	

Note 1: Registers Load Sequence: Initialization Register, F Register, R Register, N Register.

Note 2: For the Initialization Register use Register F with Control Bits 11.

Absolute Maximum Ratings

Parameters	Ratings
VCO Supply Voltage	6V
PLL Supply Voltage	6V
VCO Supply Voltage to PLL Supply Voltage	N.A.
Reference Frequency Voltage	-0.3Vmin, +5.05Vmax
Data, Clock, LE Levels	-0.3Vmin, +5.05Vmax
Operating Temperature	-40°C to +85°C
Storage Temperature	-55°C to +100°C

Permanent damage may occur if any of these limits are exceeded



For detailed performance specs & shopping online see web site

P.O. Box 350166, Brooklyn, New York 11235-0003 (718) 934-4500 Fax (718) 332-4661 The Design Engineers Search Engine Provides ACTUAL Data Instantly at minicircuits.com

Notes: 1. Performance and quality attributes and conditions not expressly stated in this specification sheet are intended to be excluded and do not form a part of this specification sheet. 2. Electrical specifications and performance data contained herein are based on Mini-Circuit's applicable established test performance criteria and measurement instructions. 3. The parts covered by this specification sheet are subject to Mini-Circuits standard limited warranty and terms and conditions (collectively, "Standard Terms"); Purchasers of this part are entitled to the rights and benefits contained therein. For a full statement of the Standard Terms and the exclusive rights and remedies thereunder, please visit Mini-Circuits' website at www.minicircuits.com/MCLStore/terms.jsp.

Typical Performance Data

FREQUENCY (MHz)	POWER OUTPUT (dBm)			VCO CURRENT (mA)			PLL CURRENT (mA)		
	-45°C	+25°C	+85°C	-45°C	+25°C	+85°C	-45°C	+25°C	+85°C
	840	2.36	2.40	2.31	15.28	16.19	16.83	6.71	7.86
846	2.14	2.27	2.24	15.29	16.22	16.87	6.72	7.86	9.04
854	1.94	2.14	2.17	15.33	16.27	16.94	6.75	7.88	9.07
862	1.82	2.08	2.15	15.39	16.34	17.01	6.73	7.87	9.06
870	1.79	2.07	2.18	15.46	16.41	17.09	6.75	7.89	9.08
878	1.83	2.11	2.26	15.53	16.49	17.14	6.75	7.88	9.07
886	1.91	2.19	2.38	15.60	16.55	17.18	6.76	7.90	9.09
894	1.99	2.32	2.49	15.64	16.57	17.18	6.75	7.89	9.08
900	2.06	2.37	2.51	15.65	16.54	17.17	6.75	7.89	9.08

FREQUENCY (MHz)	HARMONICS (dBc)					
	F2			F3		
	-45°C	+25°C	+85°C	-45°C	+25°C	+85°C
840	-26.19	-27.73	-29.60	-35.37	-37.88	-40.97
846	-27.34	-28.67	-30.41	-36.22	-38.94	-42.03
854	-28.23	-29.40	-31.01	-37.31	-39.75	-42.79
862	-29.04	-30.04	-31.51	-38.37	-41.22	-44.34
870	-29.91	-30.80	-32.23	-40.36	-42.37	-45.77
878	-30.51	-31.37	-32.78	-41.12	-43.71	-47.57
886	-31.26	-32.08	-33.32	-42.94	-46.22	-51.20
894	-31.92	-32.52	-33.61	-45.21	-49.38	-52.96
900	-32.18	-32.72	-33.87	-48.73	-52.55	-53.24

FREQUENCY (MHz)	PHASE NOISE (dBc/Hz) @ OFFSETS				
	+25°C				
	100Hz	1kHz	10kHz	100kHz	1MHz
840	-85.10	-82.82	-90.99	-124.63	-149.30
846	-85.08	-83.81	-90.98	-123.74	-150.54
854	-83.76	-83.42	-90.94	-125.28	-149.08
862	-84.30	-82.44	-90.72	-124.14	-150.54
870	-82.86	-83.20	-89.92	-124.46	-149.52
878	-83.39	-82.14	-90.47	-124.40	-150.04
886	-84.42	-83.75	-91.20	-123.54	-147.94
894	-83.18	-82.07	-91.16	-122.54	-146.92
900	-83.44	-83.46	-90.94	-123.51	-147.21

FREQUENCY (MHz)	PHASE NOISE (dBc/Hz) @ OFFSETS				
	-45°C				
	100Hz	1kHz	10kHz	100kHz	1MHz
840	-81.77	-82.79	-90.40	-124.95	-150.35
846	-84.11	-83.34	-90.47	-125.40	-151.33
854	-83.42	-82.16	-90.28	-125.60	-152.10
862	-83.16	-82.11	-90.84	-125.99	-152.95
870	-82.85	-84.28	-89.32	-126.28	-152.96
878	-84.06	-81.60	-90.46	-125.14	-152.74
886	-83.48	-82.80	-91.04	-125.28	-151.96
894	-82.84	-82.76	-90.79	-124.98	-151.17
900	-82.22	-81.69	-91.35	-125.28	-150.42

FREQUENCY (MHz)	PHASE NOISE (dBc/Hz) @ OFFSETS				
	+85°C				
	100Hz	1kHz	10kHz	100kHz	1MHz
840	-81.27	-83.17	-90.63	-123.85	-149.03
846	-83.87	-82.65	-91.32	-123.94	-148.44
854	-86.23	-80.88	-90.42	-123.01	-148.45
862	-82.27	-82.78	-88.91	-122.64	-148.19
870	-85.14	-82.16	-89.41	-123.42	-147.58
878	-83.06	-81.00	-90.37	-123.17	-147.23
886	-82.18	-82.98	-90.72	-120.62	-146.23
894	-82.24	-80.19	-90.72	-122.37	-145.42
900	-81.88	-80.27	-90.24	-122.18	-144.88

COMPARISON SPURIOUS ORDER	COMPARISON SPURIOUS @Fcarrier 840MHz+(n*Fcomparison) (dBc) note 1			COMPARISON SPURIOUS @Fcarrier 870MHz+(n*Fcomparison) (dBc) note 1			COMPARISON SPURIOUS @Fcarrier 900MHz+(n*Fcomparison) (dBc) note 1			
	n	-45°C	+25°C	+85°C	-45°C	+25°C	+85°C	-45°C	+25°C	+85°C
	-5	-102.65	-104.64	-112.57	-108.04	-103.89	-104.36	-111.18	-110.02	-100.99
-4	-102.27	-103.18	-110.00	-106.00	-100.28	-102.01	-108.00	-108.01	-98.51	
-3	-100.18	-102.02	-109.87	-102.25	-95.48	-98.40	-104.11	-106.18	-95.34	
-2	-94.20	-98.54	-110.10	-98.30	-91.10	-95.22	-95.92	-102.35	-91.54	
-1	-86.09	-91.12	-95.65	-83.17	-84.56	-87.12	-79.60	-96.19	-81.84	
0 note 2	-	-	-	-	-	-	-	-	-	
+1	-85.22	-90.71	-96.43	-83.12	-85.46	-87.28	-79.93	-97.65	-81.67	
+2	-93.38	-98.58	-110.02	-98.24	-91.07	-94.52	-95.96	-103.91	-90.85	
+3	-99.63	-103.31	-110.67	-104.23	-95.91	-97.15	-103.07	-106.82	-95.88	
+4	-101.49	-103.08	-114.12	-105.69	-98.93	-100.83	-107.94	-108.10	-99.45	
+5	-101.22	-104.82	-111.93	-111.35	-101.75	-103.55	-109.16	-113.28	-100.63	

Note 1: Comparison frequency 100 kHz

Note 2: All spurs are referenced to carrier signal (n=0).

REFERENCE SPURIOUS ORDER	REFERENCE SPURIOUS @Fcarrier 840MHz+(n*Reference) (dBc) note 3			REFERENCE SPURIOUS @Fcarrier 870MHz+(n*Reference) (dBc) note 3			REFERENCE SPURIOUS @Fcarrier 900MHz+(n*Reference) (dBc) note 3			
	n	-45°C	+25°C	+85°C	-45°C	+25°C	+85°C	-45°C	+25°C	+85°C
	-5	-116.06	-113.65	-112.37	-120.32	-124.84	-122.25	-109.41	-114.24	-117.40
-4	-116.25	-125.85	-119.60	-122.43	-115.81	-120.67	-126.35	-131.05	-122.97	
-3	-109.21	-112.97	-114.76	-110.59	-115.49	-114.17	-108.07	-109.75	-110.58	
-2	-111.62	-125.72	-120.56	-110.87	-113.71	-119.07	-127.77	-129.05	-118.23	
-1	-103.41	-107.04	-113.94	-115.02	-114.78	-113.28	-101.95	-108.49	-110.26	
0 note 4	-	-	-	-	-	-	-	-	-	
+1	-99.95	-102.55	-104.63	-101.45	-104.50	-105.79	-100.01	-101.67	-103.16	
+2	-124.19	-128.32	-122.38	-110.76	-111.70	-110.30	-119.09	-123.02	-121.34	
+3	-106.79	-108.52	-109.92	-116.14	-116.57	-118.16	-117.39	-115.00	-115.71	
+4	-122.71	-128.26	-118.34	-114.14	-115.48	-113.75	-120.77	-123.38	-122.61	
+5	-110.50	-111.94	-111.45	-125.92	-120.91	-120.44	-115.79	-115.04	-115.60	

Note 3: Reference frequency 10 MHz

Note 4: All spurs are referenced to carrier signal (n=0).



For detailed performance specs & shopping online see web site

P.O. Box 350166, Brooklyn, New York 11235-0003 (718) 934-4500 Fax (718) 332-4661 The Design Engineers Search Engine Provides ACTUAL Data Instantly at minicircuits.com

Notes: 1. Performance and quality attributes and conditions not expressly stated in this specification sheet are intended to be excluded and do not form a part of this specification sheet. 2. Electrical specifications and performance data contained herein are based on Mini-Circuit's applicable established test performance criteria and measurement instructions. 3. The parts covered by this specification sheet are subject to Mini-Circuits standard limited warranty and terms and conditions (collectively, "Standard Terms"); Purchasers of this part are entitled to the rights and benefits contained therein. For a full statement of the Standard Terms and the exclusive rights and remedies thereunder, please visit Mini-Circuits' website at www.minicircuits.com/MCLStore/terms.jsp.

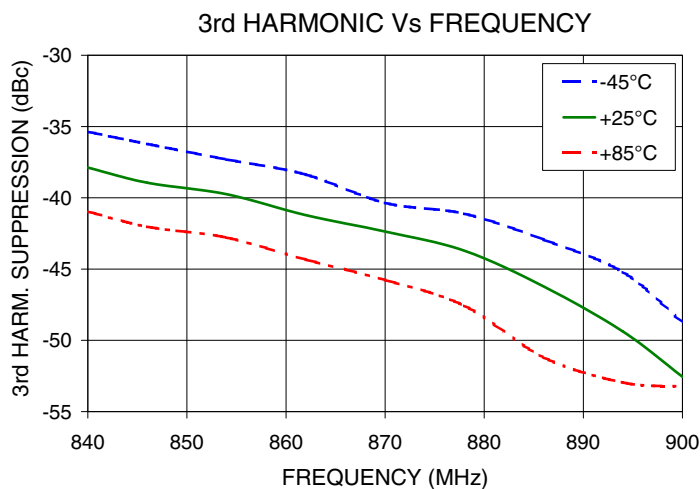
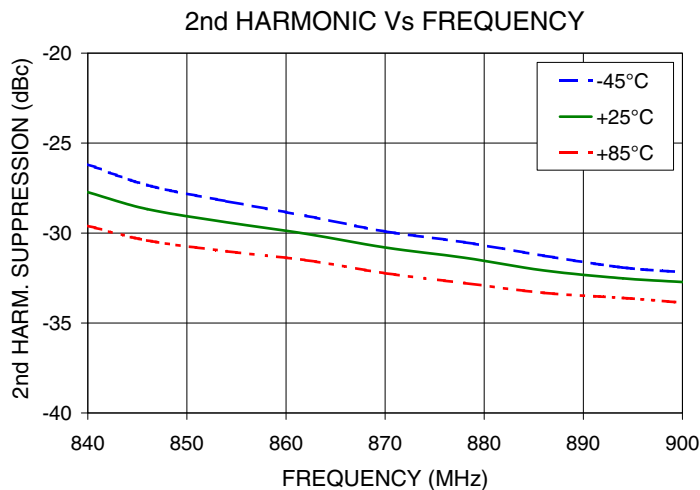
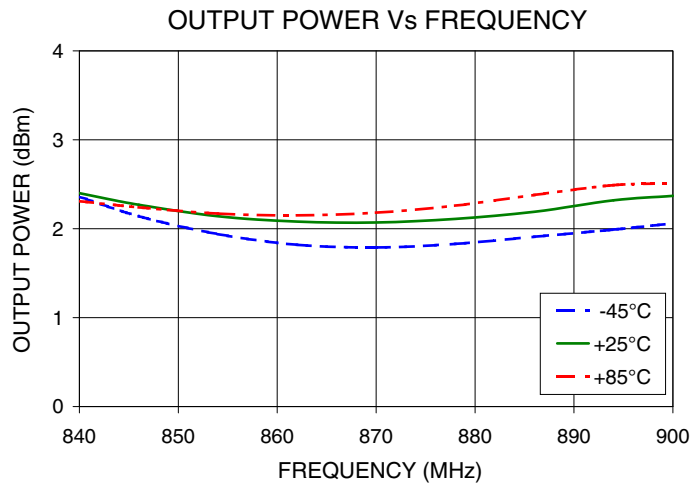

For detailed performance specs & shopping online see web site

P.O. Box 350166, Brooklyn, New York 11235-0003 (718) 934-4500 Fax (718) 332-4661 The Design Engineers Search Engine  Provides ACTUAL Data Instantly at minicircuits.com

Notes: 1. Performance and quality attributes and conditions not expressly stated in this specification sheet are intended to be excluded and do not form a part of this specification sheet. 2. Electrical specifications and performance data contained herein are based on Mini-Circuit's applicable established test performance criteria and measurement instructions. 3. The parts covered by this specification sheet are subject to Mini-Circuits standard limited warranty and terms and conditions (collectively, "Standard Terms"); Purchasers of this part are entitled to the rights and benefits contained therein. For a full statement of the Standard Terms and the exclusive rights and remedies thereunder, please visit Mini-Circuits' website at www.minicircuits.com/MCLStore/terms.jsp.

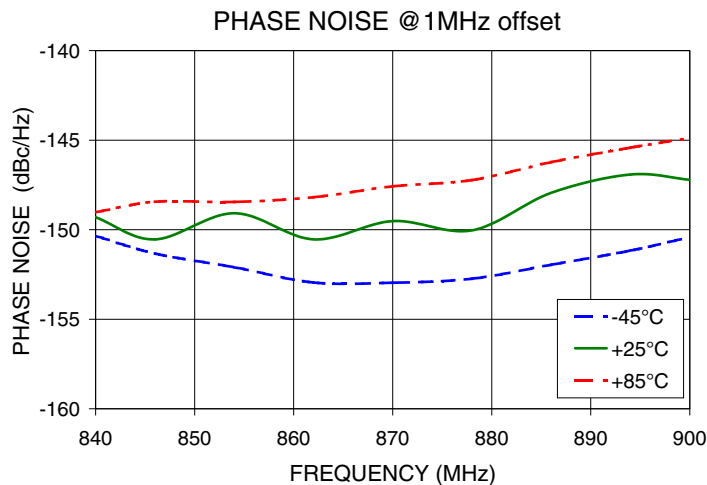
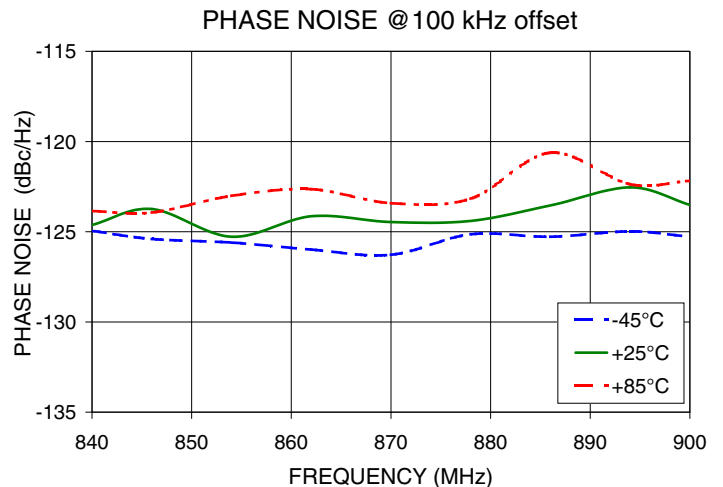
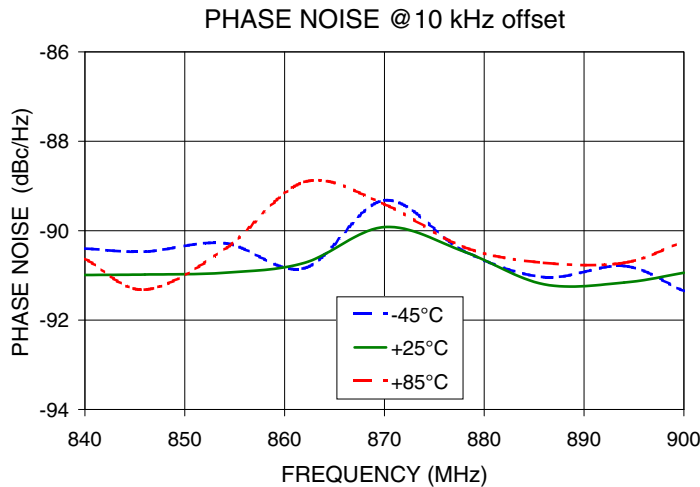
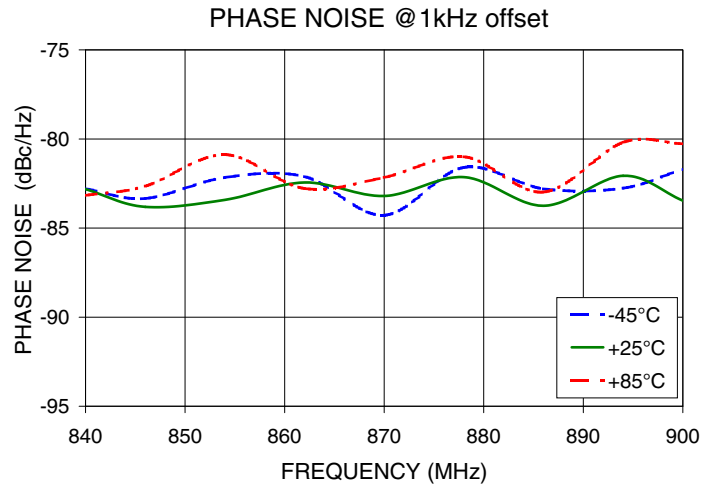
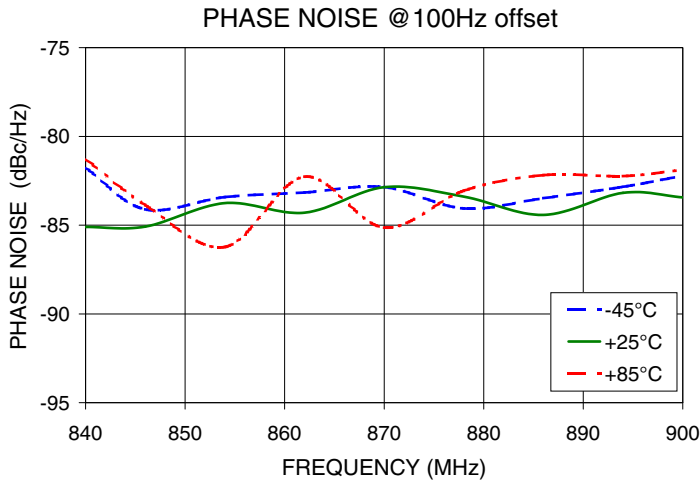

COMPARISON SPURIOUS
Vs FREQ. OFFSET @ Fcar = 840MHz

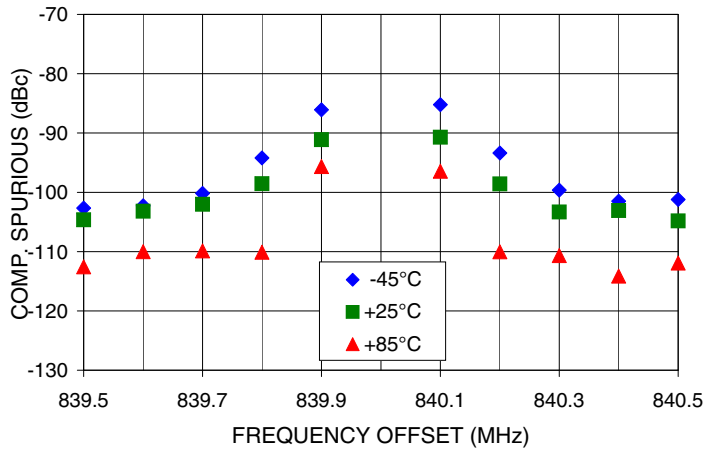

REFERENCE SPURIOUS
Vs FREQ. OFFSET @ Fcar = 840MHz

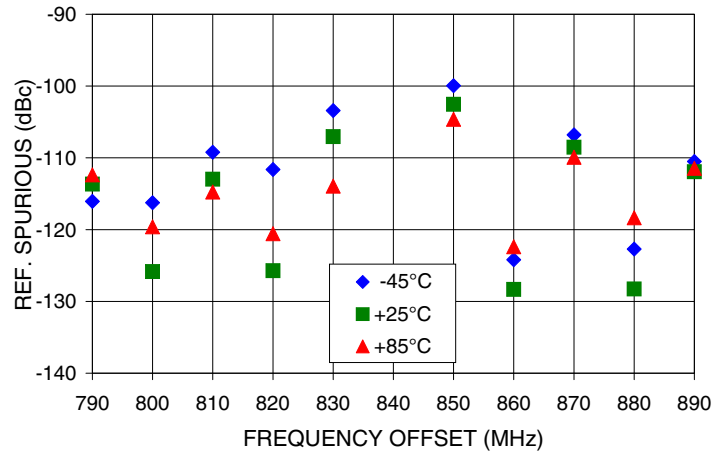

COMPARISON SPURIOUS
Vs FREQ. OFFSET @ Fcar = 870MHz

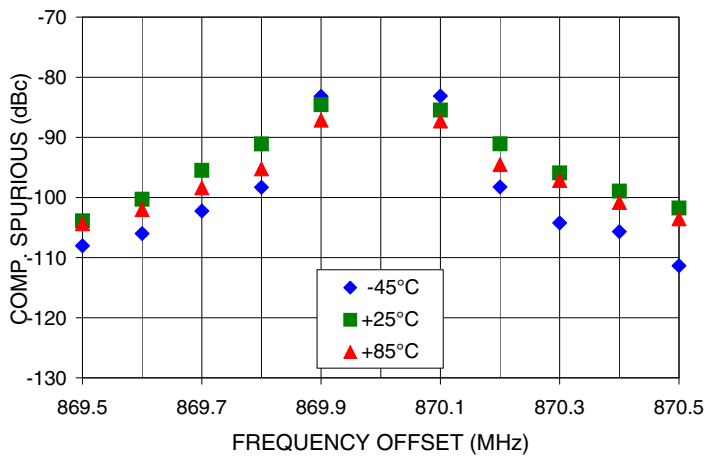

REFERENCE SPURIOUS
Vs FREQ. OFFSET @ Fcar = 870MHz

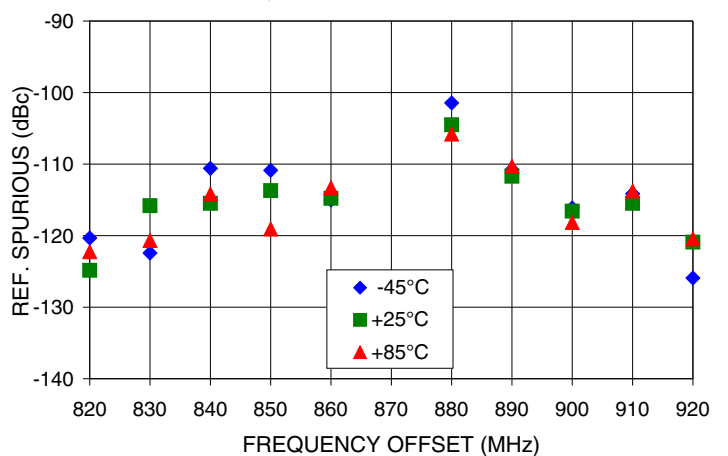

COMPARISON SPURIOUS
Vs FREQ. OFFSET @ Fcar = 900MHz

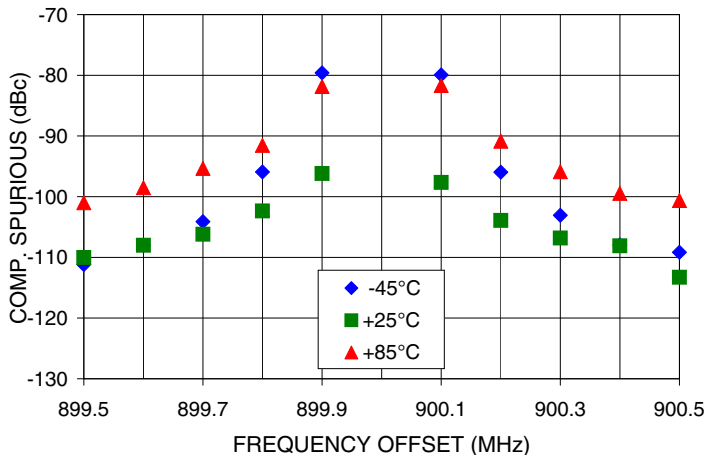

REFERENCE SPURIOUS
Vs FREQ. OFFSET @ Fcar = 900MHz

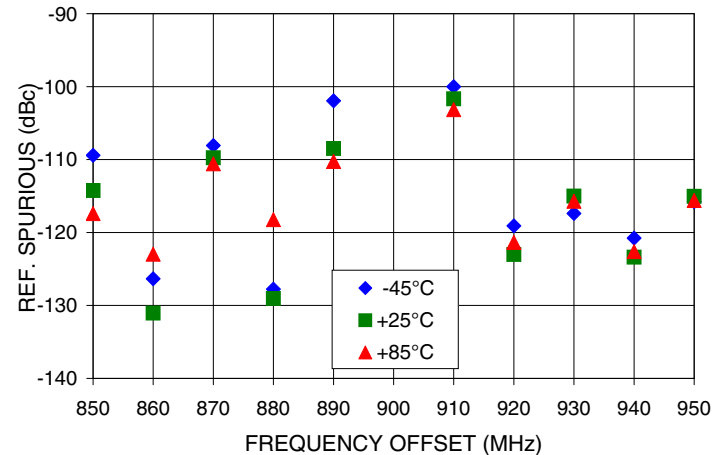

Pin Configuration

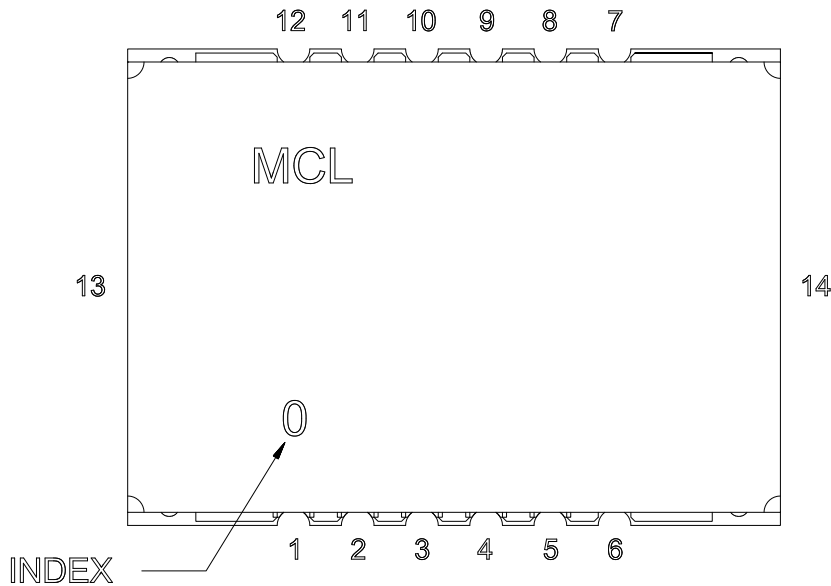

Pin Connection

Pin Number	Function
1	VCC PLL
2	GND
3	REF IN
4	GND
5	VCC VCO
6	GND
7	RF OUT
8	GND
9	LOCK DET
10	CLOCK
11	DATA
12	LE
13	GND
14	GND

Recommended Application Circuit

Note: REF IN and RF OUT ports are internally AC coupled.

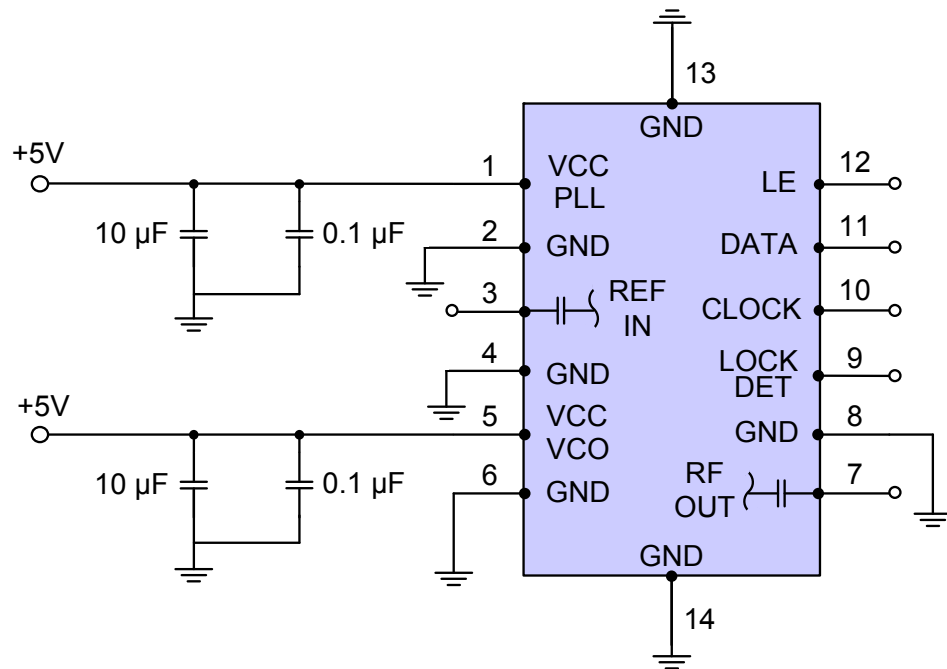

For detailed performance specs & shopping online see web site

P.O. Box 350166, Brooklyn, New York 11235-0003 (718) 934-4500 Fax (718) 332-4661 The Design Engineers Search Engine Provides ACTUAL Data Instantly at minicircuits.com

Notes: 1. Performance and quality attributes and conditions not expressly stated in this specification sheet are intended to be excluded and do not form a part of this specification sheet. 2. Electrical specifications and performance data contained herein are based on Mini-Circuit's applicable established test performance criteria and measurement instructions. 3. The parts covered by this specification sheet are subject to Mini-Circuits standard limited warranty and terms and conditions (collectively, "Standard Terms"); Purchasers of this part are entitled to the rights and benefits contained therein. For a full statement of the Standard Terms and the exclusive rights and remedies thereunder, please visit Mini-Circuits' website at www.minicircuits.com/MCLStore/terms.jsp.

Device Marking

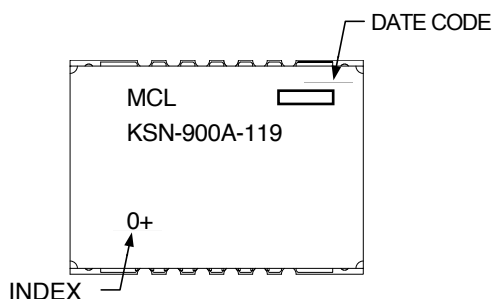

Additional Detailed Technical Information

Additional information is available on our web site. To access this information enter the model number on our web site home page.

Case Style: DK1042

Tape & Reel: TR-F28

Suggested Layout for PCB Design: PL-249

Evaluation Board: TB-567+

Environment Ratings: ENV03T2