

Frequency Synthesizer

KSN-780A-119+

50Ω 729.99 to 780 MHz

The Big Deal

- Low phase noise and spurious
- Robust design and construction
- Small size 0.80" x 0.58" x 0.15"



CASE STYLE: DK801

Product Overview

The KSN-780A-119+ is a Frequency Synthesizer, designed to operate from 729.99 to 780 MHz for CDMA application. The KSN-780A-119+ is packaged in a metal case (size of 0.80" x 0.58" x 0.15") to shield against unwanted signals and noise.

Key Features

Feature	Advantages
Low phase noise and spurious: <ul style="list-style-type: none">• Phase Noise: -110 dBc/Hz typ. @ 10 kHz offset• Comparison Spurious: -88 dBc typ.• Reference Spurious: -95 dBc typ.	Low phase noise and spurious improve system EVM (Error Vector Magnitude).
Robust design and construction	To enhance the robustness of KSN-780A-119+, each internal component is secured to the substrate with chip bonder, thereby eliminating the risk of tombstoning during subsequent solder reflow operations by the customer.
Small size, 0.80" x 0.58" x 0.15"	The small size enables the KSN-780A-119+ to be used in compact designs.



IF/RF MICROWAVE COMPONENTS • ISO 9001 ISO 14001 AS 9100 CERTIFIED RoHS compliant
P.O. Box 350166, Brooklyn, New York 11235-0003 (718) 934-4500 Fax (718) 332-4661



The Design Engineers Search Engine finds the model you need, Instantly • For detailed performance specs & shopping online see



Notes: 1. Performance and quality attributes and conditions not expressly stated in this specification sheet are intended to be excluded and do not form a part of this specification sheet. 2. Electrical specifications and performance data contained herein are based on Mini-Circuit's applicable established test performance criteria and measurement instructions. 3. The parts covered by this specification sheet are subject to Mini-Circuits standard limited warranty and terms and conditions (collectively, "Standard Terms"); Purchasers of this part are entitled to the rights and benefits contained therein. For a full statement of the Standard Terms and the exclusive rights and remedies thereunder, please visit Mini-Circuits' website at www.minicircuits.com/MCLStore/terms.jsp.

Frequency Synthesizer

KSN-780A-119+

50Ω 729.99 to 780 MHz

Features

- Integrated VCO + PLL
- Low phase noise and spurious
- Robust design and construction
- Low operating voltage (VCC VCO=+5V, VCC PLL=+5V)
- Small size 0.80" x 0.58" x 0.15"



CASE STYLE: DK801
PRICE: \$29.95 ea. QTY (1-9)

+ RoHS compliant in accordance with EU Directive (2002/95/EC)

The +Suffix has been added in order to identify RoHS Compliance. See our web site for RoHS Compliance methodologies and qualifications.

Applications

- CDMA

General Description

The KSN-780A-119+ is a Frequency Synthesizer, designed to operate from 729.99 to 780 MHz for CDMA application. The KSN-780A-119+ is packaged in a metal case (size of 0.80" x 0.58" x 0.15") to shield against unwanted signals and noise. To enhance the robustness of KSN-780A-119+, each internal component is secured to the substrate with chip bonder, thereby eliminating the risk of tombstoning during subsequent solder reflow operations by the customer.

Simplified Schematic

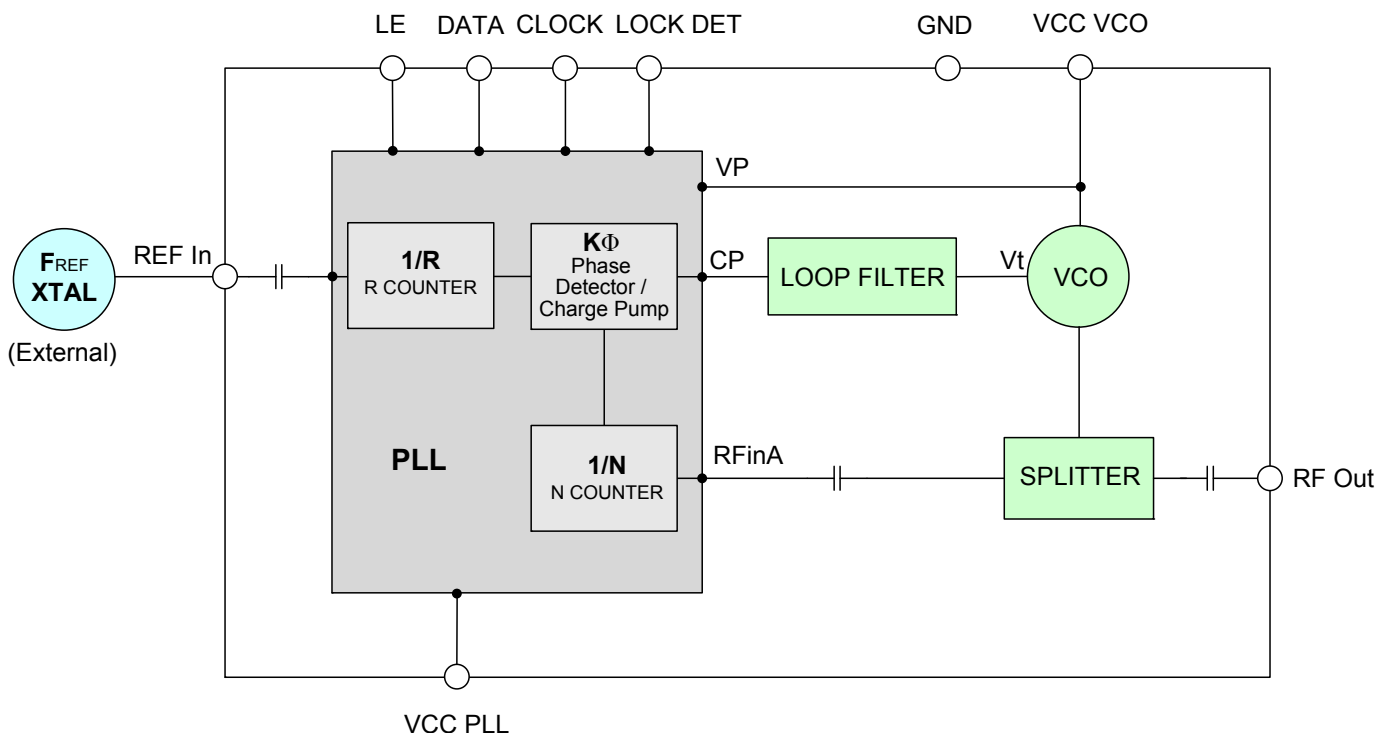

IF/RF MICROWAVE COMPONENTS • ISO 9001 ISO 14001 AS9100 CERTIFIED RoHS compliant
P.O. Box 350166, Brooklyn, New York 11235-0003 (718) 934-4500 Fax (718) 332-4661



The Design Engineers Search Engine finds the model you need, Instantly • For detailed performance specs & shopping online see minicircuits.com

Notes: 1. Performance and quality attributes and conditions not expressly stated in this specification sheet are intended to be excluded and do not form a part of this specification sheet. 2. Electrical specifications and performance data contained herein are based on Mini-Circuit's applicable established test performance criteria and measurement instructions. 3. The parts covered by this specification sheet are subject to Mini-Circuits standard limited warranty and terms and conditions (collectively, "Standard Terms"); Purchasers of this part are entitled to the rights and benefits contained therein. For a full statement of the Standard Terms and the exclusive rights and remedies thereunder, please visit Mini-Circuits' website at www.minicircuits.com/MCLStore/terms.jsp.

REV. OR
M127257
EDR-7425F1
EDR-10429
KSN-780A-119+
Category-A1
RAV
101019
Page 2 of 11

Electrical Specifications (over operating temperature -40°C to +85°C)

Parameters		Test Conditions	Min.	Typ.	Max.	Units	
Frequency Range		-	729.99	-	780	MHz	
Step Size		-	-	30	-	kHz	
Settling Time		Within ± 1 kHz	-	16	-	mSec	
Output Power		-	-3.0	+0.5	+3.0	dBm	
SSB Phase Noise		@ 100 Hz offset	-	-70	-	dBc/Hz	
		@ 1 kHz offset	-	-80	-73		
		@ 10 kHz offset	-	-110	-103		
		@ 100 kHz offset	-	-130	-125		
		@ 1 MHz offset	-	-150	-145		
Reference Spurious Suppression		Ref. Freq. 12 MHz	-	-95	-75	dBc	
Comparison Spurious Suppression		Step Size 30 kHz	-	-88	-70		
Non - Harmonic Spurious Suppression		-	-	-90	-		
Harmonic Suppression		-	-	-25	-20		
VCO Supply Voltage		5.00	+4.75	+5.00	+5.25		V
PLL Supply Voltage		5.00	+4.75	+5.00	+5.25		
VCO Supply Current		-	-	16	22	mA	
PLL Supply Current		-	-	8	14		
Reference Input (External)		Frequency	12 (square wave)	-	12	-	MHz
		Amplitude	1.0	0.8	1.0	1.2	V _{P-P}
		Input impedance	-	-	100	-	KΩ
		Phase Noise @ 1 kHz offset	-	-	-135	-	dBc/Hz
RF Output port Impedance		-	-	50	-	Ω	
Input Logic Level		Input high voltage	-	4.20	-	-	V
		Input low voltage	-	-	-	0.95	V
Digital Lock Detect		Locked	-	4.35	-	5.25	V
		Unlocked	-	-	-	0.40	V
Frequency Synthesizer PLL		-	ADF4118				
PLL Programming		-	3-wire serial 5V CMOS				
Register Map @ 780 MHz		F_Register	-	(MSB) 00000000000010010010 (LSB)			
		N_Register	-	(MSB) 100011001011001000001 (LSB)			
		R_Register	-	(MSB) 10000000011001000000 (LSB)			

Absolute Maximum Ratings

Parameters	Ratings
VCO Supply Voltage	7V
PLL Supply Voltage	7V
VCO Supply Voltage to PLL Supply Voltage	N.A.
Reference Frequency Voltage	-0.3Vmin, VCC PLL +0.3Vmax
Data, Clock, LE Levels	-0.3Vmin, VCC PLL +0.3Vmax
Operating Temperature	-40°C to +85°C
Storage Temperature	-55°C to +100°C

Permanent damage may occur if any of these limits are exceeded



IF/RF MICROWAVE COMPONENTS • ISO 9001 ISO 14001 AS 9100 CERTIFIED RoHS compliant

P.O. Box 350166, Brooklyn, New York 11235-0003 (718) 934-4500 Fax (718) 332-4661



The Design Engineers Search Engine finds the model you need, Instantly • For detailed performance specs & shopping online see



Notes: 1. Performance and quality attributes and conditions not expressly stated in this specification sheet are intended to be excluded and do not form a part of this specification sheet. 2. Electrical specifications and performance data contained herein are based on Mini-Circuit's applicable established test performance criteria and measurement instructions. 3. The parts covered by this specification sheet are subject to Mini-Circuits standard limited warranty and terms and conditions (collectively, "Standard Terms"); Purchasers of this part are entitled to the rights and benefits contained therein. For a full statement of the Standard Terms and the exclusive rights and remedies thereunder, please visit Mini-Circuits' website at www.minicircuits.com/MCLStore/terms.jsp.

Typical Performance Data

FREQUENCY (MHz)	POWER OUTPUT (dBm)			VCO CURRENT (mA)			PLL CURRENT (mA)		
	-45°C	+25°C	+85°C	-45°C	+25°C	+85°C	-45°C	+25°C	+85°C
	729.99	-0.03	0.31	0.49	14.69	16.03	16.77	6.32	7.62
734.97	0.00	0.35	0.53	14.75	16.10	16.85	6.32	7.63	9.03
741.63	0.04	0.38	0.55	14.83	16.20	16.94	6.32	7.63	9.05
748.29	0.06	0.40	0.56	14.89	16.27	17.02	6.33	7.64	9.06
754.95	0.06	0.40	0.56	14.92	16.32	17.07	6.34	7.64	9.07
761.61	0.04	0.38	0.53	14.93	16.34	17.10	6.34	7.64	9.08
768.27	-0.02	0.32	0.45	14.92	16.34	17.11	6.33	7.65	9.09
774.93	-0.13	0.21	0.34	14.89	16.31	17.10	6.34	7.65	9.10
780.00	-0.23	0.11	0.24	14.85	16.28	17.09	6.34	7.65	9.10

FREQUENCY (MHz)	HARMONICS (dBc)					
	F2			F3		
	-45°C	+25°C	+85°C	-45°C	+25°C	+85°C
729.99	-25.89	-26.54	-27.02	-38.13	-39.94	-41.93
734.97	-25.53	-25.96	-26.51	-37.67	-39.49	-41.47
741.63	-26.12	-26.57	-26.84	-37.69	-39.27	-41.16
748.29	-26.25	-26.95	-27.22	-37.67	-39.61	-41.45
754.95	-25.85	-26.28	-26.83	-37.47	-39.07	-41.20
761.61	-25.98	-26.49	-26.89	-37.22	-39.22	-41.06
768.27	-26.20	-27.02	-27.22	-37.18	-38.67	-40.97
774.93	-25.84	-26.36	-26.82	-37.23	-39.26	-41.19
780.00	-25.50	-26.10	-26.49	-37.05	-39.01	-41.16



IF/RF MICROWAVE COMPONENTS • ISO 9001 ISO 14001 AS9100 CERTIFIED RoHS compliant
 P.O. Box 350166, Brooklyn, New York 11235-0003 (718) 934-4500 Fax (718) 332-4661



The Design Engineers Search Engine finds the model you need, Instantly • For detailed performance specs & shopping online see



Notes: 1. Performance and quality attributes and conditions not expressly stated in this specification sheet are intended to be excluded and do not form a part of this specification sheet. 2. Electrical specifications and performance data contained herein are based on Mini-Circuit's applicable established test performance criteria and measurement instructions. 3. The parts covered by this specification sheet are subject to Mini-Circuits standard limited warranty and terms and conditions (collectively, "Standard Terms"); Purchasers of this part are entitled to the rights and benefits contained therein. For a full statement of the Standard Terms and the exclusive rights and remedies thereunder, please visit Mini-Circuits' website at www.minicircuits.com/MCLStore/terms.jsp.

FREQUENCY (MHz)	PHASE NOISE (dBc/Hz) @ OFFSETS				
	+25°C				
	100Hz	1kHz	10kHz	100kHz	1MHz
729.99	-74.71	-79.88	-110.19	-131.76	-151.66
734.97	-71.68	-80.26	-110.08	-131.75	-151.63
741.63	-72.65	-81.34	-110.11	-131.76	-151.52
748.29	-75.53	-79.47	-109.94	-131.66	-151.48
754.95	-75.60	-79.27	-109.94	-131.44	-151.65
761.61	-73.62	-80.36	-109.71	-131.23	-151.49
768.27	-74.32	-80.54	-109.39	-131.01	-150.86
774.93	-72.95	-80.41	-109.20	-130.57	-150.73
780.00	-72.43	-78.79	-109.07	-130.30	-150.26

FREQUENCY (MHz)	PHASE NOISE (dBc/Hz) @ OFFSETS				
	-45°C				
	100Hz	1kHz	10kHz	100kHz	1MHz
729.99	-76.10	-79.24	-111.64	-133.13	-153.27
734.97	-75.05	-79.88	-111.55	-133.18	-153.35
741.63	-75.68	-79.06	-111.64	-133.02	-152.65
748.29	-75.97	-78.72	-111.55	-132.84	-152.71
754.95	-76.18	-78.51	-111.18	-132.60	-152.55
761.61	-75.44	-78.91	-110.99	-132.33	-152.26
768.27	-74.11	-79.58	-110.86	-132.06	-152.09
774.93	-72.89	-79.41	-110.49	-131.76	-151.84
780.00	-75.61	-78.28	-110.28	-131.44	-151.48

FREQUENCY (MHz)	PHASE NOISE (dBc/Hz) @ OFFSETS				
	+85°C				
	100Hz	1kHz	10kHz	100kHz	1MHz
729.99	-72.91	-78.68	-108.70	-130.06	-150.13
734.97	-73.06	-77.73	-109.14	-130.12	-150.16
741.63	-74.17	-77.77	-109.12	-130.13	-150.19
748.29	-75.26	-77.87	-109.15	-130.11	-150.00
754.95	-73.44	-78.49	-108.73	-129.93	-149.84
761.61	-71.84	-77.61	-108.49	-129.66	-149.64
768.27	-71.31	-77.93	-108.25	-129.34	-149.44
774.93	-72.70	-77.71	-107.78	-128.99	-149.11
780.00	-71.93	-77.66	-107.27	-128.74	-148.97



IF/RF MICROWAVE COMPONENTS • ISO 9001 ISO 14001 AS 9100 CERTIFIED RoHS compliant

P.O. Box 350166, Brooklyn, New York 11235-0003 (718) 934-4500 Fax (718) 332-4661



The Design Engineers Search Engine finds the model you need, Instantly • For detailed performance specs & shopping online see



Notes: 1. Performance and quality attributes and conditions not expressly stated in this specification sheet are intended to be excluded and do not form a part of this specification sheet. 2. Electrical specifications and performance data contained herein are based on Mini-Circuit's applicable established test performance criteria and measurement instructions. 3. The parts covered by this specification sheet are subject to Mini-Circuits standard limited warranty and terms and conditions (collectively, "Standard Terms"); Purchasers of this part are entitled to the rights and benefits contained therein. For a full statement of the Standard Terms and the exclusive rights and remedies thereunder, please visit Mini-Circuits' website at www.minicircuits.com/MCLStore/terms.jsp.

COMPARISON SPURIOUS ORDER	COMPARISON SPURIOUS @ Fcarrier 729.99MHz+(n*Fference) (dBc) note 1			COMPARISON SPURIOUS @ Fcarrier 755.01MHz+(n*Fference) (dBc) note 1			COMPARISON SPURIOUS @ Fcarrier 780MHz+(n*Fference) (dBc) note 1			
	n	-45°C	+25°C	+85°C	-45°C	+25°C	+85°C	-45°C	+25°C	+85°C
	-5	-94.04	-94.37	-96.13	-94.41	-97.05	-96.68	-93.55	-96.51	-95.23
-4	-87.91	-91.92	-92.88	-93.24	-93.78	-94.12	-91.44	-90.55	-91.48	
-3	-91.13	-89.75	-90.06	-89.93	-87.70	-86.74	-89.72	-87.38	-88.61	
-2	-90.95	-89.51	-87.89	-90.58	-90.15	-84.49	-88.07	-90.46	-88.90	
-1	-90.85	-91.80	-87.62	-87.45	-89.22	-90.38	-89.57	-90.61	-91.10	
0 note 2	-	-	-	-	-	-	-	-	-	
+1	-91.63	-88.19	-87.54	-85.70	-89.80	-89.70	-87.15	-89.17	-87.72	
+2	-85.20	-91.81	-90.40	-86.98	-83.30	-87.37	-90.20	-87.62	-90.45	
+3	-89.27	-90.78	-87.40	-88.74	-89.99	-91.01	-91.31	-91.36	-90.21	
+4	-87.94	-94.75	-88.18	-89.76	-92.84	-89.30	-87.24	-92.47	-93.42	
+5	-95.01	-92.83	-92.00	-95.21	-97.29	-92.46	-93.06	-95.18	-96.04	

Note 1: Comparison frequency 30 kHz
 Note 2: All spurs are referenced to carrier signal (n=0).

REFERENCE SPURIOUS ORDER	REFERENCE SPURIOUS @ Fcarrier 729.99MHz+(n*Fference) (dBc) note 3			REFERENCE SPURIOUS @ Fcarrier 755.01MHz+(n*Fference) (dBc) note 3			REFERENCE SPURIOUS @ Fcarrier 780MHz+(n*Fference) (dBc) note 3			
	n	-45°C	+25°C	+85°C	-45°C	+25°C	+85°C	-45°C	+25°C	+85°C
	-5	-94.10	-96.78	-98.97	-106.59	-108.65	-108.75	-94.65	-102.55	-111.83
-4	-117.02	-116.74	-119.26	-116.07	-119.79	-119.55	-98.36	-107.17	-110.46	
-3	-108.51	-110.95	-109.55	-108.47	-108.66	-110.65	-93.36	-101.82	-108.99	
-2	-117.61	-118.96	-120.43	-115.88	-118.73	-115.06	-102.48	-108.14	-118.95	
-1	-106.39	-105.91	-106.66	-105.76	-107.76	-106.57	-95.22	-104.68	-103.11	
0 note 4	-	-	-	-	-	-	-	-	-	
+1	-107.53	-110.11	-108.08	-112.83	-108.55	-112.86	-89.96	-118.01	-98.38	
+2	-116.84	-119.81	-121.12	-118.99	-120.32	-117.54	-103.36	-101.56	-99.76	
+3	-112.68	-110.49	-109.79	-113.17	-110.87	-112.39	-97.57	-106.07	-101.21	
+4	-117.67	-117.22	-115.16	-112.33	-115.97	-120.50	-102.22	-102.67	-99.27	
+5	-90.54	-93.69	-96.03	-108.64	-110.46	-109.39	-93.60	-104.06	-102.25	

Note 3: Reference frequency 12 MHz
 Note 4: All spurs are referenced to carrier signal (n=0).



IF/RF MICROWAVE COMPONENTS • ISO 9001 ISO 14001 AS9100 CERTIFIED RoHS compliant
 P.O. Box 350166, Brooklyn, New York 11235-0003 (718) 934-4500 Fax (718) 332-4661



The Design Engineers Search Engine finds the model you need, Instantly • For detailed performance specs & shopping online see



Notes: 1. Performance and quality attributes and conditions not expressly stated in this specification sheet are intended to be excluded and do not form a part of this specification sheet. 2. Electrical specifications and performance data contained herein are based on Mini-Circuit's applicable established test performance criteria and measurement instructions. 3. The parts covered by this specification sheet are subject to Mini-Circuits standard limited warranty and terms and conditions (collectively, "Standard Terms"); Purchasers of this part are entitled to the rights and benefits contained therein. For a full statement of the Standard Terms and the exclusive rights and remedies thereunder, please visit Mini-Circuits' website at www.minicircuits.com/MCLStore/terms.jsp.

Typical Performance Curves

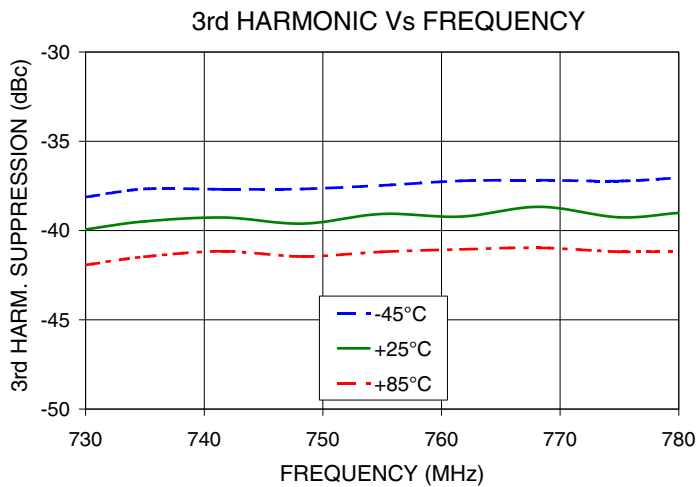
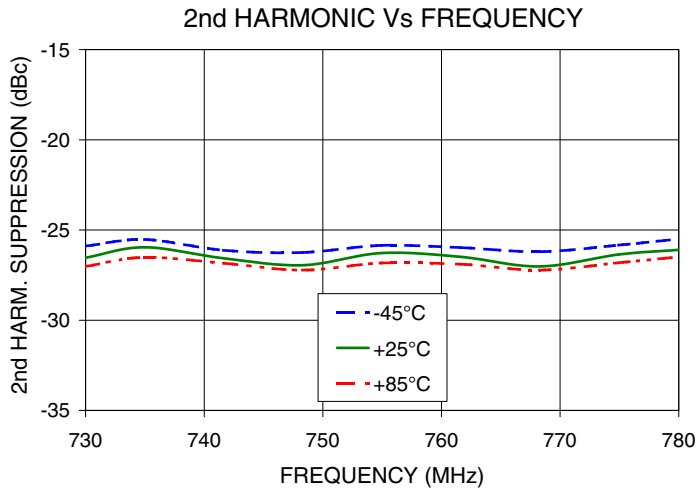
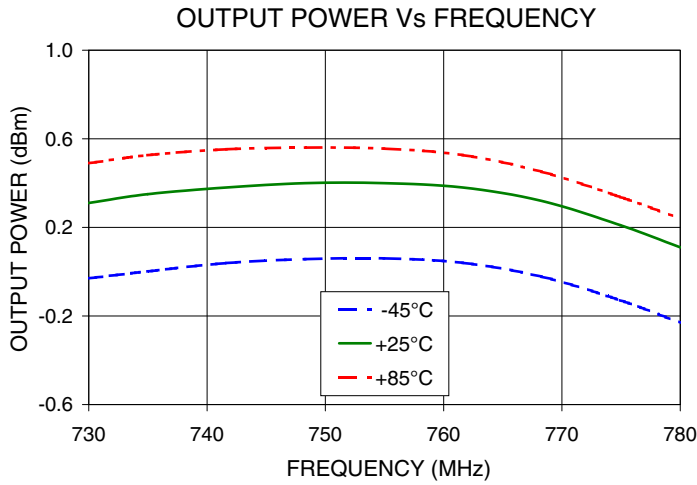

IF/RF MICROWAVE COMPONENTS • ISO 9001 ISO 14001 AS 9100 CERTIFIED RoHS compliant
 P.O. Box 350166, Brooklyn, New York 11235-0003 (718) 934-4500 Fax (718) 332-4661



The Design Engineers Search Engine finds the model you need, Instantly • For detailed performance specs & shopping online see



Notes: 1. Performance and quality attributes and conditions not expressly stated in this specification sheet are intended to be excluded and do not form a part of this specification sheet. 2. Electrical specifications and performance data contained herein are based on Mini-Circuit's applicable established test performance criteria and measurement instructions. 3. The parts covered by this specification sheet are subject to Mini-Circuits standard limited warranty and terms and conditions (collectively, "Standard Terms"); Purchasers of this part are entitled to the rights and benefits contained therein. For a full statement of the Standard Terms and the exclusive rights and remedies thereunder, please visit Mini-Circuits' website at www.minicircuits.com/MCLStore/terms.jsp.

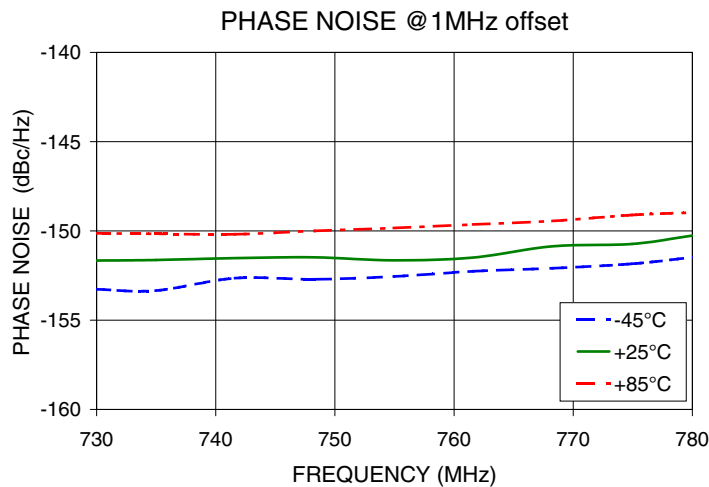
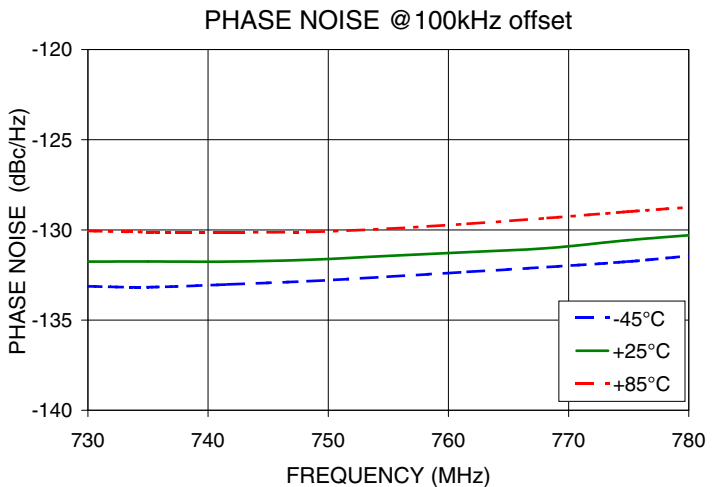
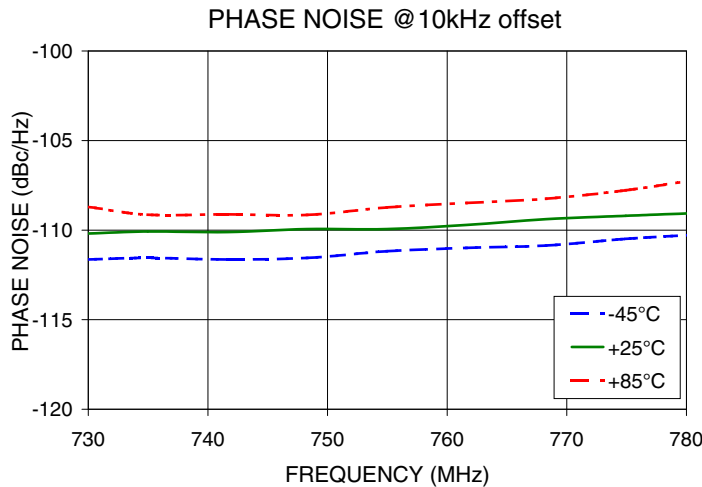
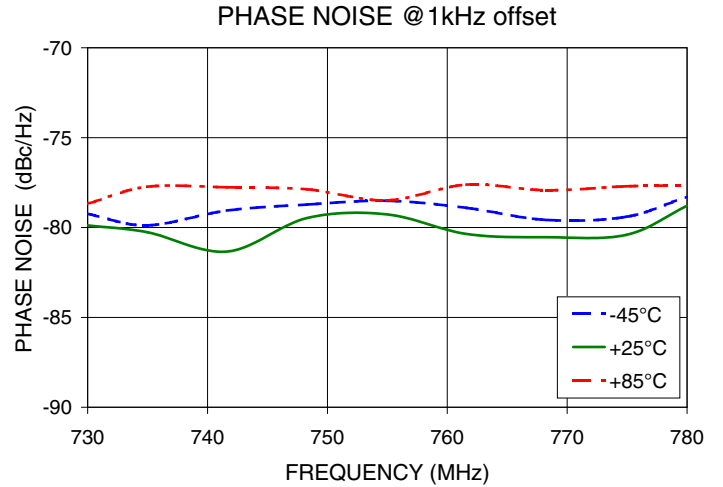
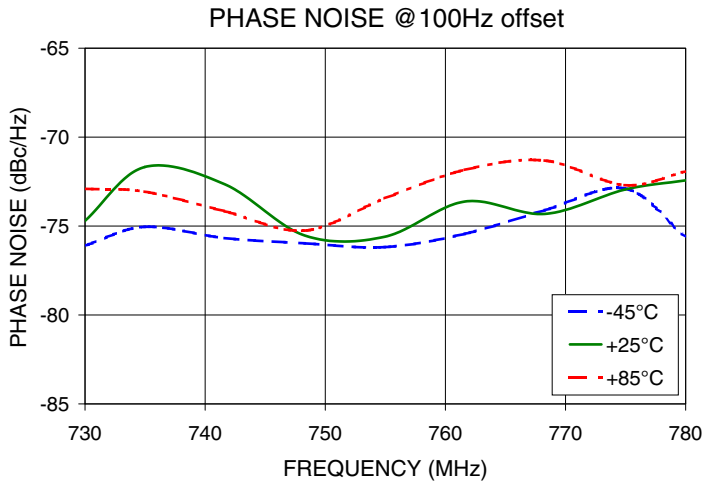

IF/RF MICROWAVE COMPONENTS • ISO 9001 ISO 14001 AS9100 CERTIFIED RoHS compliant
 P.O. Box 350166, Brooklyn, New York 11235-0003 (718) 934-4500 Fax (718) 332-4661



The Design Engineers Search Engine finds the model you need, Instantly • For detailed performance specs & shopping online see



Notes: 1. Performance and quality attributes and conditions not expressly stated in this specification sheet are intended to be excluded and do not form a part of this specification sheet. 2. Electrical specifications and performance data contained herein are based on Mini-Circuit's applicable established test performance criteria and measurement instructions. 3. The parts covered by this specification sheet are subject to Mini-Circuits standard limited warranty and terms and conditions (collectively, "Standard Terms"); Purchasers of this part are entitled to the rights and benefits contained therein. For a full statement of the Standard Terms and the exclusive rights and remedies thereunder, please visit Mini-Circuits' website at www.minicircuits.com/MCLStore/terms.jsp.

COMPARISON SPURIOUS
Vs FREQ. OFFSET @ Fcar = 729.99MHz

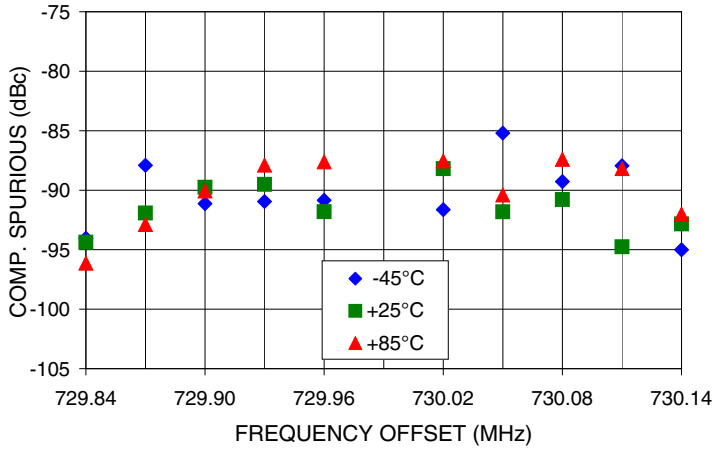

REFERENCE SPURIOUS
Vs FREQ. OFFSET @ Fcar = 729.99MHz

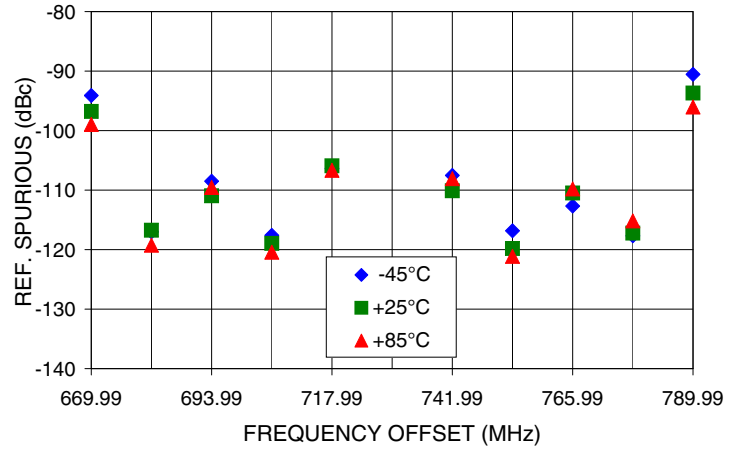

COMPARISON SPURIOUS
Vs FREQ. OFFSET @ Fcar = 755.01MHz

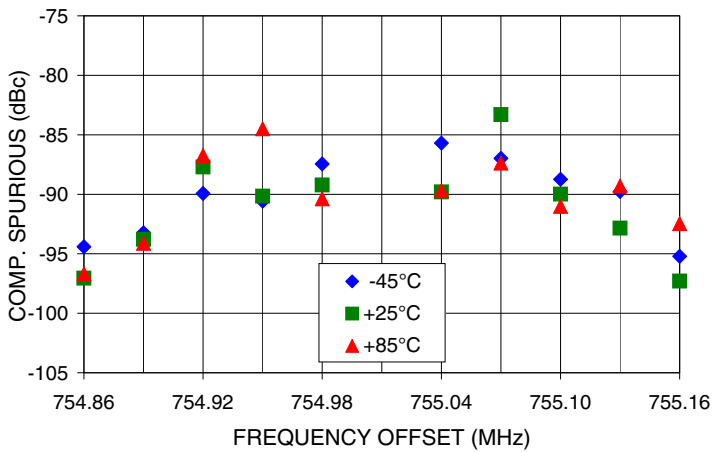

REFERENCE SPURIOUS
Vs FREQ. OFFSET @ Fcar = 755.01MHz

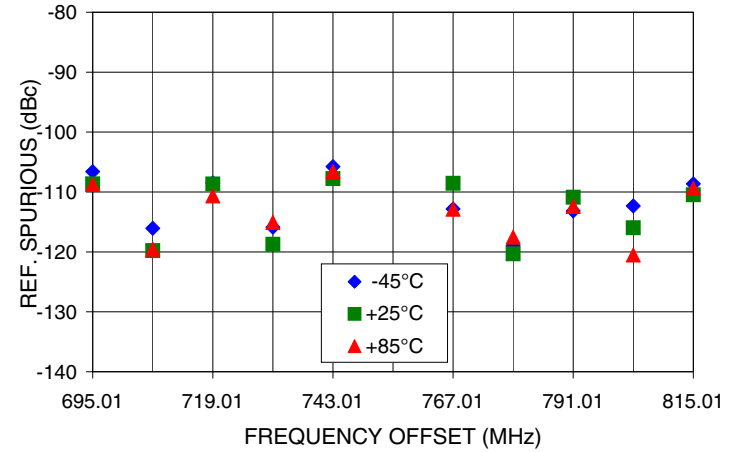

COMPARISON SPURIOUS
Vs FREQ. OFFSET @ Fcar = 780MHz

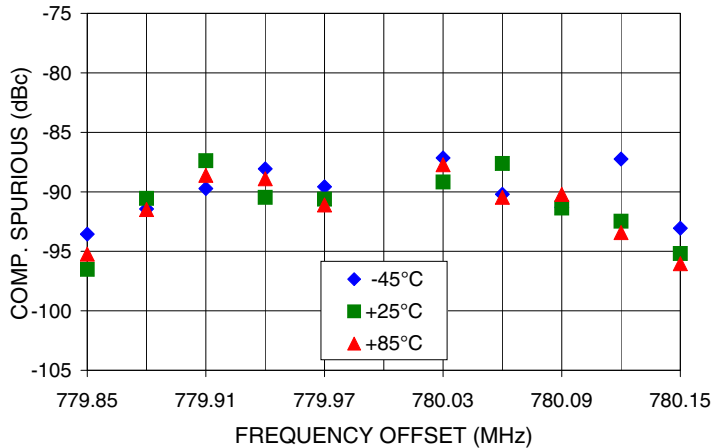

REFERENCE SPURIOUS
Vs FREQ. OFFSET @ Fcar = 780MHz

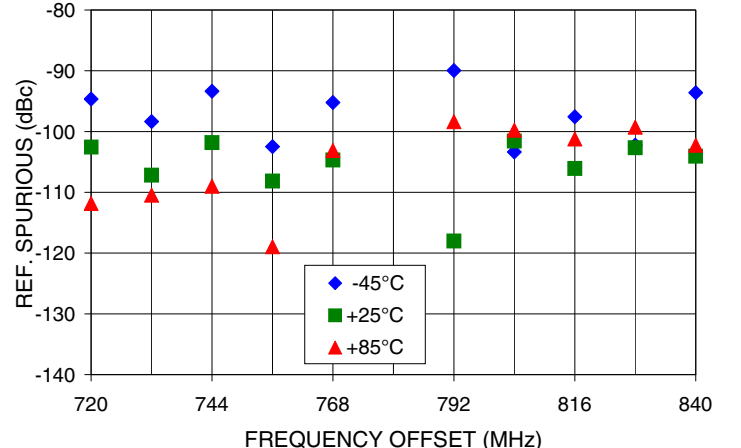

IF/RF MICROWAVE COMPONENTS • ISO 9001 ISO 14001 AS 9100 CERTIFIED RoHS compliant
P.O. Box 350166, Brooklyn, New York 11235-0003 (718) 934-4500 Fax (718) 332-4661



The Design Engineers Search Engine finds the model you need, Instantly • For detailed performance specs & shopping online see



Notes: 1. Performance and quality attributes and conditions not expressly stated in this specification sheet are intended to be excluded and do not form a part of this specification sheet. 2. Electrical specifications and performance data contained herein are based on Mini-Circuit's applicable established test performance criteria and measurement instructions. 3. The parts covered by this specification sheet are subject to Mini-Circuit's standard limited warranty and terms and conditions (collectively, "Standard Terms"); Purchasers of this part are entitled to the rights and benefits contained therein. For a full statement of the Standard Terms and the exclusive rights and remedies thereunder, please visit Mini-Circuits' website at www.minicircuits.com/MCLStore/terms.jsp.

Pin Configuration

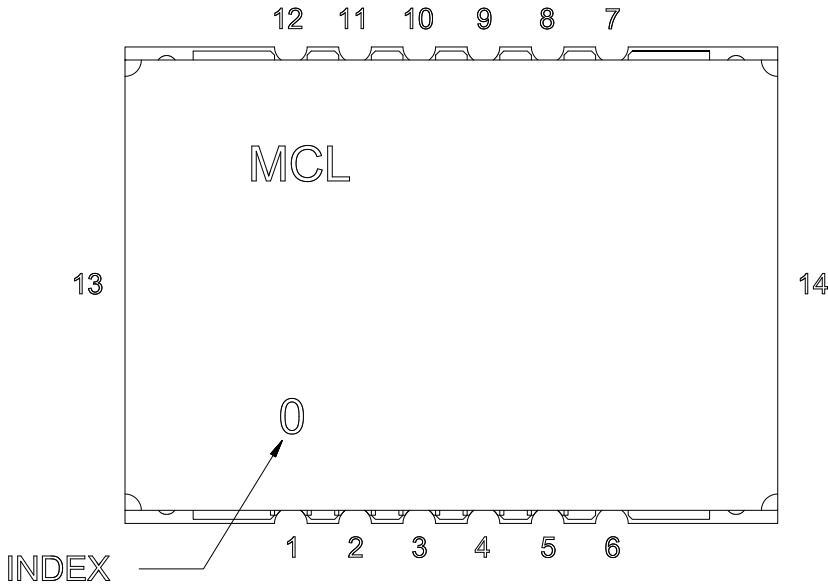

Pin Connection

Pin Number	Function
1	VCC PLL
2	GND
3	REF IN
4	GND
5	VCC VCO
6	GND
7	RF OUT
8	GND
9	LOCK DET
10	CLOCK
11	DATA
12	LE
13	GND
14	GND

Recommended Application Circuit

Note: REF IN and RF OUT ports are internally AC coupled.

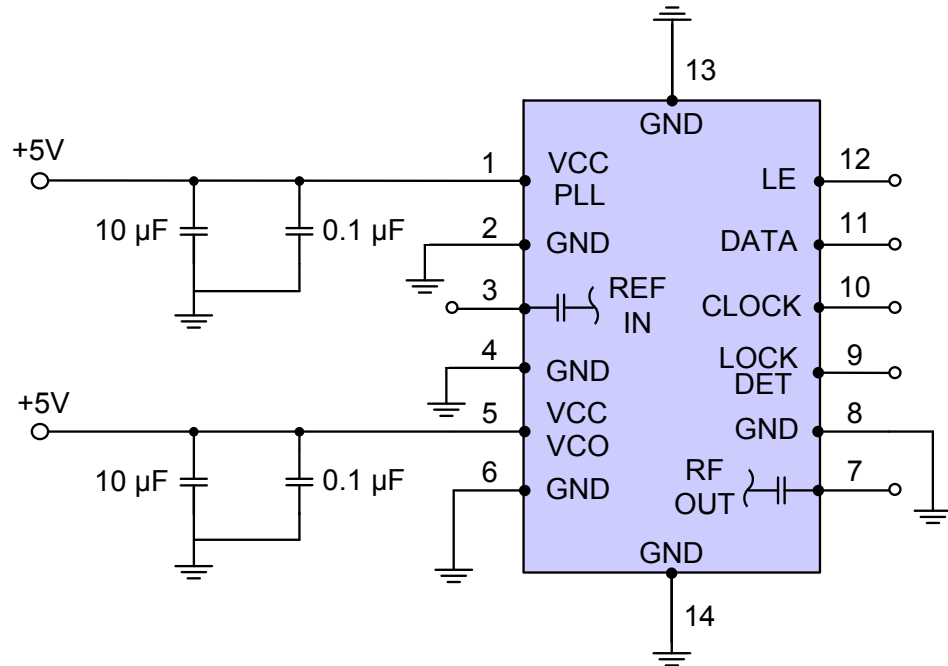

IF/RF MICROWAVE COMPONENTS • ISO 9001 ISO 14001 AS9100 CERTIFIED RoHS compliant
 P.O. Box 350166, Brooklyn, New York 11235-0003 (718) 934-4500 Fax (718) 332-4661



The Design Engineers Search Engine finds the model you need, Instantly • For detailed performance specs & shopping online see



Notes: 1. Performance and quality attributes and conditions not expressly stated in this specification sheet are intended to be excluded and do not form a part of this specification sheet. 2. Electrical specifications and performance data contained herein are based on Mini-Circuit's applicable established test performance criteria and measurement instructions. 3. The parts covered by this specification sheet are subject to Mini-Circuits standard limited warranty and terms and conditions (collectively, "Standard Terms"); Purchasers of this part are entitled to the rights and benefits contained therein. For a full statement of the Standard Terms and the exclusive rights and remedies thereunder, please visit Mini-Circuits' website at www.minicircuits.com/MCLStore/terms.jsp.

Device Marking

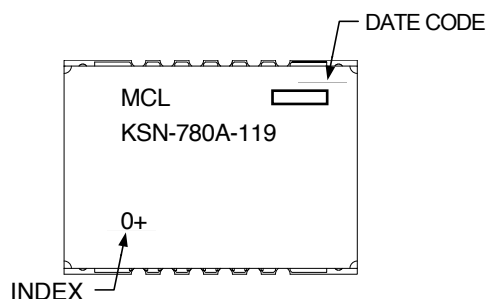

Additional Detailed Technical Information

Additional information is available on our web site. To access this information enter the model number on our web site home page.

Case Style: DK801

Tape & Reel: TR-F28

Suggested Layout for PCB Design: PL-249

Evaluation Board: TB-567+

Environment Ratings: ENV03T2



IF/RF MICROWAVE COMPONENTS • ISO 9001 ISO 14001 AS 9100 CERTIFIED RoHS compliant

P.O. Box 350166, Brooklyn, New York 11235-0003 (718) 934-4500 Fax (718) 332-4661



The Design Engineers Search Engine finds the model you need, Instantly • For detailed performance specs & shopping online see



Notes: 1. Performance and quality attributes and conditions not expressly stated in this specification sheet are intended to be excluded and do not form a part of this specification sheet. 2. Electrical specifications and performance data contained herein are based on Mini-Circuit's applicable established test performance criteria and measurement instructions. 3. The parts covered by this specification sheet are subject to Mini-Circuits standard limited warranty and terms and conditions (collectively, "Standard Terms"); Purchasers of this part are entitled to the rights and benefits contained therein. For a full statement of the Standard Terms and the exclusive rights and remedies thereunder, please visit Mini-Circuits' website at www.minicircuits.com/MCLStore/terms.jsp.