

Frequency Synthesizer

KSN-775A+

50Ω 740 to 775 MHz

The Big Deal

- Low phase noise and spurious
- Robust design and construction
- Small size 0.800" x 0.584" x 0.154"



CASE STYLE: DK1042

Product Overview

The KSN-775A+ is a Frequency Synthesizer, designed to operate from 740 to 775 MHz for W-CDMA applications. The KSN-775A+ is packaged in a metal case (size of 0.800" x 0.584" x 0.154") to shield against unwanted signals and noise.

Key Features

Feature	Advantages
Low phase noise and spurious: <ul style="list-style-type: none">• Phase Noise: -105 dBc/Hz typ. @ 10 kHz offset• Comparison Spurious: -92 dBc typ.• Reference Spurious: -95 dBc typ.	Low phase noise and spurious improve system EVM (Error Vector Magnitude).
Robust design and construction	To enhance the robustness of KSN-775A+, each internal component is secured to the substrate with chip bonder, thereby eliminating the risk of tombstoning during subsequent solder reflow operations by the customer.
Small size, 0.800" x 0.584" x 0.154"	The small size enables the KSN-775A+ to be used in compact designs.



ISO 9001 ISO 14001 AS 9100 CERTIFIED

For detailed performance specs
& shopping online see web site

P.O. Box 350166, Brooklyn, New York 11235-0003 (718) 934-4500 Fax (718) 332-4661 The Design Engineers Search Engine  Provides ACTUAL Data Instantly at minicircuits.com

IFIRF MICROWAVE COMPONENTS

Notes: 1. Performance and quality attributes and conditions not expressly stated in this specification sheet are intended to be excluded and do not form a part of this specification sheet. 2. Electrical specifications and performance data contained herein are based on Mini-Circuit's applicable established test performance criteria and measurement instructions. 3. The parts covered by this specification sheet are subject to Mini-Circuits standard limited warranty and terms and conditions (collectively, "Standard Terms"); Purchasers of this part are entitled to the rights and benefits contained therein. For a full statement of the Standard Terms and the exclusive rights and remedies thereunder, please visit Mini-Circuits' website at www.minicircuits.com/MCLStore/terms.jsp.

50Ω 740 to 775 MHz

Features

- Integrated VCO + PLL
- Low phase noise and spurious
- Robust design and construction
- Low operating voltage (VCC VCO=+5V, VCC PLL=+3.3V)
- Small size 0.800" x 0.584" x 0.154"

Applications

- W-CDMA

General Description

The KSN-775A+ is a Frequency Synthesizer, designed to operate from 740 to 775 MHz for W-CDMA applications. The KSN-775A+ is packaged in a metal case (size of 0.800" x 0.584" x 0.154") to shield against unwanted signals and noise. To enhance the robustness of KSN-775A+, each internal component is secured to the substrate with chip bonder, thereby eliminating the risk of tombstoning during subsequent solder reflow operations by the customer.



CASE STYLE: DK1042
PRICE: \$29.95 ea. QTY (1-9)

+ RoHS compliant in accordance with EU Directive (2002/95/EC)

The +Suffix has been added in order to identify RoHS Compliance. See our web site for RoHS Compliance methodologies and qualifications.

Simplified Schematic

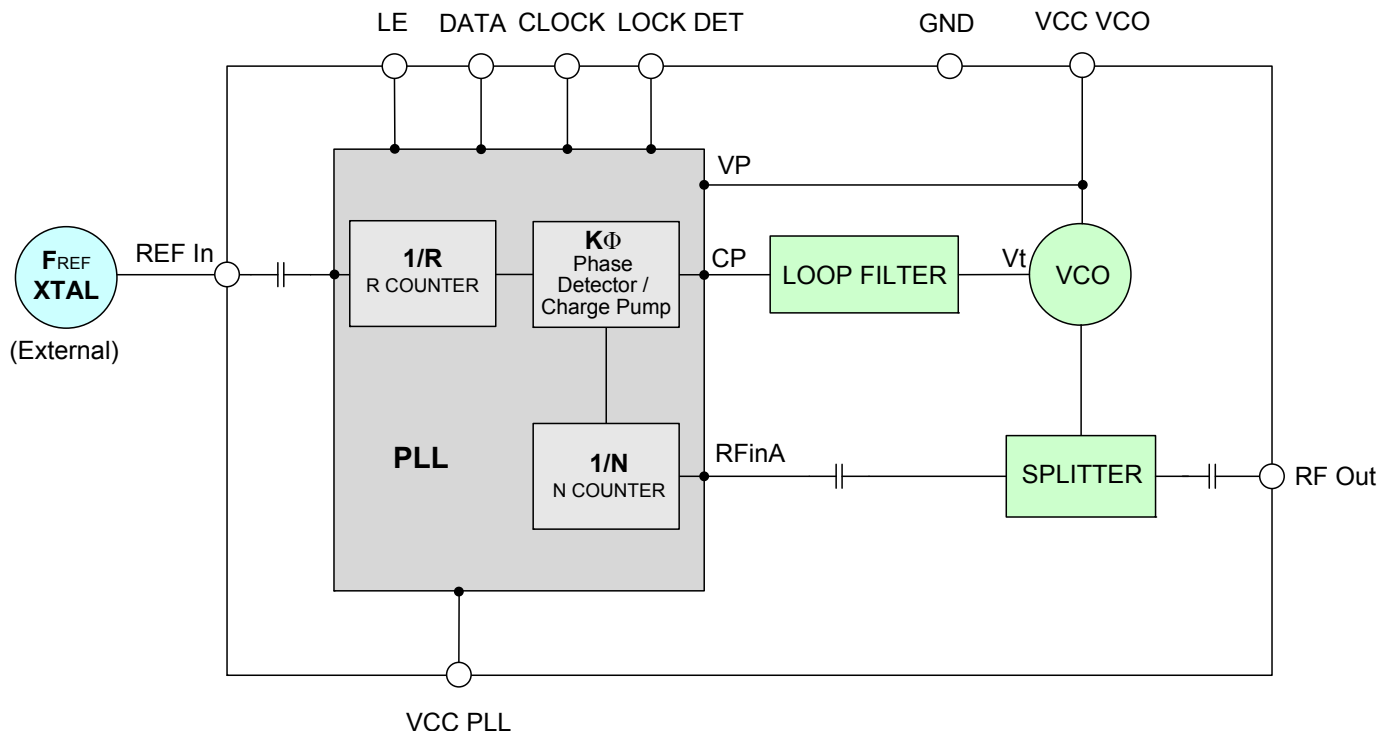

Electrical Specifications (over operating temperature -40°C to +85°C)

Parameters		Test Conditions	Min.	Typ.	Max.	Units								
Frequency Range		-	740	-	775	MHz								
Step Size		-	-	200	-	kHz								
Settling Time		Within ± 500 Hz	-	12	-	mSec								
Output Power		-	0	+3.3	+6	dBm								
SSB Phase Noise		@ 100 Hz offset	-	-84	-	dBc/Hz								
		@ 1 kHz offset	-	-85	-80									
		@ 10 kHz offset	-	-105	-100									
		@ 100 kHz offset	-	-134	-129									
		@ 1 MHz offset	-	-155	-150									
Reference Spurious Suppression		Ref. Freq. 52 MHz	-	-95	-80	dBc								
Comparison Spurious Suppression		Step Size 200 kHz	-	-92	-70									
Non - Harmonic Spurious Suppression		-	-	-90	-									
Harmonic Suppression		-	-	-33	-27									
VCO Supply Voltage		+5.00	+4.75	+5.00	+5.25	V								
PLL Supply Voltage		+3.30	+3.15	+3.30	+3.45									
VCO Supply Current		-	-	30	36	mA								
PLL Supply Current		-	-	7	14									
Reference Input (External)		Frequency	52 (sine wave)		-	52	MHz							
		Amplitude	1		-	1	V _{P-P}							
		Input impedance	-		-	100	KΩ							
		Phase Noise @ 1 kHz offset	-		-	-135	-	dBc/Hz						
RF Output port Impedance		-	-	50	-	Ω								
Input Logic Level		Input high voltage	-	2.75	-	-	V							
		Input low voltage	-	-	-	0.60	V							
Digital Lock Detect		Locked	-	2.60	-	3.45	V							
		Unlocked	-	-	-	0.40	V							
Frequency Synthesizer PLL		-	ADF4118											
PLL Programming		-	3-wire serial 3.3V CMOS											
Register Map ^{NOTE 1}	F_Register ^{NOTE 2}	<i>Reserved</i>	<i>Power-Down 2</i>	<i>Reserved</i>	<i>Timer Counter Control</i>	<i>Fastlock Mode</i>	<i>Reserved</i>	<i>Fastlock Enable</i>	<i>CP 3-State</i>	<i>PD Polarity</i>	<i>Muxout Control</i>	<i>Power-Down 1</i>	<i>Counter Reset</i>	<i>Control Bits</i>
		0	0	000	0000	0	0	0	0	1	001	0	0	10
	N_Register @ 775 MHz	<i>CP Gain</i>	13-Bit B Counter									5-Bit A Counter		<i>Control Bits</i>
		1	0000001111001									00011		01
R_Register	<i>Lock Detect Precision</i>	<i>Test Mode Bits</i>			14-BIT Reference Counter, R								<i>Control Bits</i>	
	1	0000			00000100000100								00	

Note 1: Registers Load Sequence: Initialization Register, F Register, R Register, N Register.

Note 2: For the Initialization Register use Register F with Control Bits 11.

Absolute Maximum Ratings

Parameters	Ratings
VCO Supply Voltage ^{NOTE 3}	5.8V
PLL Supply Voltage ^{NOTE 3}	5.8V
VCO Supply Voltage to PLL Supply Voltage ^{NOTE 3}	-0.3V to +5.5V
Reference Frequency Voltage	-0.3Vmin, +3.3Vmax
Data, Clock, LE Levels	-0.3Vmin, +3.3Vmax
Operating Temperature	-40°C to +85°C
Storage Temperature	-55°C to +100°C

Permanent damage may occur if any of these limits are exceeded

Note 3: Power on/off Sequence: Power on: VCO Supply Voltage, followed by PLL Supply Voltage. Power off: PLL Supply Voltage, followed by VCO Supply Voltage.



For detailed performance specs & shopping online see web site

P.O. Box 350166, Brooklyn, New York 11235-0003 (718) 934-4500 Fax (718) 332-4661 The Design Engineers Search Engine Provides ACTUAL Data Instantly at minicircuits.com

Notes: 1. Performance and quality attributes and conditions not expressly stated in this specification sheet are intended to be excluded and do not form a part of this specification sheet. 2. Electrical specifications and performance data contained herein are based on Mini-Circuit's applicable established test performance criteria and measurement instructions. 3. The parts covered by this specification sheet are subject to Mini-Circuits standard limited warranty and terms and conditions (collectively, "Standard Terms"); Purchasers of this part are entitled to the rights and benefits contained therein. For a full statement of the Standard Terms and the exclusive rights and remedies thereunder, please visit Mini-Circuits' website at www.minicircuits.com/MCLStore/terms.jsp.

Typical Performance Data

FREQUENCY (MHz)	POWER OUTPUT			VCO CURRENT			PLL CURRENT		
	(dBm)			(mA)			(mA)		
	-45°C	+25°C	+85°C	-45°C	+25°C	+85°C	-45°C	+25°C	+85°C
740.0	3.30	3.48	3.39	28.01	29.43	30.24	5.31	6.75	7.88
743.8	3.28	3.46	3.37	28.04	29.45	30.27	5.30	6.75	7.87
750.2	3.25	3.43	3.35	28.06	29.47	30.31	5.30	6.76	7.88
756.6	3.20	3.38	3.31	28.09	29.50	30.33	5.30	6.76	7.89
763.0	3.16	3.34	3.27	28.10	29.51	30.36	5.30	6.76	7.90
769.4	3.13	3.30	3.24	28.09	29.52	30.38	5.31	6.76	7.90
775.0	3.10	3.27	3.21	28.08	29.52	30.37	5.31	6.76	7.90

FREQUENCY (MHz)	HARMONICS (dBc)					
	F2			F3		
	-45°C	+25°C	+85°C	-45°C	+25°C	+85°C
740.0	-30.91	-32.62	-35.16	-51.07	-54.69	-59.17
743.8	-30.93	-32.58	-34.99	-52.21	-56.03	-60.81
750.2	-31.56	-33.24	-35.55	-51.78	-55.48	-61.15
756.6	-31.66	-33.41	-35.75	-52.78	-56.95	-62.07
763.0	-31.30	-33.06	-35.33	-53.12	-57.55	-61.75
769.4	-31.67	-33.36	-35.55	-54.62	-59.28	-64.42
775.0	-31.89	-33.52	-35.63	-54.89	-59.54	-64.15

FREQUENCY (MHz)	PHASE NOISE (dBc/Hz) @ OFFSETS				
	+25°C				
	100Hz	1kHz	10kHz	100kHz	1MHz
740.0	-87.87	-84.44	-105.60	-133.73	-155.65
743.8	-86.05	-85.07	-105.64	-133.90	-154.41
750.2	-85.42	-84.48	-105.43	-134.27	-154.67
756.6	-86.54	-85.09	-104.77	-134.31	-154.82
763.0	-87.06	-87.17	-104.90	-134.58	-156.81
769.4	-86.28	-86.32	-104.95	-134.58	-155.81
775.0	-85.15	-85.62	-105.75	-134.44	-156.31

FREQUENCY (MHz)	PHASE NOISE (dBc/Hz) @ OFFSETS				
	-45°C				
	100Hz	1kHz	10kHz	100kHz	1MHz
740.0	-83.51	-85.76	-104.88	-134.10	-153.55
743.8	-86.04	-86.78	-105.47	-134.29	-155.00
750.2	-85.36	-84.32	-105.12	-134.56	-154.48
756.6	-83.74	-86.00	-105.06	-134.91	-156.98
763.0	-85.00	-84.20	-104.85	-135.32	-157.32
769.4	-86.44	-83.05	-105.66	-135.18	-156.25
775.0	-86.99	-85.39	-105.59	-135.23	-157.51

FREQUENCY (MHz)	PHASE NOISE (dBc/Hz) @ OFFSETS				
	+85°C				
	100Hz	1kHz	10kHz	100kHz	1MHz
740.0	-85.07	-84.41	-104.67	-132.72	-153.67
743.8	-86.08	-85.95	-104.91	-132.76	-154.70
750.2	-86.50	-86.03	-104.58	-132.88	-153.11
756.6	-88.06	-87.51	-103.91	-132.98	-155.29
763.0	-87.75	-84.82	-104.43	-133.01	-155.41
769.4	-85.52	-85.97	-104.59	-133.21	-155.58
775.0	-86.01	-83.61	-104.42	-133.24	-155.54



For detailed performance specs & shopping online see web site

P.O. Box 350166, Brooklyn, New York 11235-0003 (718) 934-4500 Fax (718) 332-4661 The Design Engineers Search Engine Provides ACTUAL Data Instantly at minicircuits.com

IF/RF MICROWAVE COMPONENTS

Notes: 1. Performance and quality attributes and conditions not expressly stated in this specification sheet are intended to be excluded and do not form a part of this specification sheet. 2. Electrical specifications and performance data contained herein are based on Mini-Circuit's applicable established test performance criteria and measurement instructions. 3. The parts covered by this specification sheet are subject to Mini-Circuits standard limited warranty and terms and conditions (collectively, "Standard Terms"); Purchasers of this part are entitled to the rights and benefits contained therein. For a full statement of the Standard Terms and the exclusive rights and remedies thereunder, please visit Mini-Circuits' website at www.minicircuits.com/MCLStore/terms.jsp.

COMPARISON SPURIOUS ORDER	COMPARISON SPURIOUS @Fcarrier 740MHz+(n*Fcomparison) (dBc) note 1			COMPARISON SPURIOUS @Fcarrier 757.6MHz+(n*Fcomparison) (dBc) note 1			COMPARISON SPURIOUS @Fcarrier 775MHz+(n*Fcomparison) (dBc) note 1			
	n	-45°C	+25°C	+85°C	-45°C	+25°C	+85°C	-45°C	+25°C	+85°C
	-5	-111.45	-112.28	-111.31	-110.99	-111.84	-109.18	-117.17	-113.84	-117.16
-4	-113.33	-111.56	-105.43	-109.48	-107.51	-108.99	-117.26	-114.64	-111.92	
-3	-101.10	-101.93	-98.98	-101.15	-99.99	-100.45	-100.86	-101.02	-113.35	
-2	-108.12	-96.49	-93.10	-97.26	-98.58	-96.07	-109.22	-106.47	-106.36	
-1	-95.76	-87.46	-86.82	-94.30	-92.62	-90.30	-96.80	-98.76	-96.67	
0 note 2	-	-	-	-	-	-	-	-	-	
+1	-97.36	-88.21	-86.90	-91.74	-93.26	-90.79	-94.63	-94.50	-93.79	
+2	-109.30	-95.87	-93.95	-97.85	-96.28	-95.55	-108.47	-110.09	-107.19	
+3	-100.48	-102.29	-98.14	-102.00	-102.15	-101.21	-100.91	-101.09	-110.46	
+4	-112.08	-109.05	-105.75	-108.68	-109.61	-108.24	-115.64	-118.66	-114.23	
+5	-110.16	-111.16	-114.21	-111.89	-112.71	-109.18	-115.90	-117.35	-114.78	

Note 1: Comparison frequency 200 kHz

Note 2: All spurs are referenced to carrier signal (n=0).

REFERENCE SPURIOUS ORDER	REFERENCE SPURIOUS @Fcarrier 740MHz+(n*Freference) (dBc) note 3			REFERENCE SPURIOUS @Fcarrier 757.6MHz+(n*Freference) (dBc) note 3			REFERENCE SPURIOUS @Fcarrier 775MHz+(n*Freference) (dBc) note 3			
	n	-45°C	+25°C	+85°C	-45°C	+25°C	+85°C	-45°C	+25°C	+85°C
	-5	-117.30	-125.13	-114.32	-119.54	-117.71	-114.95	-115.35	-115.28	-111.90
-4	-97.06	-97.81	-99.51	-96.92	-97.07	-97.93	-95.21	-95.57	-96.39	
-3	-100.81	-101.45	-102.96	-98.19	-98.65	-100.14	-94.99	-95.48	-96.81	
-2	-91.47	-92.76	-94.04	-104.28	-106.22	-106.37	-107.39	-109.95	-111.51	
-1	-107.10	-108.28	-109.93	-107.19	-108.49	-110.29	-106.95	-108.52	-109.32	
0 note 4	-	-	-	-	-	-	-	-	-	
+1	-106.78	-106.32	-107.18	-106.21	-106.07	-106.53	-106.71	-106.08	-106.02	
+2	-108.49	-108.33	-108.34	-104.62	-106.36	-107.89	-102.96	-104.81	-105.80	
+3	-106.05	-107.18	-106.95	-105.48	-106.67	-106.69	-103.79	-104.13	-104.25	
+4	-103.66	-103.81	-105.59	-103.76	-104.50	-105.68	-103.96	-103.75	-105.33	
+5	-119.45	-120.56	-119.04	-118.41	-128.90	-123.50	-128.17	-128.96	-124.91	

Note 3: Reference frequency 52 MHz

Note 4: All spurs are referenced to carrier signal (n=0).

Typical Performance Curves

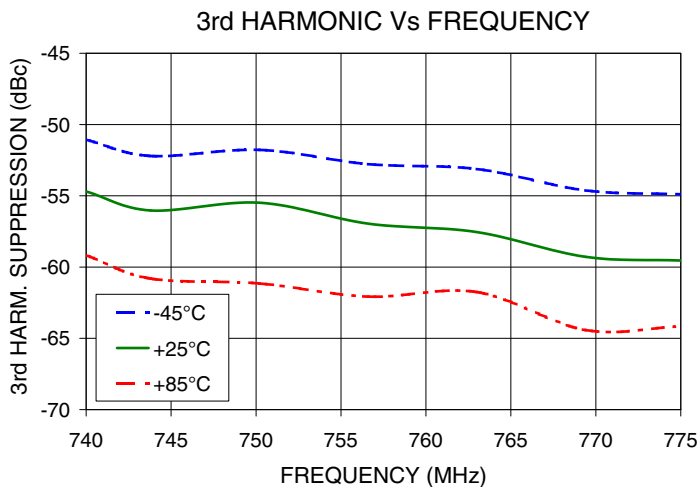
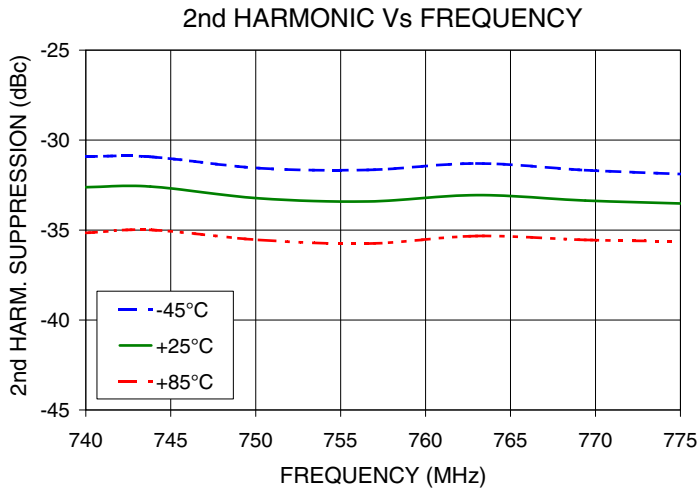
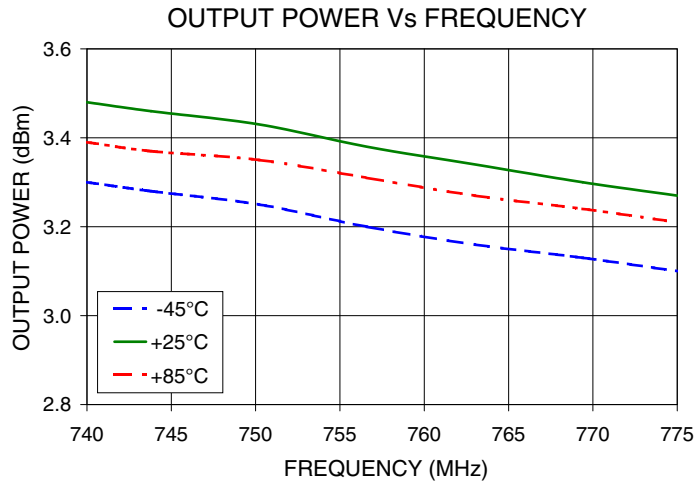

For detailed performance specs & shopping online see web site

P.O. Box 350166, Brooklyn, New York 11235-0003 (718) 934-4500 Fax (718) 332-4661 The Design Engineers Search Engine Provides ACTUAL Data Instantly at minicircuits.com

Notes: 1. Performance and quality attributes and conditions not expressly stated in this specification sheet are intended to be excluded and do not form a part of this specification sheet. 2. Electrical specifications and performance data contained herein are based on Mini-Circuit's applicable established test performance criteria and measurement instructions. 3. The parts covered by this specification sheet are subject to Mini-Circuits standard limited warranty and terms and conditions (collectively, "Standard Terms"); Purchasers of this part are entitled to the rights and benefits contained therein. For a full statement of the Standard Terms and the exclusive rights and remedies thereunder, please visit Mini-Circuits' website at www.minicircuits.com/MCLStore/terms.jsp.

PHASE NOISE @ 100Hz offset

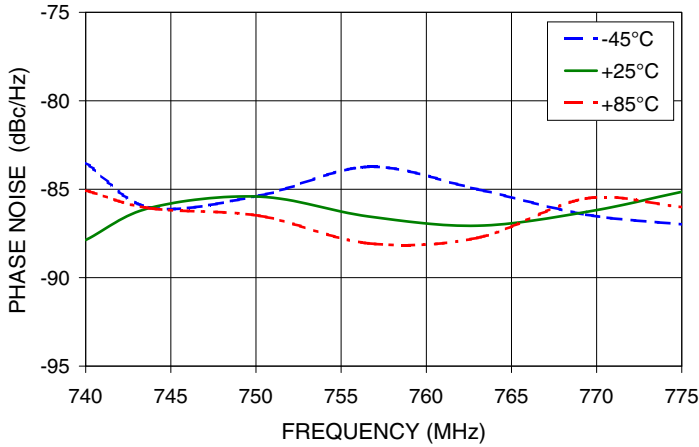

PHASE NOISE @ 1kHz offset

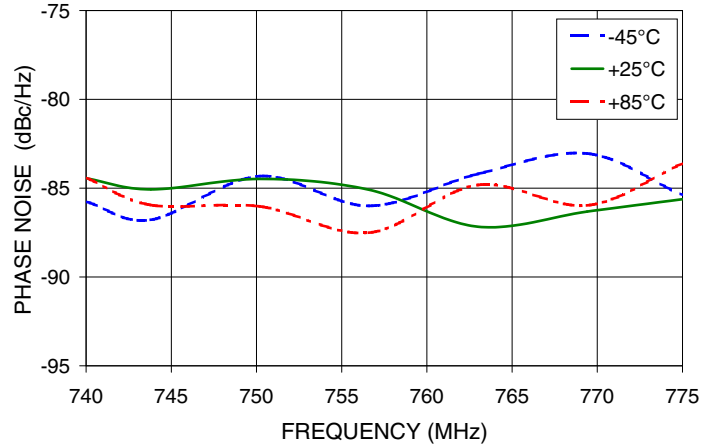

PHASE NOISE @ 10kHz offset

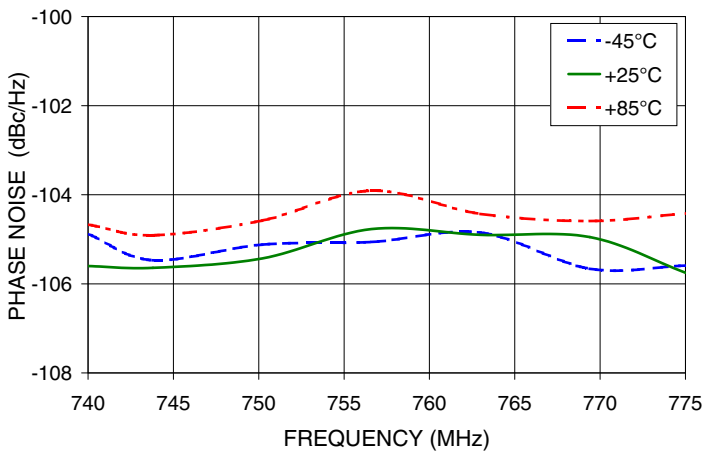

PHASE NOISE @ 100kHz offset

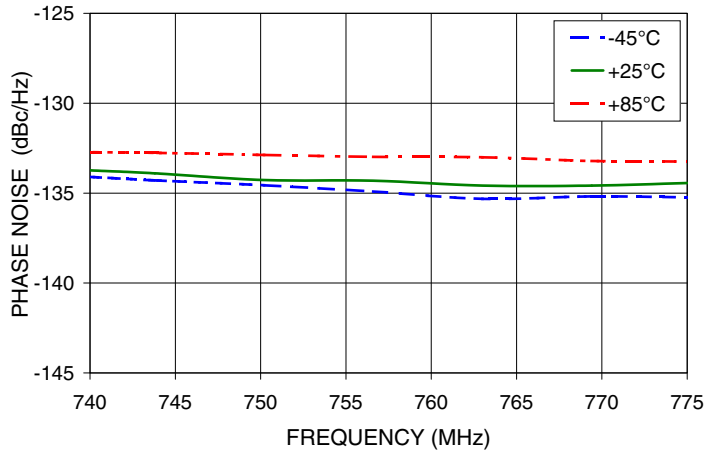

PHASE NOISE @ 1MHz offset

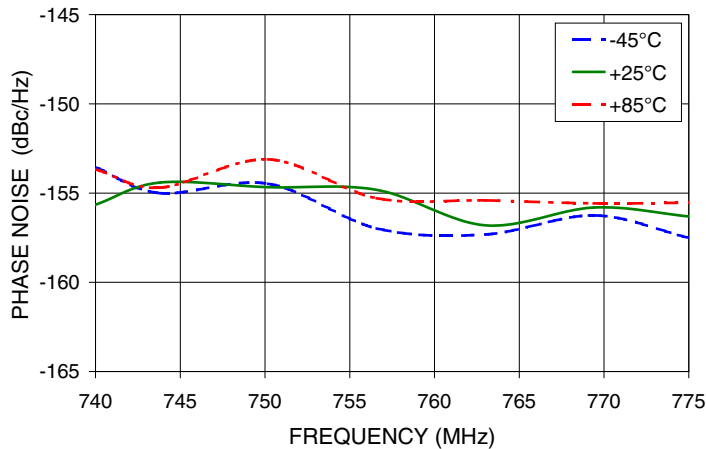

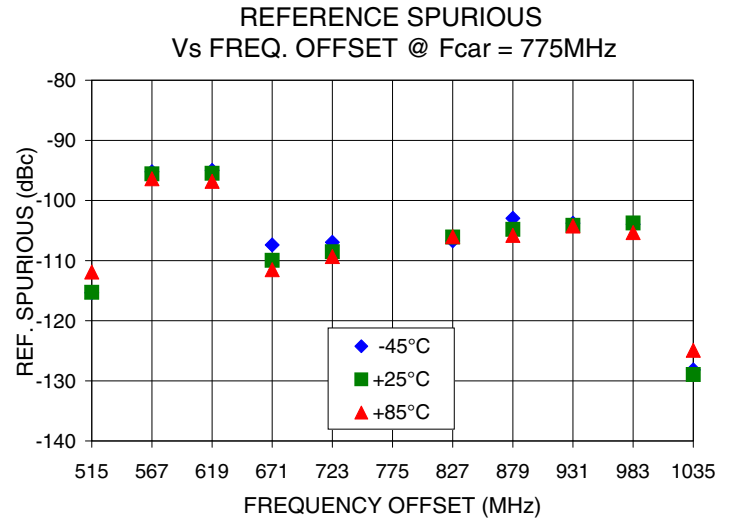
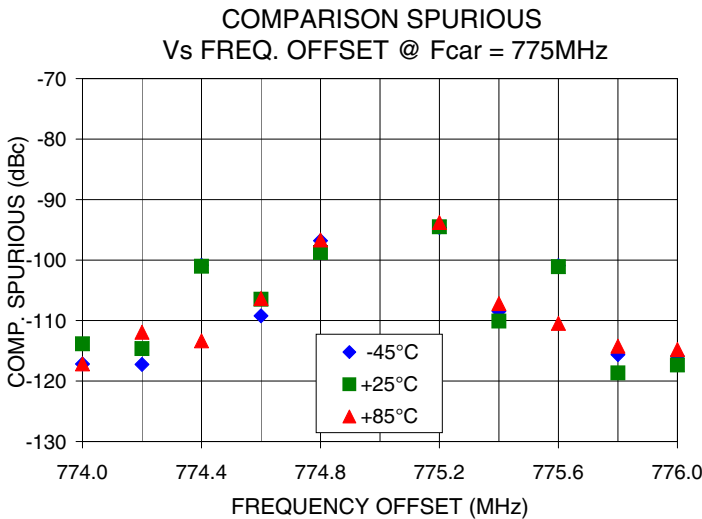
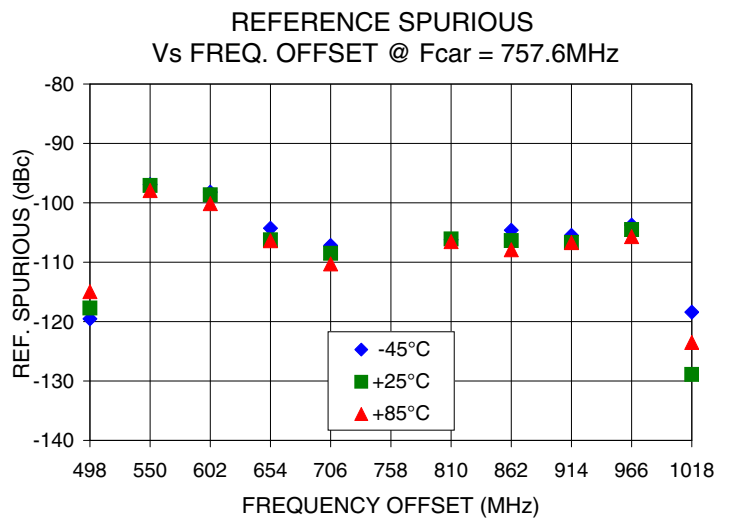
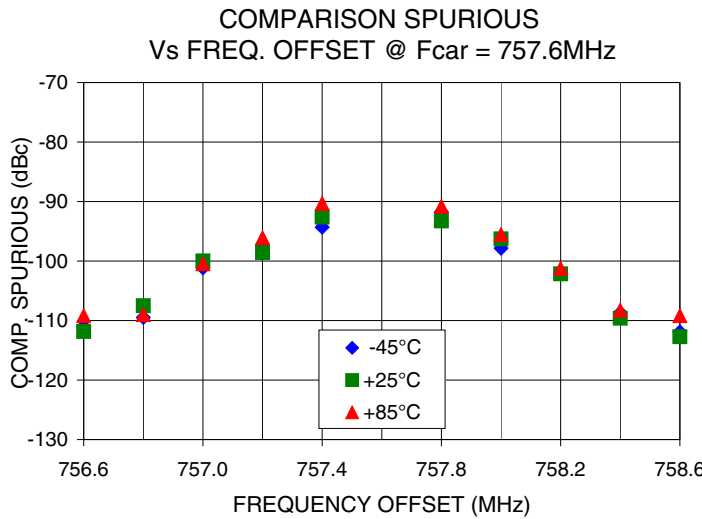
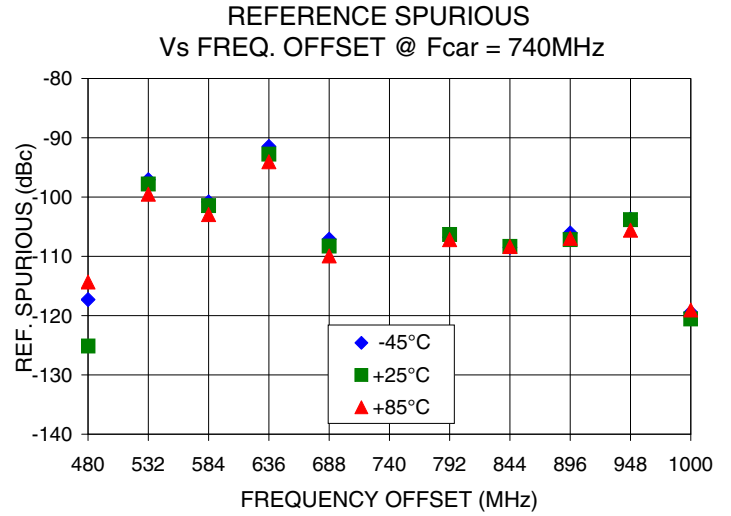
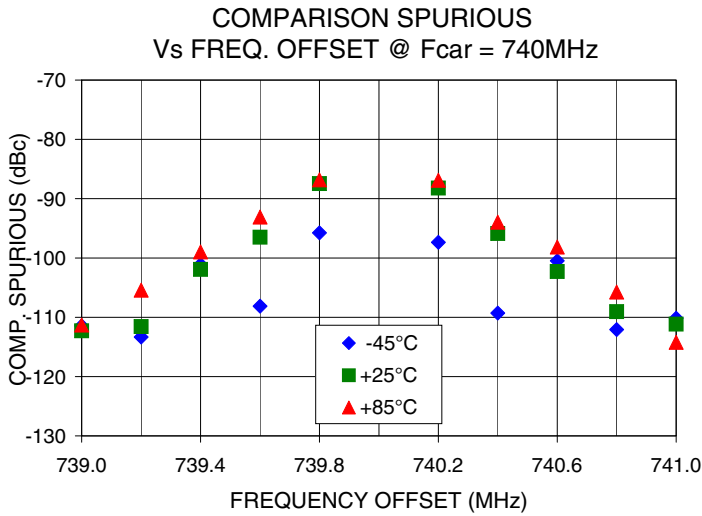

Pin Configuration

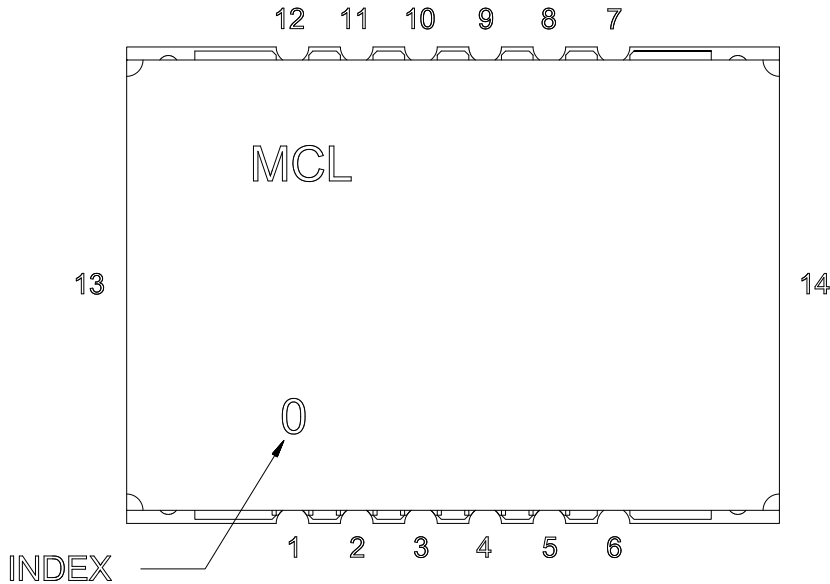

Pin Connection

Pin Number	Function
1	VCC PLL
2	GND
3	REF IN
4	GND
5	VCC VCO
6	GND
7	RF OUT
8	GND
9	LOCK DET
10	CLOCK
11	DATA
12	LE
13	GND
14	GND

Recommended Application Circuit

Note: REF IN and RF OUT ports are internally AC coupled.

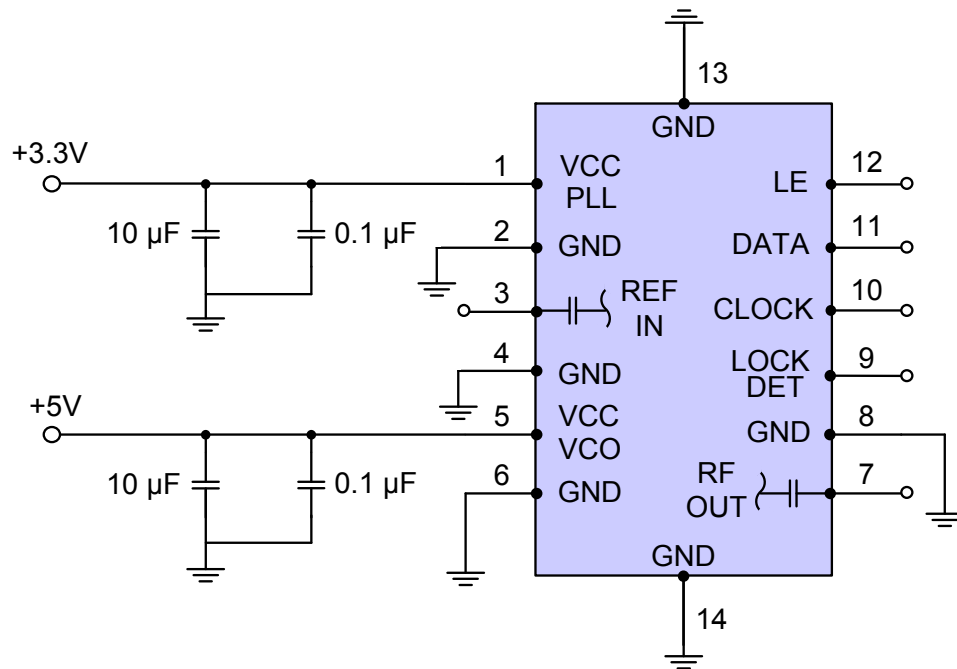

Device Marking

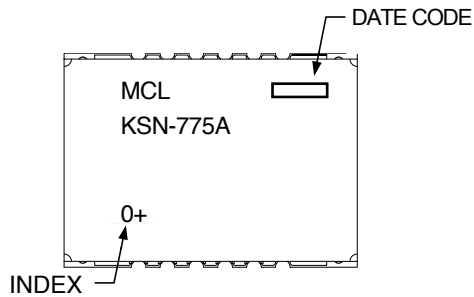

Additional Detailed Technical Information

Additional information is available on our web site. To access this information enter the model number on our web site home page.

Case Style: DK1042

Tape & Reel: TR-F28

Suggested Layout for PCB Design: PL-249

Evaluation Board: TB-567-1+

Environment Ratings: ENV03T2