

# Surface Mount Phase Shifter

50Ω 180° Voltage Variable 1700 to 2000 MHz

## JSPHS-23+

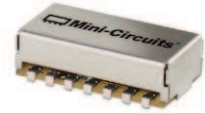

CASE STYLE: BK276  
PRICE: \$32.95 ea. QTY (1-9)

**+RoHS Compliant**  
The +Suffix identifies RoHS Compliance. See our web site for RoHS Compliance methodologies and qualifications

### Maximum Ratings

Operating Temperature	-40°C to 85°C
Storage Temperature	-55°C to 100°C
RF Input Power	20 dBm max.
Control Voltage	28V

Permanent damage may occur if any of these limits are exceeded.

### Pin Connections

IN	1
OUT	7
BIAS	4,6^
GROUND	2,3,5,8,9,10,11,12,13,14

^ proper operation is achieved with pins 4 or 6 or both connected to BIAS.

### Outline Drawing

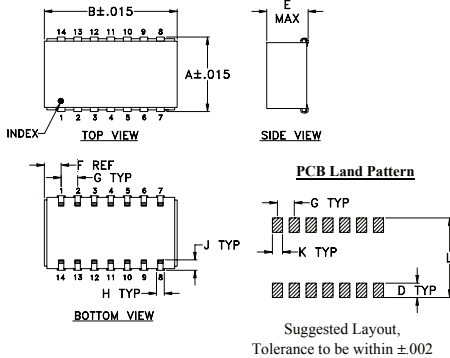

### Outline Dimensions (inch mm)

A	B	C	D	E	F	G
.450	.803	--	.100	.250	.102	.100
11.43	20.40	--	2.54	6.35	2.59	2.54
H	J	K	L	wt		
.047	.065	.065	.470	grams		
1.19	1.65	1.65	11.94	3.0		

### Demo Board MCL P/N: TB-122 Suggested PCB Layout (PL-030)

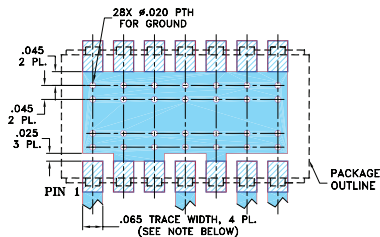

### Features

- low insertion loss, 2.0 dB typ.
- good VSWR, 1.5:1 typ.
- J-leads for excellent solderability and strain relief
- aqueous washable

### Applications

- cellular
- PCS
- DCS

### Phase Shifter Electrical Specifications

FREQUENCY (MHz)	PHASE RANGE (Degrees)	INSERTION LOSS (dB)		CONTROL VOLTAGE (V)	CONTROL BANDWIDTH (kHz)	VSWR (:1)
	Min.	Typ.	Max.			
1700-2000	180	2.0	3.5	0-15	DC-50	1.5 2.9

Maximum operating power, 0 dBm

DC input resistance at Control port: 2000 ohms typ.

### Typical Performance Data

Control Voltage (V)	Phase Shift* (Degrees)			VSWR (:1)			Insertion Loss (dB)		
	1700 MHz	1850 MHz	2000 MHz	1700 MHz	1850 MHz	2000 MHz	1700 MHz	1850 MHz	2000 MHz
0.0	0.02	0.01	0.02	1.25	1.06	1.43	1.64	1.60	1.74
1.0	7.14	6.46	5.81	1.32	1.12	1.33	1.73	1.66	1.73
3.0	24.81	22.12	19.98	1.47	1.31	1.12	1.98	1.85	1.76
5.0	65.00	55.13	49.59	1.56	1.62	1.27	2.41	2.31	2.03
7.0	150.40	119.13	101.78	1.34	1.45	1.80	2.86	2.56	2.60
9.0	211.72	175.86	146.54	2.02	1.40	1.62	3.13	2.59	2.49
10.0	230.78	196.14	164.75	2.15	1.65	1.44	3.01	2.70	2.38
12.0	258.19	224.89	193.95	2.12	2.05	1.29	2.60	2.84	2.29
14.0	277.70	243.96	214.97	1.94	2.24	1.41	2.20	2.84	2.35
15.0	285.95	251.62	223.46	1.84	2.28	1.52	2.04	2.80	2.40

\* Normalized at control voltage = 0V

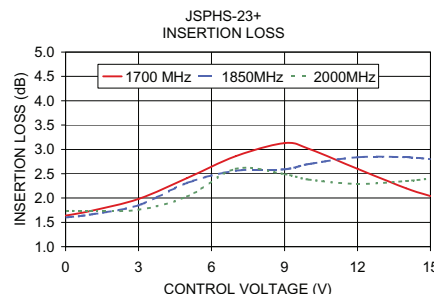
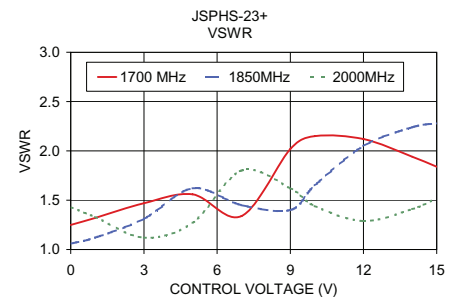
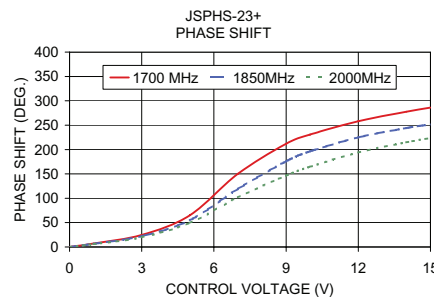

### electrical schematic

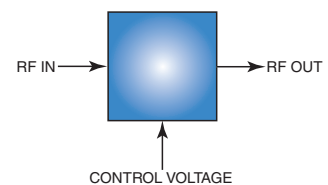

### Notes

- Performance and quality attributes and conditions not expressly stated in this specification document are intended to be excluded and do not form a part of this specification document.
- Electrical specifications and performance data contained in this specification document are based on Mini-Circuit's applicable established test performance criteria and measurement instructions.
- The parts covered by this specification document are subject to Mini-Circuits standard limited warranty and terms and conditions (collectively, "Standard Terms"); Purchasers of this part are entitled to the rights and benefits contained therein. For a full statement of the Standard Terms and the exclusive rights and remedies thereunder, please visit Mini-Circuits' website at [www.minicircuits.com/MCLStore/terms.jsp](http://www.minicircuits.com/MCLStore/terms.jsp)

