

Coaxial

Voltage Controlled Oscillator

ZX95-2952A+

5V Tuning for PLL IC's 2748 to 2952 MHz

Features

- low phase noise
- low pulling
- low pushing
- protected by US patent 6,790,049



CASE STYLE: GB956

Applications

- r & d
- lab
- instrumentation
- wireless communications
- WiMAX

Connectors	Model	Price	Qty.
SMA	ZX95-2952A-S+	\$44.95 ea.	(1-9)

+RoHS Compliant
The +Suffix identifies RoHS Compliance. See our web site for RoHS Compliance methodologies and qualifications

Electrical Specifications

MODEL NO.	FREQ. (MHz)		POWER OUTPUT (dBm)	PHASE NOISE dBc/Hz SSB at offset frequencies, kHz				TUNING					NON HARMONIC SPURIOUS (dBc)	HARMONICS (dBc)		PULLING pk-pk @ 12 dB (MHz)	PUSHING (MHz/V)	DC OPERATING POWER				
	Min.	Max.		Typ.	1	10	100	1000	VOLTAGE RANGE (V)		PORT CAP (pF)	3 dB MODULATION BANDWIDTH (MHz)		Typ.	Typ.			Max.	Typ.	Typ.	Vcc (volts)	Current (mA)
	Min.	Max.							Typ.	Typ.												
ZX95-2952A+	2748	2952	+4.3	-70	-98	-119	-139	0.5	4.5	84-89	25	40	-90	-25	-15	1.5	1.2	5	40			

Maximum Ratings

Operating Temperature	-55°C to 85°C
Storage Temperature	-55°C to 100°C
Absolute Max. Supply Voltage (Vcc)	7V
Absolute Max. Tuning Voltage (Vtune)	7V
All specifications	50 ohm system

Permanent damage may occur if any of these limits are exceeded.

Outline Drawing

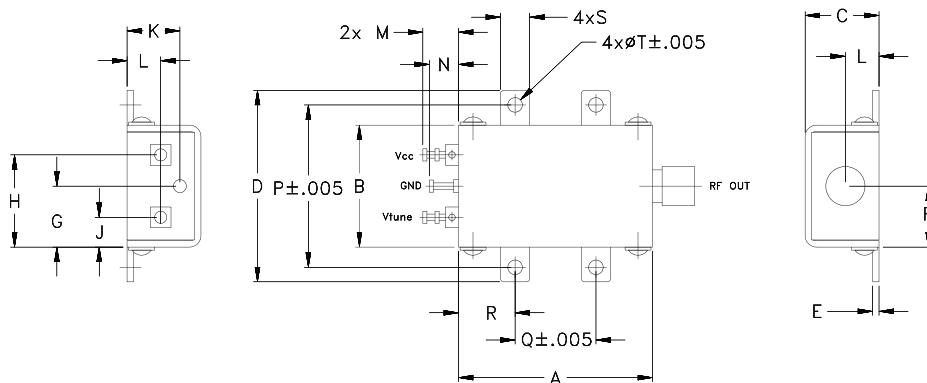

Outline Dimensions (inch/mm)

A	B	C	D	E	F	G	H	J	K	L	M	N	P	Q	R	S	T	wt.
1.20	.75	.46	1.18	.04	.38	.38	.57	.18	.33	.21	.22	.18	1.00	.50	.35	.18	.106	grams
30.48	19.05	11.68	29.97	1.02	9.65	9.65	14.48	4.57	8.38	5.33	5.59	4.57	25.40	12.70	8.89	4.57	2.69	35.0



For detailed performance specs & shopping online see web site

P.O. Box 350166, Brooklyn, New York 11235-0003 (718) 934-4500 Fax (718) 332-4661 The Design Engineers Search Engine Provides ACTUAL Data Instantly at minicircuits.com

Notes: 1. Performance and quality attributes and conditions not expressly stated in this specification sheet are intended to be excluded and do not form a part of this specification sheet. 2. Electrical specifications and performance data contained herein are based on Mini-Circuit's applicable established test performance criteria and measurement instructions. 3. The parts covered by this specification sheet are subject to Mini-Circuits standard limited warranty and terms and conditions (collectively, "Standard Terms"); Purchasers of this part are entitled to the rights and benefits contained therein. For a full statement of the Standard Terms and the exclusive rights and remedies thereunder, please visit Mini-Circuits' website at www.minicircuits.com/MCLStore/terms.jsp.

Performance Data & Curves*

ZX95-2952A+

V TUNE	TUNE SENS (MHz/V)	FREQUENCY (MHz)			POWER OUTPUT (dBm)			Icc (mA)	HARMONICS (dBc)			FREQ. PUSH (MHz/V)	FREQ. PULL (MHz)	PHASE NOISE (dBc/Hz) at offsets				FREQ OFFSET (KHz)	PHASE NOISE at 2850 MHz (dBc/Hz)
		-55°C	+25°C	+85°C	-55°C	+25°C	+85°C		F2	F3	F4			1kHz	10kHz	100kHz	1MHz		
0.00	120.48	2646.8	2629.9	2614.1	3.77	3.91	3.99	28.83	-23.9	-39.0	-42.8	4.62	1.64	-67.9	-95.3	-117.1	-137.3	1.0	-71.26
0.25	106.64	2675.3	2660.0	2645.9	3.87	3.98	4.09	28.88	-25.3	-39.5	-42.3	3.12	1.47	-68.8	-96.3	-118.3	-137.8	2.0	-79.43
0.50	98.39	2701.0	2686.7	2673.5	3.83	4.02	4.15	28.90	-25.4	-39.3	-41.6	2.28	1.84	-70.8	-96.8	-119.2	-139.1	3.5	-86.65
0.75	97.12	2726.1	2711.3	2698.7	3.62	3.97	4.13	28.89	-26.9	-39.5	-40.5	1.78	1.16	-69.0	-98.8	-119.3	-139.8	6.0	-92.56
1.00	90.53	2749.3	2735.6	2722.8	3.52	3.78	3.98	28.87	-25.9	-38.9	-40.2	1.41	1.66	-69.1	-97.4	-119.2	-139.4	8.5	-95.67
1.25	88.15	2771.6	2758.2	2746.2	3.71	3.75	3.86	28.92	-26.8	-39.3	-40.0	1.23	1.67	-70.6	-98.1	-119.5	-139.4	10.0	-97.78
1.50	87.14	2793.4	2780.2	2768.4	4.01	3.97	3.94	28.94	-27.1	-39.9	-38.9	1.13	1.56	-70.3	-98.0	-119.7	-139.5	20.8	-105.14
1.75	87.27	2815.3	2802.0	2790.1	4.00	4.18	4.18	28.96	-26.6	-39.7	-39.1	1.05	1.30	-71.3	-97.9	-119.8	-139.7	35.5	-110.07
2.00	88.19	2837.6	2823.8	2811.6	3.92	4.16	4.32	28.95	-27.0	-40.4	-38.2	1.01	2.22	-71.2	-96.6	-119.1	-139.3	60.7	-114.36
2.25	86.76	2859.3	2845.9	2833.8	3.97	4.11	4.23	29.00	-25.6	-39.8	-37.3	0.98	1.25	-71.7	-97.6	-119.4	-139.6	86.7	-118.18
2.50	86.90	2881.1	2867.6	2855.5	4.12	4.15	4.22	29.04	-27.2	-40.1	-37.4	1.04	1.82	-70.6	-97.7	-119.2	-139.2	100.0	-119.42
2.75	87.38	2902.9	2889.3	2877.1	4.19	4.30	4.29	29.09	-25.3	-40.5	-37.2	1.15	1.83	-71.3	-97.6	-119.1	-139.0	148.1	-122.75
3.00	86.98	2924.9	2911.2	2898.7	4.14	4.34	4.43	29.14	-25.2	-40.2	-36.3	1.32	1.71	-71.2	-97.1	-119.1	-138.9	177.0	-124.41
3.25	86.00	2946.7	2932.9	2920.5	4.23	4.30	4.43	29.21	-25.0	-40.5	-36.3	1.58	1.55	-69.7	-96.8	-119.1	-138.8	302.4	-128.83
3.50	85.95	2968.5	2954.4	2941.9	4.44	4.42	4.44	29.28	-24.4	-40.7	-36.0	1.98	1.91	-71.0	-96.8	-118.6	-138.5	361.5	-130.56
3.75	84.40	2990.0	2975.9	2963.2	4.68	4.64	4.60	29.32	-26.0	-39.7	-35.1	2.56	1.82	-68.7	-96.3	-118.5	-138.1	507.5	-133.52
4.00	82.22	3011.3	2997.0	2984.1	4.82	4.87	4.81	29.36	-25.7	-40.1	-35.2	3.28	1.01	-69.1	-95.4	-118.0	-138.7	606.7	-135.20
4.25	77.67	3031.4	3017.5	3004.5	4.82	4.94	5.00	29.40	-26.3	-37.4	-34.9	4.18	1.86	-68.2	-95.6	-117.8	-137.8	851.6	-137.85
4.50	75.13	3051.2	3037.0	3024.1	4.70	4.90	5.05	29.45	-26.2	-36.5	-34.0	5.04	1.69	-67.2	-95.2	-117.6	-137.9	1000.0	-139.06

*at 25°C unless mentioned otherwise

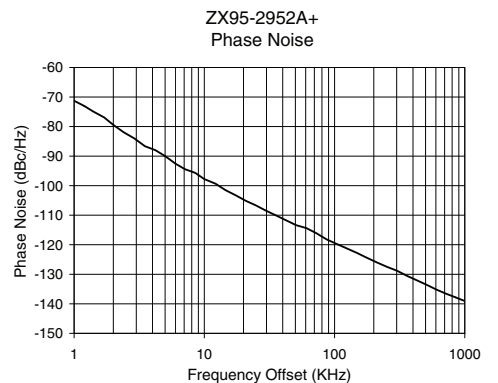
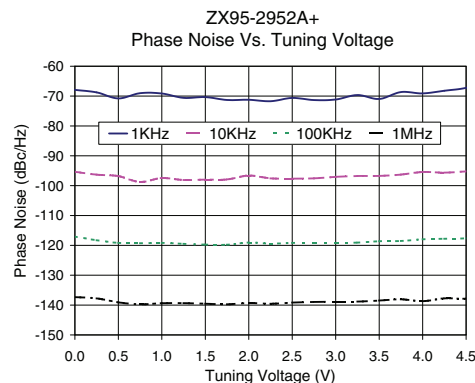
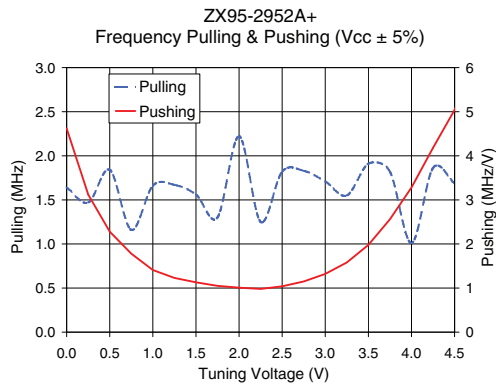
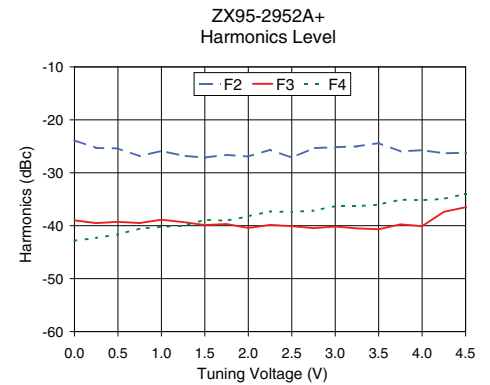
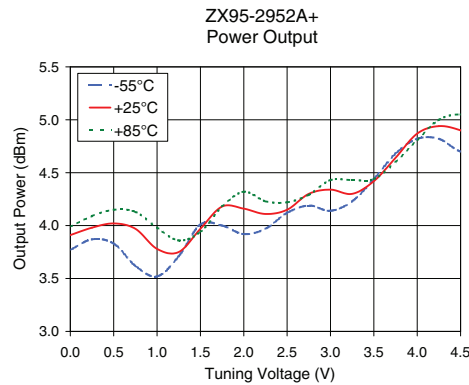
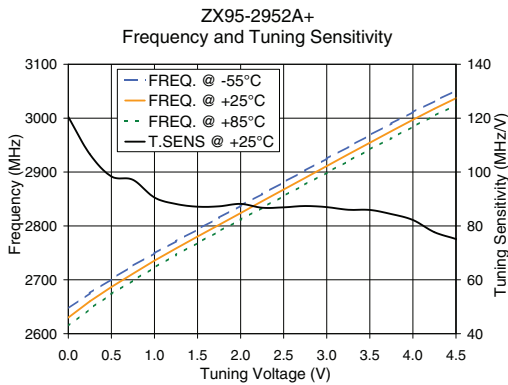

For detailed performance specs & shopping online see web site

P.O. Box 350166, Brooklyn, New York 11235-0003 (718) 934-4500 Fax (718) 332-4661 The Design Engineers Search Engine Provides ACTUAL Data Instantly at minicircuits.com

Notes: 1. Performance and quality attributes and conditions not expressly stated in this specification sheet are intended to be excluded and do not form a part of this specification sheet. 2. Electrical specifications and performance data contained herein are based on Mini-Circuit's applicable established test performance criteria and measurement instructions. 3. The parts covered by this specification sheet are subject to Mini-Circuits standard limited warranty and terms and conditions (collectively, "Standard Terms"); Purchasers of this part are entitled to the rights and benefits contained therein. For a full statement of the Standard Terms and the exclusive rights and remedies thereunder, please visit Mini-Circuits' website at www.minicircuits.com/MCLStore/terms.jsp.