

Surface Mount Voltage Controlled Oscillator

JTOS-400+ JTOS-400

Linear Tuning 200 to 380 MHz

Features

- wide frequency range
- linear tuning characteristics
- excellent harmonic suppression
- low phase noise

Applications

- PLL circuitry
- measurement instrumentation

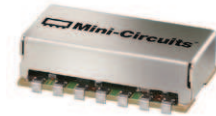

CASE STYLE: BK377
PRICE: \$ 15.95 ea. QTY (5-49)

+RoHS Compliant

The +Suffix identifies RoHS Compliance. See our web site for RoHS Compliance methodologies and qualifications

Electrical Specifications

FREQUENCY (MHz)		POWER OUTPUT (dBm)	TUNING VOLTAGE (V)		PHASE NOISE (dBc/Hz) SSB at offset frequencies: Typ.				PULLING pk-pk @ 12 dB (MHz)	PUSHING (MHz/V)	TUNING SENSITIVITY (MHz/V)	HARMONICS (dBc)		3 dB MODULATION BANDWIDTH (MHz)	DC OPERATING POWER	
Min.	Max.	Typ.	Min.	Max.	1 kHz	10 kHz	100 kHz	1 MHz	Typ.	Typ.	Typ.	Typ.	Max.	Typ.	Vcc (volts)	Current (mA) Max.
200	380	+9.0	1	16	-82	-102	-122	-142	1.4	0.4	10.5-17.1	-25	-20	0.13	12	20

Pin Connections

RF OUT	13
VCC	2
V-TUNE	5
GROUND	1,3,4,6,7,8,9,10,11,12,14

Maximum Ratings

Operating Temperature	-55°C to 85°C
Storage Temperature	-55°C to 100°C
Absolute Max. Supply Voltage (Vcc)	+16V
Absolute Max. Tuning Voltage (Vtune)	+18V

all specifications: 50 ohm system
Permanent damage may occur if any of these limits are exceeded.

Outline Drawing

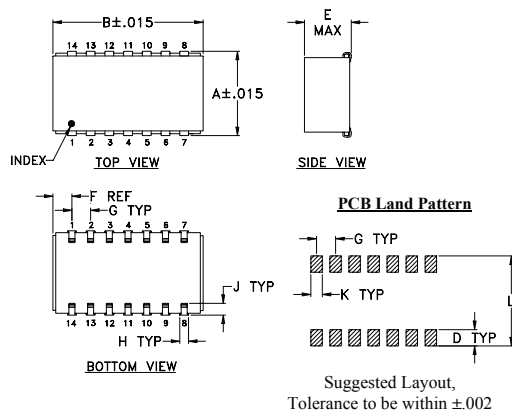

Demo Board MCL PIN: TB-04 Suggested PCB Layout (PL-005)

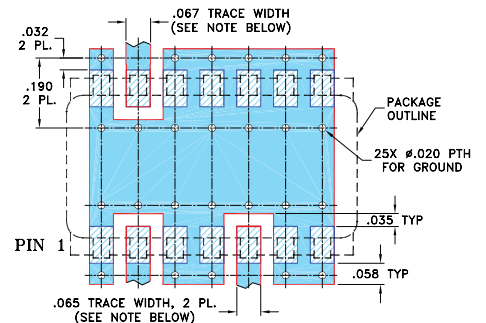

- NOTES: 1. TRACE WIDTH IS SHOWN FOR ROGERS R04350B WITH DIELECTRIC THICKNESS .030" ± .002"; COPPER: 1/2 OZ. EACH SIDE. FOR OTHER MATERIALS TRACE WIDTH MAY NEED TO BE MODIFIED.
2. BOTTOM SIDE OF THE PCB IS CONTINUOUS GROUND PLANE.

- DENOTES PCB COPPER LAYOUT WITH SMOBC (SOLDER MASK OVER BARE COPPER)
- DENOTES COPPER LAND PATTERN FREE OF SOLDER MASK

Outline Dimensions (inch/mm)

A	B	C	D	E	F	G	H	J	K	L	wt
.505	.800	--	.100	.250	.100	.100	.047	.065	.065	.525	grams
12.83	20.32	--	2.54	6.35	2.54	2.54	1.19	1.65	1.65	13.34	3.0

Notes

- A. Performance and quality attributes and conditions not expressly stated in this specification document are intended to be excluded and do not form a part of this specification document.
B. Electrical specifications and performance data contained in this specification document are based on Mini-Circuit's applicable established test performance criteria and measurement instructions.
C. The parts covered by this specification document are subject to Mini-Circuits standard limited warranty and terms and conditions (collectively, "Standard Terms"); Purchasers of this part are entitled to the rights and benefits contained therein. For a full statement of the Standard Terms and the exclusive rights and remedies thereunder, please visit Mini-Circuits' website at www.minicircuits.com/MCLStore/terms.jsp



Performance Data & Curves

JTOS-400+ JTOS-400

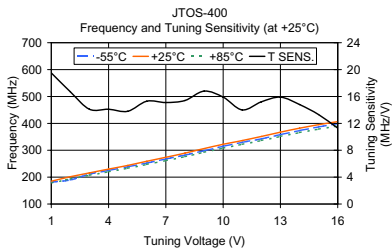

V TUNE	TUNING SENS. (MHz/V)	FREQUENCY (MHz)			POWER OUTPUT (dBm)		
		-55°C	+25°C	+85°C	-55°C	+25°C	+85°C
1.00	19.50	181.60	184.88	178.08	9.43	9.27	8.47
2.00	16.70	189.70	201.58	193.38	9.57	9.71	9.06
3.00	14.10	211.25	215.71	207.00	9.77	10.08	9.49
4.00	14.10	224.98	229.83	220.17	10.10	10.39	9.75
5.00	13.80	238.65	243.63	233.22	10.17	10.38	9.91
6.00	15.30	252.53	258.88	247.43	9.84	10.25	10.03
7.00	15.10	267.80	273.95	261.75	9.68	10.24	10.14
8.00	15.40	282.13	289.35	276.48	9.43	10.11	10.09
9.00	16.80	298.35	306.18	292.55	9.44	10.17	10.12
10.00	15.90	314.65	322.08	308.05	9.63	10.21	9.89
11.00	14.00	329.68	336.13	322.25	9.27	9.67	9.42
12.00	15.20	342.40	351.32	336.42	8.43	8.94	8.91
13.00	15.90	358.26	367.18	351.48	7.99	8.54	8.63
14.00	14.80	373.38	382.00	365.85	7.61	8.35	8.53
15.00	13.30	386.98	395.30	378.86	7.46	8.23	8.43
16.00	11.30	398.75	406.65	390.35	7.29	8.10	8.31

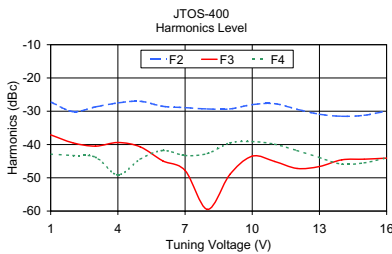
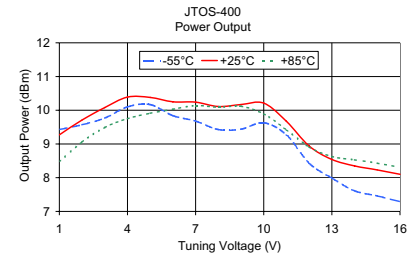

V TUNE	HARMONICS (dBc)			FREQ. PUSHING (MHz/V)
	F2	F3	F4	
1.00	-27.20	-37.10	-42.90	0.62
2.00	-30.10	-39.50	-43.30	0.28
3.00	-28.70	-40.50	-43.80	0.28
4.00	-27.50	-39.40	-49.10	0.10
5.00	-27.00	-40.70	-44.40	0.20
6.00	-28.50	-44.90	-41.80	0.17
7.00	-28.90	-47.80	-43.30	0.02
8.00	-29.30	-59.50	-42.70	0.41
9.00	-29.30	-49.00	-39.50	0.32
10.00	-28.00	-43.50	-39.10	0.18
11.00	-27.70	-45.10	-39.90	0.10
12.00	-29.40	-47.20	-41.80	0.62
13.00	-30.90	-46.60	-43.90	0.53
14.00	-31.50	-44.60	-45.90	0.42
15.00	-31.20	-44.40	-45.50	0.30
16.00	-29.90	-44.10	-44.00	0.20

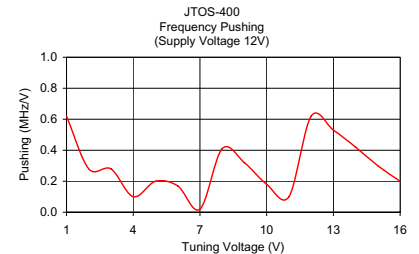

Notes

- A. Performance and quality attributes and conditions not expressly stated in this specification document are intended to be excluded and do not form a part of this specification document.
- B. Electrical specifications and performance data contained in this specification document are based on Mini-Circuits' applicable established test performance criteria and measurement instructions.
- C. The parts covered by this specification document are subject to Mini-Circuits standard limited warranty and terms and conditions (collectively, "Standard Terms"); Purchasers of this part are entitled to the rights and benefits contained therein. For a full statement of the Standard Terms and the exclusive rights and remedies thereunder, please visit Mini-Circuits' website at www.minicircuits.com/MCLStore/terms.jsp

