

Ceramic Low Pass Filter

50Ω DC⁽¹⁾ to 320 MHz

LFCN-320+ LFCN-320



CASE STYLE: FV1206
PRICE: \$2.99 ea. QTY (20)

+RoHS Compliant
The +Suffix identifies RoHS Compliance. See our web site for RoHS Compliance methodologies and qualifications

Available Tape and Reel at no extra cost
Reel Size: 7" Devices/Reel: 20, 50, 100, 200, 500, 1000, 3000

Maximum Ratings

Operating Temperature	-55°C to 100°C
Storage Temperature	-55°C to 100°C
RF Power Input*	8.5W max. at 25°C

* Passband rating, derate linearly to 3.5W at 100°C ambient. Permanent damage may occur if any of these limits are exceeded.

Pin Connections

RF IN	1
RF OUT	3
GROUND	2,4

Outline Drawing

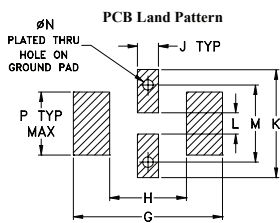
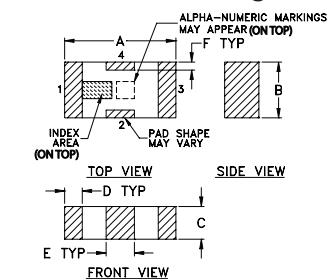

Suggested Layout, Tolerance to be within ±0.02

Outline Dimensions (inch/mm)

A	B	C	D	E	F	G	
.126	.063	.037	.020	.032	.009	.169	
3.20	1.60	0.94	0.51	0.81	0.23	4.29	
H	J	K	L	M	N	P	wt
.087	.024	.122	.024	.087	.012	.071	grams
2.21	0.61	3.10	0.61	2.21	0.30	1.80	.020

Demo Board MCL P/N: TB-270
Suggested PCB Layout (PL-137)

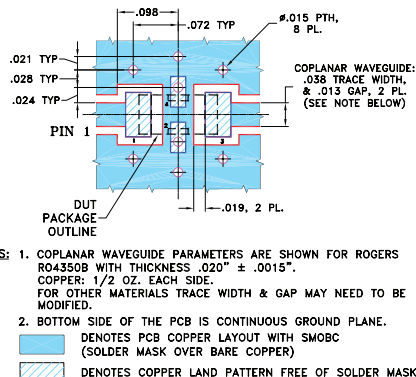

Features

- excellent power handling, 8.5W
- small size
- 7 sections
- temperature stable
- LTCC construction
- protected by U.S. Patent 6,943,646

Applications

- harmonic rejection
- VHF/UHF transmitters/receivers
- RF suppression for DC lines on PCB
- anti-aliasing for A/D converter

Electrical Specifications^(1,2) at 25°C

Parameter	F#	Frequency (MHz)	Min.	Typ.	Max.	Unit	
Pass Band	Insertion Loss	DC-F1	DC-320	—	—	1.0	dB
	Freq. Cut-Off	F2	460	—	3.0	—	dB
	VSWR	DC-F1	DC-320	—	1.2	—	:1
Stop Band	Rejection Loss	F3	560	20	—	—	dB
		F4-F5	640-2500	—	40	—	dB
		F6	5300	—	20	—	dB
VSWR	F3-F6	560-5300	—	20	—	:1	

(1) In Application where DC voltage is present at either input or output ports, coupling capacitors are required. Alternatively, if DC pass IN-OUT is required, Mini-Circuits' "D" suffix version of this model will support DC IN-OUT, and provide >100 MOhm isolation to ground.

(2) Measured on Mini-Circuits Characterization Test Board TB-270.

Typical Frequency Response

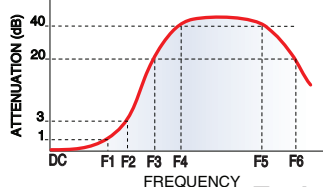

Electrical Schematic

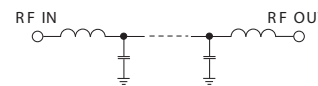

Typical Performance Data at 25°C

Frequency (MHz)	Insertion Loss (dB)	VSWR (:1)
1.00	0.09	1.02
100.00	0.30	1.06
320.00	0.78	1.14
360.00	0.99	1.26
460.00	2.60	2.03
535.00	15.40	8.90
560.00	27.43	13.29
580.00	40.10	15.53
640.00	48.87	19.98
1100.00	46.62	44.55
1500.00	48.50	59.91
2500.00	53.58	62.05
3500.00	40.54	59.91
5300.00	25.47	31.03
6000.00	24.68	25.19

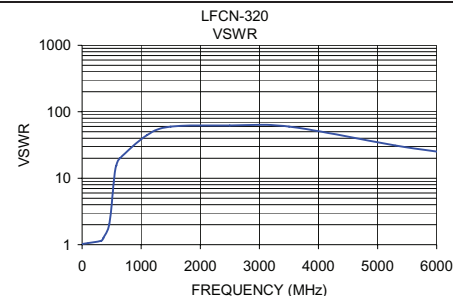
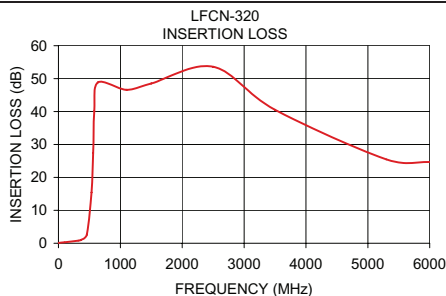

Notes

- A. Performance and quality attributes and conditions not expressly stated in this specification document are intended to be excluded and do not form a part of this specification document.
- B. Electrical specifications and performance data contained in this specification document are based on Mini-Circuit's applicable established test performance criteria and measurement instructions.
- C. The parts covered by this specification document are subject to Mini-Circuits standard limited warranty and terms and conditions (collectively, "Standard Terms"); Purchasers of this part are entitled to the rights and benefits contained therein. For a full statement of the Standard Terms and the exclusive rights and remedies thereunder, please visit Mini-Circuits' website at www.minicircuits.com/MCLStore/terms.jsp

