

Surface Mount Bandpass Filter

SYBP-1420+

50Ω 1250 to 1560 MHz



CASE STYLE: TT1423
PRICE: \$9.95 ea. QTY (10)

Features

- High power handling, 7W
- Small size
- Temperature stable
- Excellent rejection

Applications

- Military radio
- Cellular
- GSM
- ISM

Electrical Specifications at 25°C

Parameter	F#	Frequency (MHz)	Min.	Typ.	Max.	Unit	
Pass Band	Center Frequency	—	—	1420	—	MHz	
	Insertion Loss	F1-F2	1250 - 1560	—	2.2	2.9	dB
	VSWR	F1-F2	1250 - 1560	—	1.7	2.2	:1
Stop Band, Lower	Insertion Loss	DC-F3	DC - 910	20	24	—	dB
	VSWR	DC-F3	DC - 910	—	20	—	:1
Stop Band, Upper	Insertion Loss	F4-F5	2000 - 5000	20	25	—	dB
	VSWR	F4-F5	2000 - 5000	—	10	—	:1

Maximum Ratings

Operating Temperature	-40°C to 85°C
Storage Temperature	-55°C to 100°C
RF Power Input	7W* max. at 25°C

*Passband rating, derate linearly to 3W at 85°C ambient
Permanent damage may occur if any of these limits are exceeded.

Functional Schematic

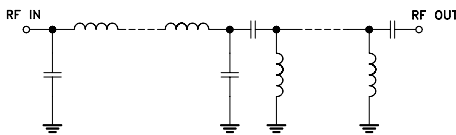

Typical Frequency Response

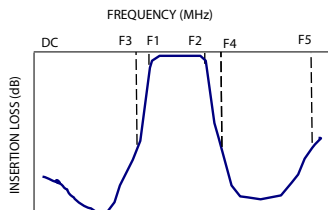

Typical Performance Data at 25°C

Frequency (MHz)	Insertion Loss (dB)	VSWR (:1)
1.00	92.10	7043.23
500.00	48.62	20.02
700.00	42.08	16.67
910.00	25.20	13.11
1000.00	15.22	9.33
1250.00	2.27	1.72
1300.00	2.11	1.65
1400.00	1.91	1.44
1560.00	2.16	1.68
1700.00	4.94	2.96
1800.00	10.68	6.28
1900.00	20.03	9.67
2000.00	33.70	11.49
3000.00	36.90	16.14
4000.00	35.26	28.97
5000.00	30.60	21.62

+ RoHS compliant in accordance with EU Directive (2002/95/EC)

The +Suffix has been added in order to identify RoHS Compliance.
See our web site for RoHS Compliance methodologies and qualifications.

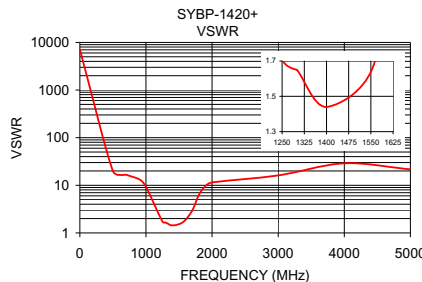
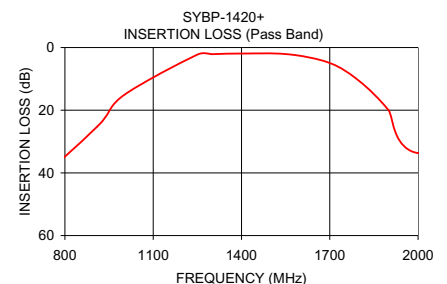
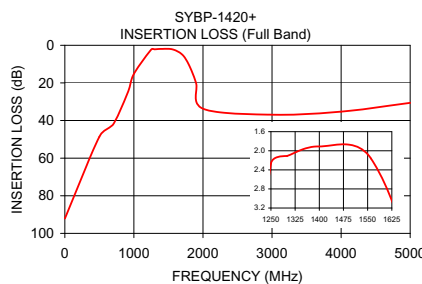

Mini-Circuits®
ISO 9001 ISO 14001 AS 9100 CERTIFIED
IFIRF MICROWAVE COMPONENTS

For detailed performance specs & shopping online see web site

P.O. Box 350166, Brooklyn, New York 11235-0003 (718) 934-4500 Fax (718) 332-4661 The Design Engineers Search Engine Provides ACTUAL Data Instantly at minicircuits.com

Notes: 1. Performance and quality attributes and conditions not expressly stated in this specification sheet are intended to be excluded and do not form a part of this specification sheet. 2. Electrical specifications and performance data contained herein are based on Mini-Circuit's applicable established test performance criteria and measurement instructions. 3. The parts covered by this specification sheet are subject to Mini-Circuits standard limited warranty and terms and conditions (collectively, "Standard Terms"); Purchasers of this part are entitled to the rights and benefits contained therein. For a full statement of the Standard Terms and the exclusive rights and remedies thereunder, please visit Mini-Circuits' website at www.minicircuits.com/MCLStore/terms.jsp.

REV. OR
M128407
SYBP-1420+
ED-13680/8
WZC/P/AM
110726
Page 2 of 3



Pin Connections

RF IN	4
RF OUT	6
GROUND	1,2,3,5

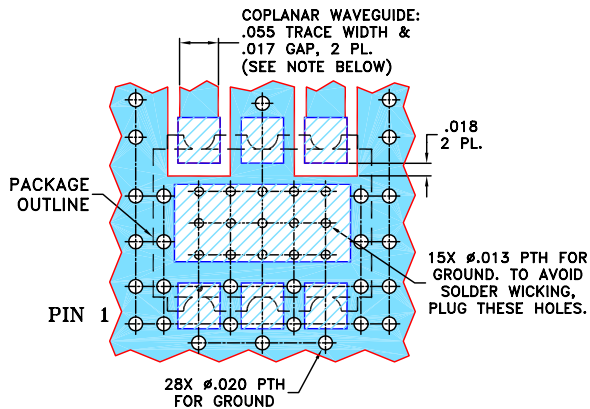
Demo Board MCL P/N: TB-517+
Suggested PCB Layout (PL-308)



NOTES:

- COPLANAR WAVEGUIDE PARAMETERS ARE SHOWN FOR ROGERS R04350B WITH THICKNESS $.030 \pm .002$; COPPER: 1/2 OZ. EACH SIDE. FOR OTHER MATERIALS TRACE WIDTH AND GAP MAY NEED TO BE MODIFIED.
 - BOTTOM SIDE OF THE PCB IS CONTINUOUS GROUND PLANE.
-  DENOTES PCB COPPER LAYOUT WITH SMOBC (SOLDER MASK OVER BARE COPPER)
-  DENOTES COPPER LAND PATTERN FREE OF SOLDER MASK

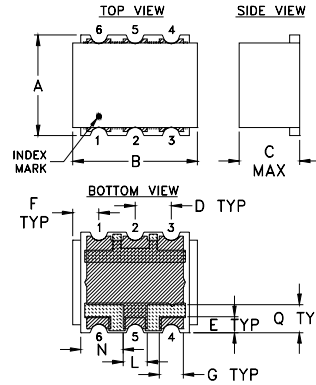

Outline Drawing

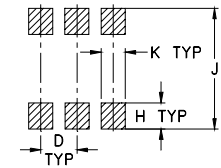

PCB Land Pattern



Suggested Layout,
Tolerance to be within $\pm .002$

 METALLIZATION
 SOLDER RESIST

Outline Dimensions (inch)

A	B	C	D	E	F	G	H
.25	.31	.15	.090	.040	.065	.060	.065
6.35	7.87	3.81	2.29	1.02	1.65	1.52	1.65
J	K	L	N	Q	wt.		
.300	.060	.060	.105	.070	grams		
7.62	1.52	1.52	2.67	1.78	0.50		