

Surface Mount Bandpass Filter

CBP-1400E+

50Ω 1320 to 1480 MHz

The Big Deal

- Low-profile shielded package
- Low passband Insertion Loss
- Excellent Rejection



CASE STYLE: LW1611

Product Overview

CBP-1400E+ is a ceramic-coaxial-resonator based bandpass filter in a shielded package (size of 0.638" x 0.434" x 0.105") fabricated using SMT technology. This filter offers outstanding close in rejection, low insertion loss and high power handling for use in broadband, fixed wireless, image rejection and point-to-point radio. In addition, this model uses low profile resonators which gives very good size advantage.

Key Features

Feature	Advantages
High Selectivity	The CBP-1400E+ filter incorporates High-Q ceramic resonators that enables sharp rejection near passband.
Low Passband VSWR	This filter maintains typical VSWR over a wide passband frequency range making this filter easier to integrate into receiver and transmitter RF chains with less concerns for in band frequency ripple.
Rugged construction	The CBP-1400E+ has been qualified over wide range of thermal, mechanical and environmental conditions including withstanding the stress of extensive solder reflow cycles.

Notes

- A. Performance and quality attributes and conditions not expressly stated in this specification document are intended to be excluded and do not form a part of this specification document.
B. Electrical specifications and performance data contained in this specification document are based on Mini-Circuit's applicable established test performance criteria and measurement instructions.
C. The parts covered by this specification document are subject to Mini-Circuits standard limited warranty and terms and conditions (collectively, "Standard Terms"); Purchasers of this part are entitled to the rights and benefits contained therein. For a full statement of the Standard Terms and the exclusive rights and remedies thereunder, please visit Mini-Circuits' website at www.minicircuits.com/MCLStore/terms.jsp



Surface Mount Bandpass Filter

CBP-1400E+

50Ω 1320 to 1480 MHz



CASE STYLE: LW1611
PRICE: \$34.95 ea. QTY (1-9)

Features

- Low Insertion loss
- Minimal Insertion loss variation over operating temperature
- Low-profile shielded package

Applications

- Wireless medical telemetry
- Satellite digital audio broad casting
- Aeronautical radio navigation

Electrical Specifications at 25°C

Parameter	F#	Frequency (MHz)	Min.	Typ.	Max.	Unit
Pass Band	Center Frequency	—	—	1400	—	MHz
	Insertion Loss	F1-F2	1320-1480	1.7	3	dB
	VSWR	F1-F2	1320-1480	—	1.5	2.3
Stop Band, Lower	Insertion Loss	DC-F3	DC-1150	20	42	dB
	VSWR	DC-F3	DC-1150	—	36	—
Stop Band, Upper	Insertion Loss	F4-F5	1600-2400	20	31	dB
	VSWR	F4-F5	1600-2400	—	20	—

Maximum Ratings

Operating Temperature	-40°C to 85°C
Storage Temperature	-55°C to 100°C
RF Power Input*	12.6W max. at 25°C

* Derate linearly to 6.5W at 85°C
Permanent damage may occur if any of these limits are exceeded.

Functional Schematic

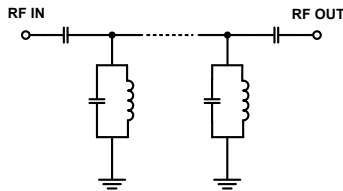

Typical Frequency Response

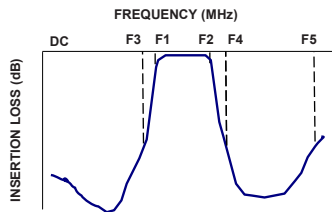

Typical Performance Data at 25°C

Frequency (MHz)	Insertion Loss (dB)	VSWR (:1)	Frequency (MHz)	Group Delay (nsec)
1	99.11	1737.18	1320	6.30
800	66.14	69.49	1330	6.06
1150	46.82	40.41	1340	5.86
1160	43.30	38.61	1350	5.69
1180	36.06	32.18	1360	5.55
1200	28.23	24.83	1370	5.43
1220	19.30	15.67	1380	5.36
1240	9.28	5.85	1390	5.33
1320	1.56	1.07	1395	5.33
1400	1.41	1.27	1400	5.34
1480	1.58	1.02	1405	5.36
1530	5.42	3.36	1410	5.39
1540	9.03	6.28	1420	5.45
1550	13.22	10.37	1425	5.48
1575	23.49	20.70	1430	5.52
1600	32.78	28.49	1440	5.59
1610	36.45	31.03	1450	5.71
1650	54.03	39.49	1460	5.88
2000	54.44	59.91	1470	6.14
2400	60.59	54.29	1480	6.49

+RoHS Compliant
The +Suffix identifies RoHS Compliance. See our web site for RoHS Compliance methodologies and qualifications

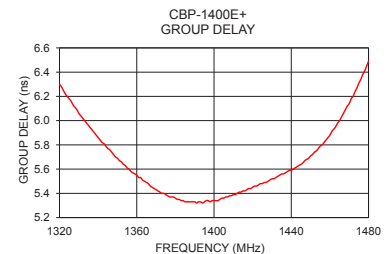
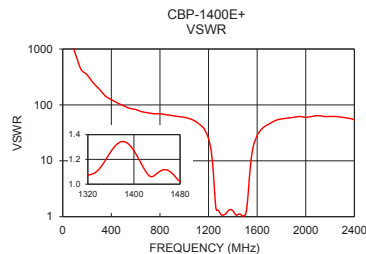
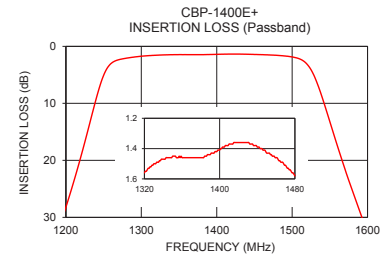
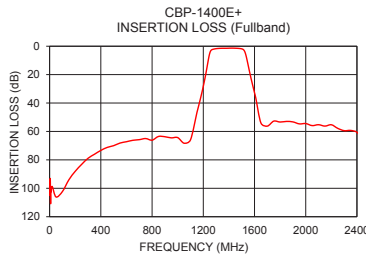

Notes

- Performance and quality attributes and conditions not expressly stated in this specification document are intended to be excluded and do not form a part of this specification document.
- Electrical specifications and performance data contained in this specification document are based on Mini-Circuit's applicable established test performance criteria and measurement instructions.
- The parts covered by this specification document are subject to Mini-Circuits standard limited warranty and terms and conditions (collectively, "Standard Terms"); Purchasers of this part are entitled to the rights and benefits contained therein. For a full statement of the Standard Terms and the exclusive rights and remedies thereunder, please visit Mini-Circuits' website at www.minicircuits.com/MCLStore/terms.jsp



Pad Connections

INPUT	1
OUTPUT	11
GROUND	2,3,4,5,6,7,8,9,10,12,13,14,15,16

Demo Board MCL P/N: TB-611+
Suggested PCB Layout (PL-338)

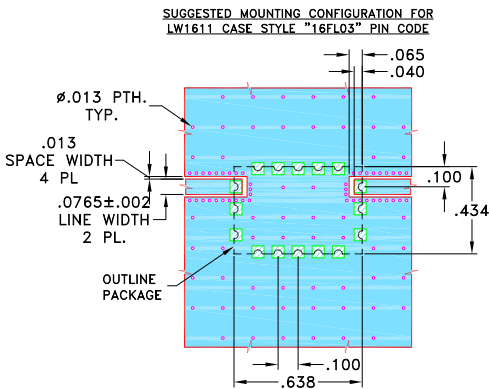

- NOTES:**
- TRACE WIDTH IS SHOWN FOR ROGERS R04350B WITH DIELECTRIC THICKNESS .060"±.004". COPPER: 1/2 OZ. EACH SIDE. FOR OTHER MATERIALS TRACE WIDTH MAY NEED TO BE MODIFIED.
 - BOTTOM SIDE OF THE PCB IS CONTINUOUS GROUND PLANE.

- DENOTES PCB COPPER LAYOUT WITH SMOBC (SOLDER MASK OVER BARE COPPER)
- DENOTES COPPER LAND PATTERN FREE OF SOLDERMASK

Outline Drawing

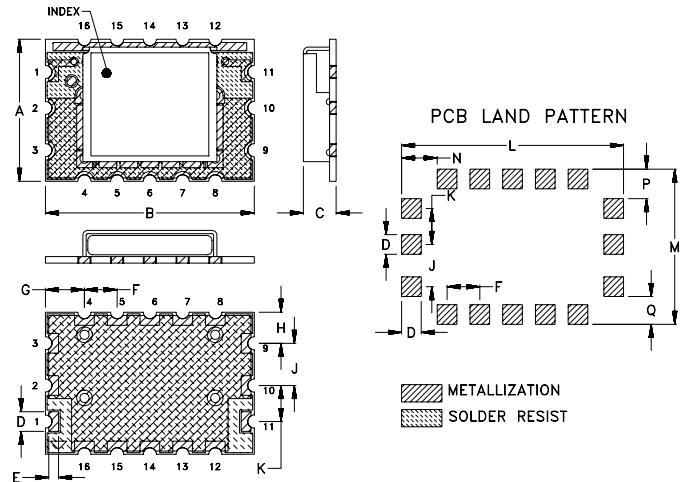

Outline Dimensions (inch / mm)

A	B	C	D	E	F	G	H	J	K	L	M
.434	.638	.120	.060	.030	.100	.119	.095	.129	.110	.678	.474
11.02	16.21	3.05	1.52	0.76	2.54	3.02	2.41	3.28	2.79	17.22	12.04
N	P	Q	wt,								
.109	.090	.085	grams								
2.77	2.29	2.16	0.8								

Notes

- Performance and quality attributes and conditions not expressly stated in this specification document are intended to be excluded and do not form a part of this specification document.
- Electrical specifications and performance data contained in this specification document are based on Mini-Circuit's applicable established test performance criteria and measurement instructions.
- The parts covered by this specification document are subject to Mini-Circuits standard limited warranty and terms and conditions (collectively, "Standard Terms"); Purchasers of this part are entitled to the rights and benefits contained therein. For a full statement of the Standard Terms and the exclusive rights and remedies thereunder, please visit Mini-Circuits' website at www.minicircuits.com/MCLStore/terms.jsp