

## ULTRA LOW CAPACITANCE STEERING DIODE/TVS ARRAY



**DFN-8 PACKAGE**

### DESCRIPTION

The PLR0506 is an ultra low capacitance steering diode/TVS array. This device is designed to protect computing applications such as gigabit Ethernet, HDMI, USB(1.0-3.0) and DVI interfaces as well as telecommunication equipment and systems. The PLR0506 is available in the space-saving DFN-8 package configuration.

This device meets the IEC 61000-4-2 (ESD), 61000-4-2 (EFT) and 61000-4-4 (Surge) requirements. At higher operating frequencies or faster edge rates, insertion loss and signal integrity are a major concern. This device in conjunction with passive components integrated into a TVS/filter network can be used for EMI/RFI protection.

### FEATURES

- Compatible with IEC 61000-4-2 (ESD): Air - 15kV, Contact - 8kV
- Compatible with IEC 61000-4-4 (EFT): 40A - 5/50ns
- Compatible with IEC 61000-4-5 (Lightning): 4A - 8/20 $\mu$ s
- ESD Protection > 25 kilovolts
- Low Clamping Voltage
- Protects 6 Lines
- Ultra Low Capacitance : 0.4pF Typical(I/O to I/O)
- RoHS Compliant
- REACH Compliant

### APPLICATIONS

- Gigabit Ethernet
- DVI and HDMI Interfaces
- High-Speed Data Line ESD Protection
- FireWire, SATA & PCIe Interfaces
- USB 1.0, USB 2.0 & USB 3.0

### MECHANICAL CHARACTERISTICS

- Molded JEDEC DFN-8 Package
- Approximate Weight: 7 milligrams
- Lead-Free Pure-Tin Plating (Annealed)
- Solder Reflow Temperature:  
Pure-Tin - Sn, 100: 260-270°C
- 8mm Tape and Reel Per EIA Standard 481
- Flammability Rating UL 94V-0

### CIRCUIT DIAGRAM & PIN CONFIGURATION

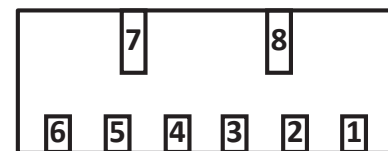
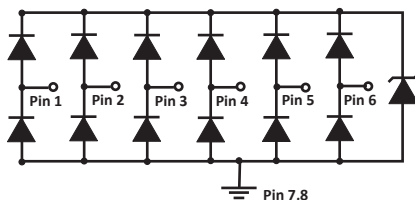

**BOTTOM VIEW**

**TYPICAL DEVICE CHARACTERISTICS**
**MAXIMUM RATINGS @ 25°C Unless Otherwise Specified**

PARAMETER	SYMBOL	VALUE	UNITS
Peak Pulse Current	$I_{PP}$	4	Amps
Operating Temperature	$T_L$	-55 to 150	°C
Storage Temperature	$T_{STG}$	-55 to 150	°C

**ELECTRICAL CHARACTERISTICS PER LINE @ 25°C Unless Otherwise Specified**

PART NUMBER	DEVICE MARKING	RATED STAND-OFF VOLTAGE $V_{WM}$ VOLTS	MINIMUM BREAKDOWN VOLTAGE (Note 1) @ 1mA $V_{(BR)}$ VOLTS	MAXIMUM CLAMPING VOLTAGE (Fig. 2) (Note 1) @ $I_p = 1A$ $V_C$ VOLTS	MAXIMUM CLAMPING VOLTAGE (Fig. 2) (Note 1) @ $I_p = 4A$ $V_C$ VOLTS	MAXIMUM LEAKAGE CURRENT (Note 1) @ $V_{WM}$ $I_D$ $\mu A$	TYPICAL CAPACITANCE (Note 1) @ 0V, 1MHz $C_{J(SD)}$ pF
PLR0506	506	5.0	6.0	15.0	18.0	3	0.8

**NOTE**

1. From I/O Pin to ground.

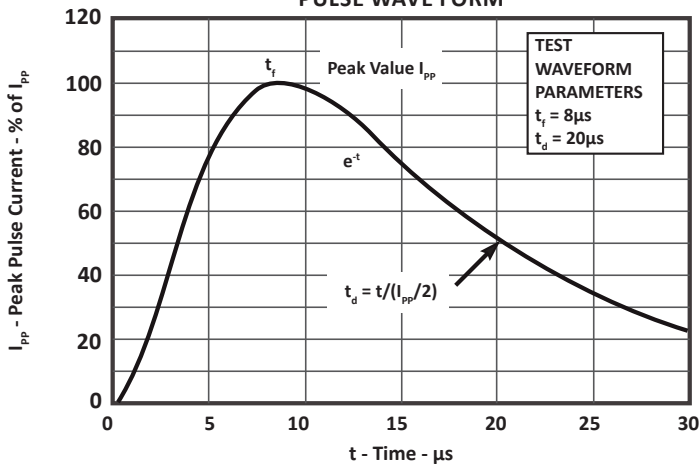
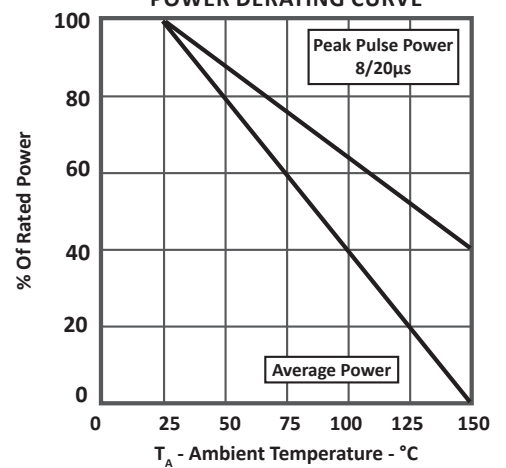
**FIGURE 2  
PULSE WAVE FORM**

**FIGURE 3  
POWER DERATING CURVE**

## DFN-8 PACKAGE INFORMATION

## OUTLINE DIMENSIONS

DIM	MILLIMETERS		INCHES	
	MIN	MAX	MIN	MAX
A	3.224	3.376	0.127	0.133
B	1.224	1.376	0.048	0.054
C	1.250		0.049	
D	0.544	0.696	0.021	0.133
E	0.200	-	0.008	-
F	0.200	0.300	0.008	0.012
G	0.500		0.020	
H	0.304	0.456	0.012	0.018
J	0.543	0.550	0.0214	0.0217
K	0.000	0.050	0.000	0.002
L	0.127		0.005	

## NOTES

1. Controlling dimension: millimeters.

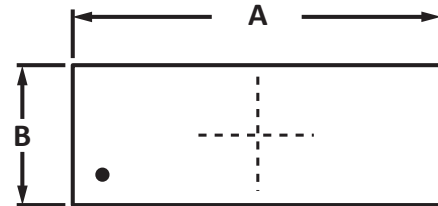

TOP VIEW

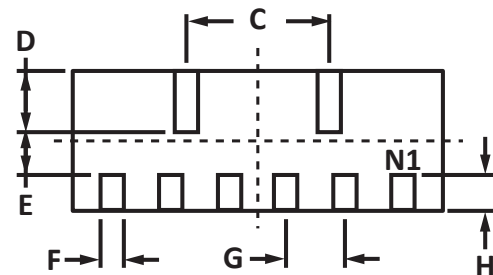

BOTTOM VIEW

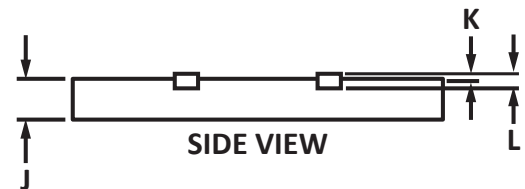

SIDE VIEW

## PAD LAYOUT DIMENSIONS

DIM	MILLIMETERS	INCHES
	NOMINAL	NOMINAL
C	1.05	0.041
G	0.25	0.010
P	0.50	0.020
P1	1.25	0.049
X	0.30	0.012
Y	0.68	0.027
Y1	0.92	0.036
Z	1.85	0.073

## NOTES

1. Controlling dimension: millimeters.

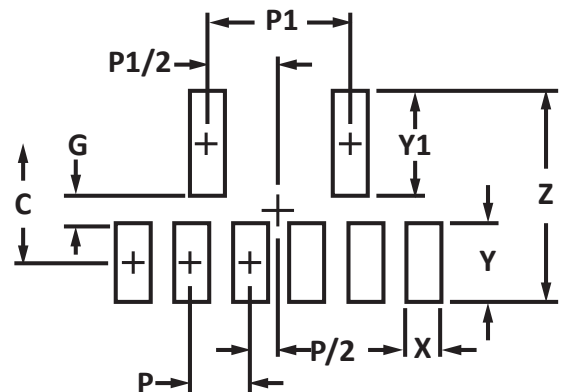

## TAPE AND REEL

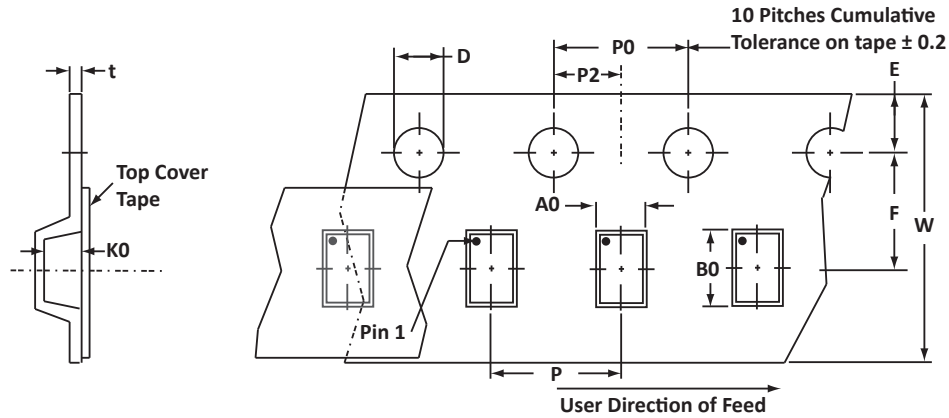

## SPECIFICATIONS

REEL DIA.	TAPE WIDTH	A0	B0	K0	D	E	F	W	P0	P2	P	tmax
178mm (7")	8mm	1.81 ± 0.10	3.51 ± 0.10	0.66 ± 0.10	1.50 ± 0.10	1.75 ± 0.10	3.50 ± 0.05	8.00 ± 0.30	4.00 ± 0.10	2.00 ± 0.05	4.00 ± 0.10	0.25

## NOTES

- Dimensions are in millimeters.
- Surface mount product is taped and reeled in accordance with EIA-481.
- Suffix - T73 = 7" Reel - 3,000 pieces per 8mm tape.
- Marking on Part - marking code (see page 2) and pin 1 dot.

## ORDERING INFORMATION

BASE PART NUMBER	LEADFREE SUFFIX	TAPE SUFFIX	QTY/REEL	REEL SIZE	TUBE QTY
PLR0506	n/a	-T73	3,000	7"	n/a

This device is only available in a Lead-Free configuration.

## COMPANY INFORMATION

---

### COMPANY PROFILE

In business more than 20 years, ProTek Devices™ is a privately held semiconductor company. The company offers a product line of overvoltage protection and overcurrent protection components. These include transient voltage suppressor array (TVS arrays) avalanche breakdown diode, steering diode TVS array and electronics SMD chip fuses. These components deliver circuit protection in electronic systems from numerous overvoltage and overcurrent events. They include lightning; electrostatic discharge (ESD); nuclear electromagnetic pulses (NEMP); inductive switching; and electromagnetic interference (EMI) / radio frequency interference (RFI). ProTek Devices also offers high performance interface and linear products. They include analog switches; multiplexers; LED drivers; LED wafer die for ESD protection; audio control ICs; RF and related high frequency products.

### CONTACT US

#### Corporate Headquarters

2929 South Fair Lane  
Tempe, Arizona 85282  
USA

#### By Telephone

General: 602-431-8101  
Sales: & Marketing: 602-414-5109  
Customer Service: 602-414-5114  
Product Technical Support: 602-414-5107

#### By Fax

General: 602-431-2288

#### By E-mail:

Sales: [sales@protekdevices.com](mailto:sales@protekdevices.com)  
Customer Service: [service@protekdevices.com](mailto:service@protekdevices.com)  
Technical Support: [support@protekdevices.com](mailto:support@protekdevices.com)

#### ProTek Devices (Asia Pacific) Pte. Ltd.

8 Ubi Road 2, #06-19  
Zervex  
Singapore - 408538  
Tel: +65-67488312  
Fax: +65-67488313

#### Web

[www.protekdevices.com](http://www.protekdevices.com)

COPYRIGHT © ProTek Devices 2012 - This literature is subject to all applicable copyright laws and is not for resale in any manner.

SPECIFICATIONS: ProTek reserves the right to change the electrical and or mechanical characteristics described herein without notice.

DESIGN CHANGES: ProTek reserves the right to discontinue product lines without notice and that the final judgement concerning selection and specifications is the buyer's and that in furnishing engineering and technical assistance. ProTek assumes no responsibility with respect to the selection or specifications of such products. ProTek makes no warranty, representation or guarantee regarding the suitability of its products for any particular purpose, nor does ProTek assume any liability arising out of the application or use of any product or circuit and specifically disclaims any and all liability without limitation special, consequential or incidental damages.

LIFE SUPPORT POLICY: ProTek Devices products are not authorized for use in life support systems without written consent from the factory.