

MINIATURE TVS ARRAY



DESCRIPTION

The PLW0501D is a transient voltage suppressor array (TVS) designed to protect applications such as wireless telecommunication devices, PCMCIA cards and portable electronics. The PLW0501D is available in a unidirectional configuration with a working voltage of 5.0V and a minimum breakdown voltage of 6.0V. This device is rated for 150 Watt peak pulse power using the 8/20 μ s waveform, which is sufficient protection for tertiary type lightning threats at key interface locations.

The PLW0501D is also suited to protect data lines against ESD and EFT. This device meets the IEC 61000-4-2 and IEC 61000-4 requirements. At higher operating frequencies or faster edge rates, insertion loss and signal integrity are a major concern. This device in conjunction with passive components integrated into a TVS/filter network can be used for EMI/RFI protection.

FEATURES

- Compatible with IEC 61000-4-2 (ESD): Air 15kV, Contact 8kV
- Compatible with IEC 61000-4-4 (EFT): 40A, 5/50ns
- 150 Watts Peak Pulse Power per Line ($t_p = 8/20\mu s$)
- ESD Protection > 25 kilovolts
- Cable Discharge Event (CDE) Protection
- Unidirectional Configuration
- Provides 1 Line of Protection
- RoHS Compliant
- REACH Compliant

APPLICATIONS

- Ethernet 10/100/1000 Base T
- SMART Phones
- Portable Electronics
- USB Interfaces

MECHANICAL CHARACTERISTICS

- Molded JEDEC DFN-2-0402 Package
- Approximate Weight: 0.8 milligrams
- Lead-Free Pure-Tin Plating (Annealed)
- Solder Reflow Temperature:
Pure-Tin - Sn, 100: 260-270°C
- 8mm Tape and Reel Per EIA Standard 481
- Flammability Rating UL 94V-0

PIN CONFIGURATION



TYPICAL DEVICE CHARACTERISTICS
MAXIMUM RATINGS @ 25°C Unless Otherwise Specified

PARAMETER	SYMBOL	VALUE	UNITS
Operating Temperature	T_A	-55 to 150	°C
Storage Temperature	T_{STG}	-55 to 150	°C
Peak Pulse Power (tp = 8/20μs) - See Figure 1	P_{PP}	150	Watts
Peak Pulse Current (tp = 8/20μs)	I_{PP}	10	A
Soldering Temperature for 10 seconds	T_L	265	°C
Typical Forward Voltage @ 10mA	V_F	0.8	V

ELECTRICAL CHARACTERISTICS PER LINE @ 25°C Unless Otherwise Specified

PART NUMBER	DEVICE MARKING	RATED STAND-OFF VOLTAGE V_{WM} VOLTS	MINIMUM BREAKDOWN VOLTAGE @ 1mA $V_{(BR)}$ VOLTS	MAXIMUM CLAMPING VOLTAGE (Fig. 2) @ $I_p = 1A$ V_C VOLTS	MAXIMUM LEAKAGE CURRENT @ V_{WM} I_D μA	TYPICAL CAPACITANCE @ 0V, 1MHz C pF
PLW0501D	4	5.0	6.0	9.8	1.0	70

FIGURE 1
PEAK PULSE POWER VS PULSE TIME

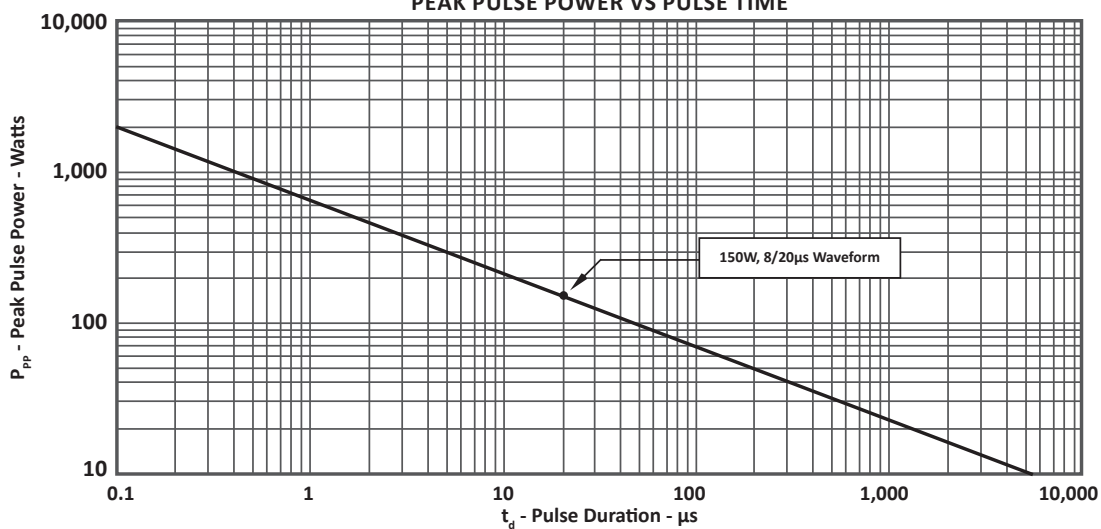

TYPICAL DEVICE CHARACTERISTICS

FIGURE 2
PULSE WAVE FORM

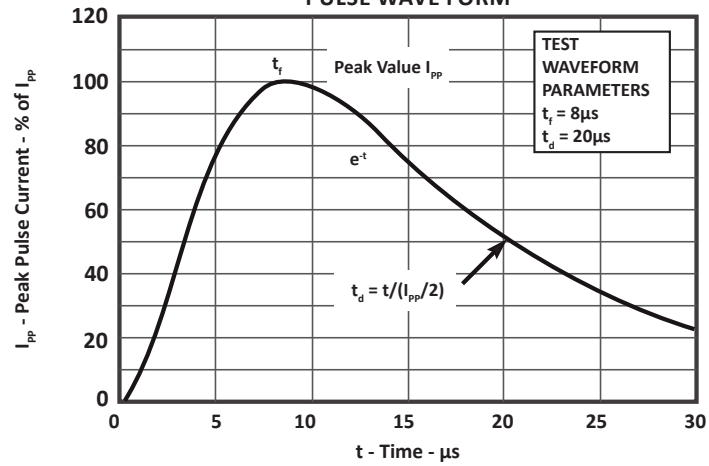
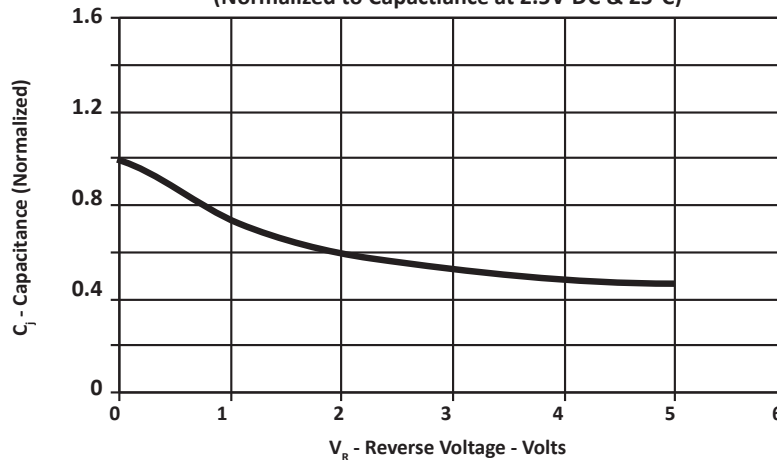

FIGURE 3
CAPACITANCE VS REVERSE VOLTAGE
(Normalized to Capacitance at 2.5V DC & 25°C)



TYPICAL DEVICE CHARACTERISTICS

FIGURE 4
8kV POSITIVE ESD CLAMPING WAVEFORM

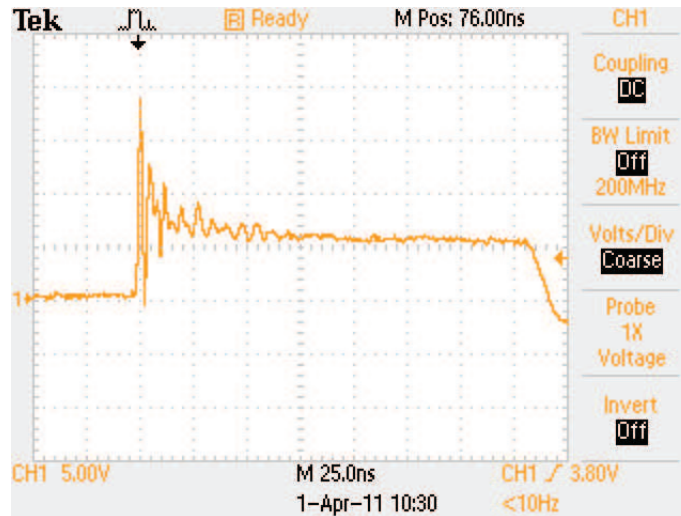
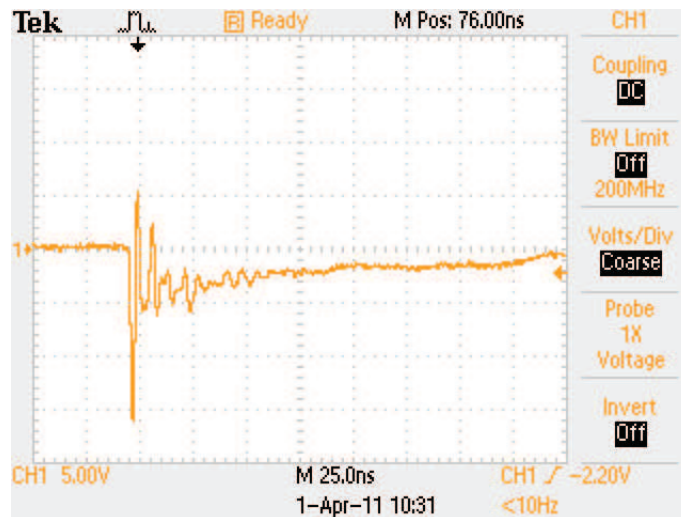

FIGURE 5
8kV NEGATIVE ESD CLAMPING WAVEFORM



DFN-2-0402 PACKAGE INFORMATION

OUTLINE DIMENSIONS

DIM	MILLIMETERS		INCHES	
	MIN	MAX	MIN	MAX
A	0.99	1.04	0.039	0.041
B	0.58	0.64	0.023	0.025
C	0.43	0.48	0.017	0.019
H	0.13	0.18	0.005	0.007
L1	0.28	0.33	0.011	0.013
L2	0.23	0.28	0.009	0.011
L3	0.23	0.28	0.009	0.011
L4	0.18	0.23	0.007	0.009

NOTES

1. Dimensioning and tolerances per ANSI Y14.M, 1985.
2. Controlling dimension: inches.

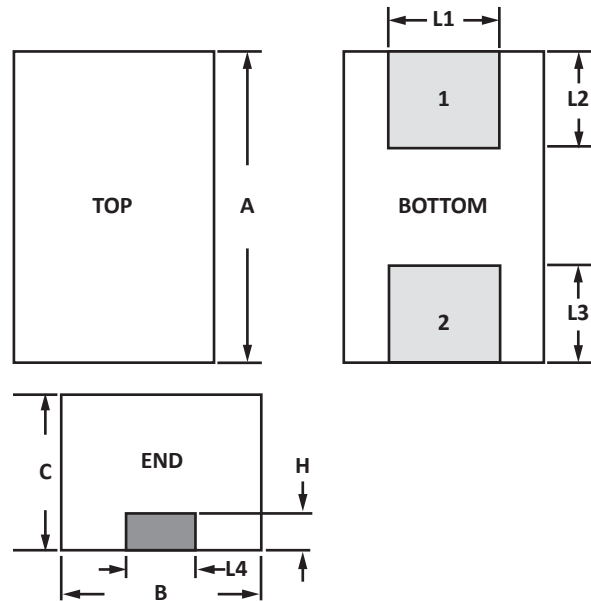

PAD LAYOUT DIMENSIONS

DIM	MILLIMETERS		INCHES	
	MIN	MAX	MIN	MAX
A	0.737	0.787	0.029	0.031
B	0.331	0.381	0.013	0.015
C	0.356	0.406	0.014	0.016
E	1.423	1.523	0.056	0.060
F	0.534	0.584	0.021	0.023

NOTES

1. Controlling dimension: inches.
2. Decimal tolerances for mounting pad: $\pm 0.003''$ (± 0.08 mm).

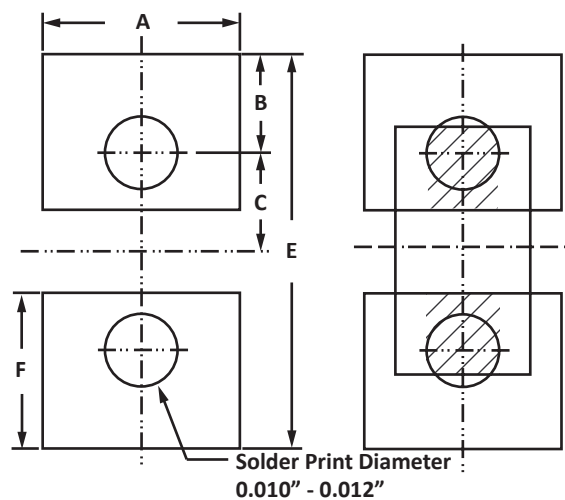

TAPE AND REEL

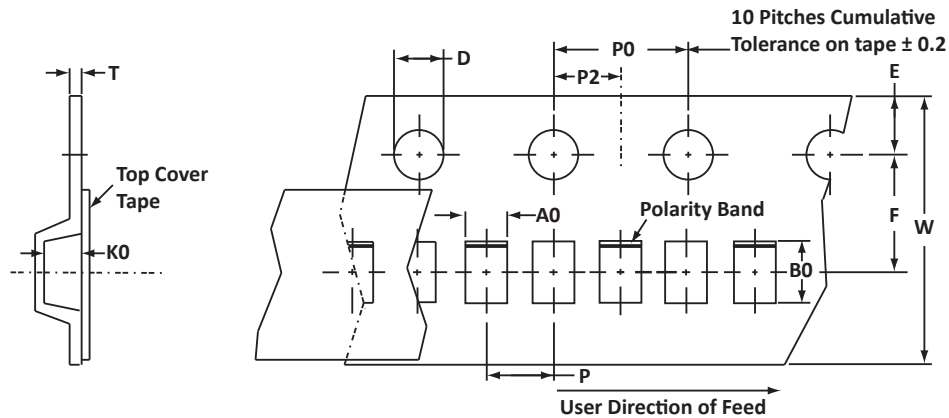

SPECIFICATIONS

REEL DIA.	TAPE WIDTH	A0	B0	K0	D	E	F	W	P0	P2	P	tmax
178mm (7")	8mm	0.70 ± 0.05	1.15 ± 0.05	0.60 ± 0.003	1.55 ± 0.10	1.75 ± 0.10	3.50 ± 0.05	8.00 ± 0.30	4.00 ± 0.10	2.00 ± 0.05	2.00 ± 0.05	0.25

NOTES

1. Dimensions are in millimeters.
2. Surface mount product is taped and reeled in accordance with EIA-481.
3. Empty pocket underneath sprocket holes.
4. Suffix - T73 = 7" Reel - 3,000 pieces per 8mm tape (sprocket hole skipped).
5. Marking on Part - marking code (see page 2) and polarity band.

Package outline, pad layout and tape specifications per document number 06094.R1 3/11 - Option 1.

ORDERING INFORMATION

BASE PART NUMBER	LEADFREE SUFFIX	TAPE SUFFIX	QTY/REEL	REEL SIZE	TUBE QTY
PLW0501D	-LF	-T73	3,000	7"	n/a

This device is only available in a Lead-Free configuration.

COMPANY INFORMATION

COMPANY PROFILE

In business more than 20 years, ProTek Devices™ is a privately-held company located in Tempe, Arizona, that offers a product line of transient voltage suppressors (TVS); avalanche breakdown diodes; steering diode TVS arrays and other surge suppressor component products. These TVS devices protect electronic systems from the effects of lightning, electrostatic discharge (ESD), nuclear electromagnetic pulses (NEMP), inductive switching and EMI / RFI. ProTek Devices also offers high performance interface and linear products that include analog switches; multiplexers; LED drivers; audio control ICs; RF and related high frequency products. The analog devices work in a host of consumer; industrial; automotive and other applications.

CONTACT US

Corporate Headquarters

2929 South Fair Lane
Tempe, Arizona 85282
USA

By Telephone

General: 602-431-8101
Sales: & Marketing: 602-414-5109
Customer Service: 602-414-5114
Product Technical Support: 602-414-5107

By Fax

General: 602-431-2288

By E-mail:

Sales: sales@protekdevices.com
Customer Service: service@protekdevices.com
Technical Support: support@protekdevices.com

ProTek Devices (Asia Pacific) Pte. Ltd.

8 Ubi Road 2, #06-19
Zervex
Singapore - 408538
Tel: +65-67488312
Fax: +65-67488313

Web

www.protekdevices.com

COPYRIGHT © ProTek Devices 2007 - This literature is subject to all applicable copyright laws and is not for resale in any manner.

SPECIFICATIONS: ProTek reserves the right to change the electrical and or mechanical characteristics described herein without notice.

DESIGN CHANGES: ProTek reserves the right to discontinue product lines without notice and that the final judgement concerning selection and specifications is the buyer's and that in furnishing engineering and technical assistance. ProTek assumes no responsibility with respect to the selection or specifications of such products. ProTek makes no warranty, representation or guarantee regarding the suitability of its products for any particular purpose, nor does ProTek assume any liability arising out of the application or use of any product or circuit and specifically disclaims any and all liability without limitation special, consequential or incidental damages.

LIFE SUPPORT POLICY: ProTek Devices products are not authorized for use in life support systems without written consent from the factory.