

MULTI-LINE LOW CAPACITANCE TVS ARRAY

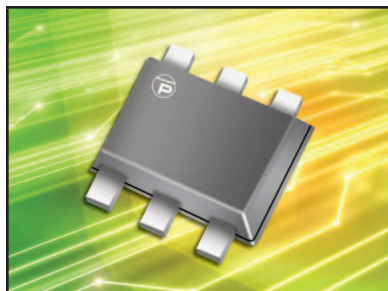

SOT-563 PACKAGE

DESCRIPTION

The PAM14ST6305LCC is a 5 Volt, low capacitance, multi-line TVS array. This device is designed to protect automotive applications from the damaging effects of ESD and EFT. The PAM14ST6305LCC is available in a 5 line unidirectional or 4 line bidirectional configuration with a working voltage of 5 Volts and a minimum breakdown voltage of 6 Volts. This device is rated at 25 Watts peak pulse power, which is sufficient protection for tertiary type lightning threats at key interface locations.

Packaged in a miniature SOT-563, the PAM14ST6305LCC meets IEC 61000-4-2 (ESD) and 61000-4-4 (EFT) immunity requirements. Each device should be placed near a connector to provide the best protection against transients.

FEATURES

- Compatible with IEC 61000-4-2 (ESD): Air 15kV, Contact 8kV
- Compatible with IEC 61000-4-4 (EFT): 40A, 5/50ns
- 25 Watts Peak Pulse Power per Line ($t_p = 8/20\mu s$)
- Monolithic Design
- Available in 5 Volts
- Low Clamping Voltage
- ESD Protection > 25 kilovolts
- Low Leakage Current
- Low Capacitance: 9pF
- Protects 4 Bidirectional Lines & 5 Unidirectional Lines
- RoHS Compliant
- REACH Compliant

APPLICATIONS

- Automotive Applications

MECHANICAL CHARACTERISTICS

- Molded JEDEC SOT-563 Package
- Approximate Weight: 3 milligrams
- Lead-Free Nickel Paladium Gold Plating
- Solder Reflow Temperature - 260-270°C
- Flammability Rating UL 94V-0
- 8mm Tape and Reel per EIA Standard 481

PIN CONFIGURATION

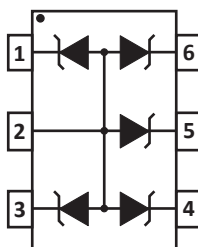

TYPICAL DEVICE CHARACTERISTICS
MAXIMUM RATINGS @ 25°C Unless Otherwise Specified

PARAMETER	SYMBOL	VALUE	UNITS
Peak Pulse Power (tp = 8/20μs) - See Figure 1	P _{PP}	25	Watts
Operating Temperature	T _L	-55 to 150	°C
Storage Temperature	T _{STG}	-55 to 150	°C
Maximum Forward Voltage @ 10mA	V _F	1.0	V

ELECTRICAL CHARACTERISTICS PER LINE @ 25°C Unless Otherwise Specified

PART NUMBER	DEVICE MARKING	RATED STAND-OFF VOLTAGE V _{WM} VOLTS	MINIMUM BREAKDOWN VOLTAGE @ 1mA V _(BR) VOLTS	MAXIMUM CLAMPING VOLTAGE (Fig. 2) @ I _P = 2A V _C VOLTS	MAXIMUM LEAKAGE CURRENT @V _{WM} I _D μA	TYPICAL CAPACITANCE (Note 1) @0V, 1MHz C pF
PAM14ST6305LCC	5LC	5.0	6.0	12.0	1	9

NOTES

1. Pins 1, 3, 4, 5 or 6 to pin 2.

TYPICAL DEVICE CHARACTERISTICS

FIGURE 1
PEAK PULSE POWER VS PULSE TIME

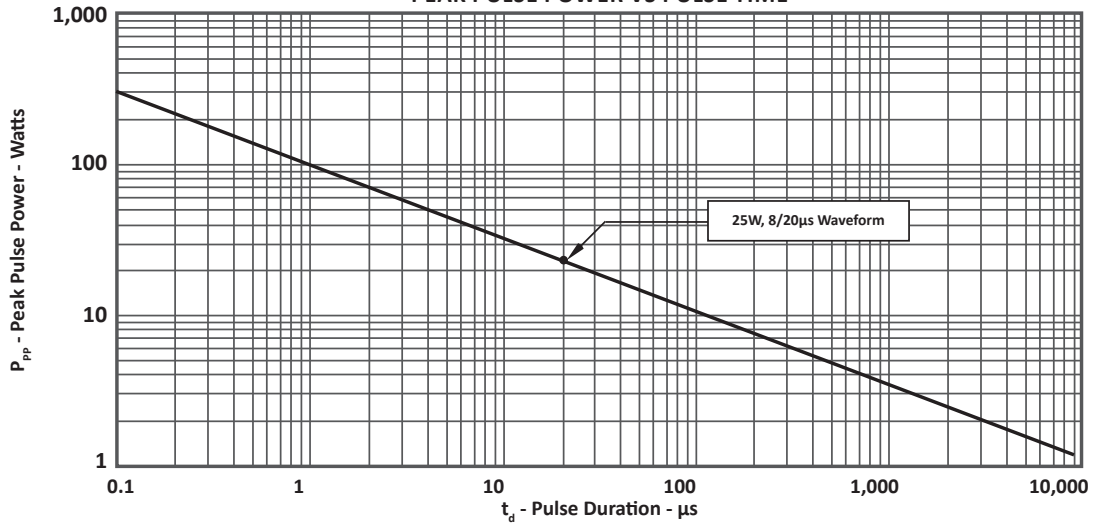

FIGURE 2
PULSE WAVE FORM

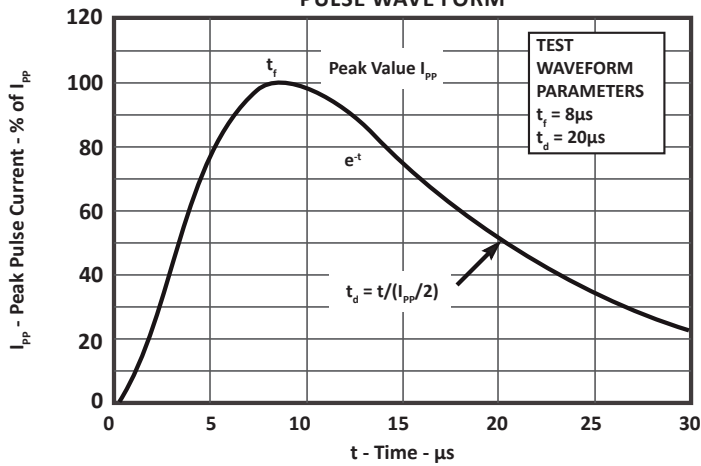
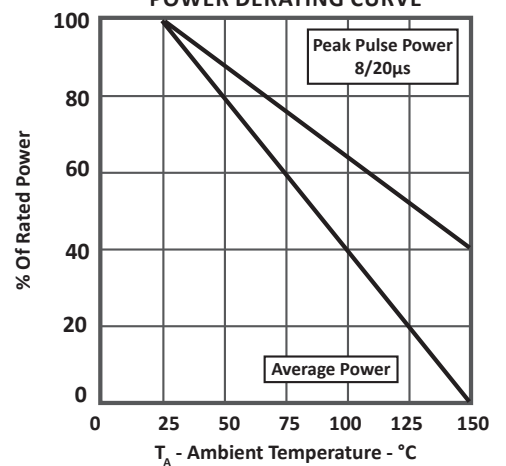

FIGURE 3
POWER DERATING CURVE



SOT-563 PACKAGE INFORMATION

OUTLINE DIMENSIONS				
DIM	MILLIMETERS		INCHES	
	MIN	MAX	MIN	MAX
A	1.50	1.70	0.059	0.067
B	1.10	1.30	0.043	0.051
C	0.50	0.60	0.020	0.024
D	0.17	0.27	0.007	0.011
G	0.50 BSC		0.020 BSC	
J	0.08	0.18	0.003	0.007
K	0.10	0.30	0.004	0.012
S	1.50	1.70	0.059	0.067

NOTES

- Controlling dimension: inches.
- Dimensioning and tolerances per ANSI Y14.5M, 1985.
- Dimensions are exclusive of mold flash and metal burrs.

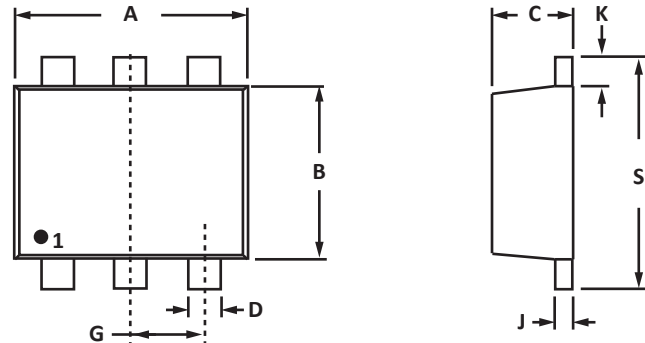

PAD LAYOUT DIMENSIONS		
DIM	MILLIMETERS	INCHES
	NOMINAL	NOMINAL
A	1.40	0.055
B	1.02	0.040
C	0.30	0.012
D	0.51	0.020
E	0.51	0.020

NOTES

- Controlling dimension: inches.

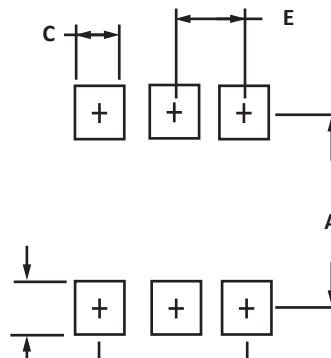

TAPE AND REEL

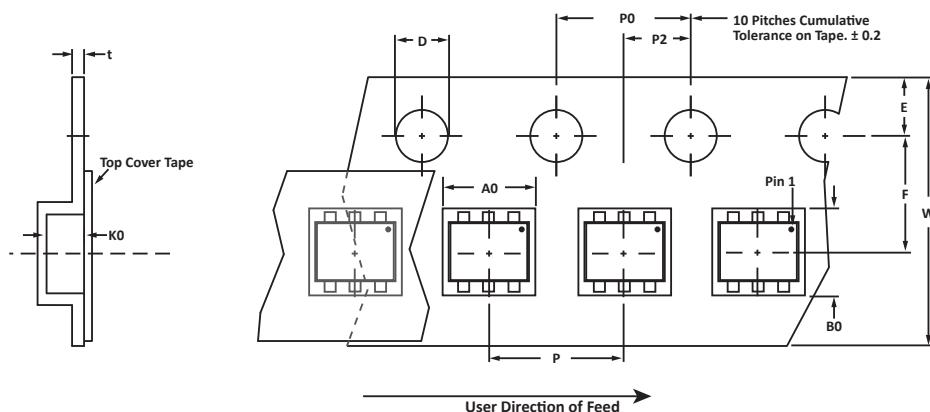

SPECIFICATIONS

REEL DIA.	TAPE WIDTH	A0	B0	K0	D	E	F	W	P0	P2	P	tmax
178mm (7")	8mm	1.78 ± 0.05	1.78 ± 0.05	0.69 ± 0.05	1.50 ± 0.10	1.75 ± 0.10	3.50 ± 0.05	8.00 ± 0.30	4.00 ± 0.10	2.00 ± 0.05	4.00 ± 0.10	0.25

NOTES

- Dimensions are in millimeters.
- Surface mount product is taped and reeled in accordance with EIA-481.
- Suffix - T7 = 7" Reel - 3,000 pieces per 8mm tape.
- Suffix - T13 = 13" Reel - 10,000 pieces per 8mm tape.
- Marking on Part - marking code (see page 2) and pin one defined by dot on package.

Package outline, pad layout and tape specifications per document number 06051.R3 3/11.

ORDERING INFORMATION

BASE PART NUMBER	LEADFREE SUFFIX	TAPE SUFFIX	QTY/REEL	REEL SIZE	TUBE QTY
PAM14ST6305LCC-NQ	n/a	-T7	3,000	7"	n/a
PAM14ST6305LCC-NQ	n/a	-T13	10,000	13"	n/a

This device is only available in a Lead-Free configuration.

Suffix -NQ = This is a commercial grade device and is not qualified to the AEC-Q101 standard. Please contact customer service for more information.

COMPANY INFORMATION

COMPANY PROFILE

In business more than 20 years, ProTek Devices™ is a privately-held company located in Tempe, Arizona, that offers a product line of transient voltage suppressors (TVS); avalanche breakdown diodes; steering diode TVS arrays and other surge suppressor component products. These TVS devices protect electronic systems from the effects of lightning, electrostatic discharge (ESD), nuclear electromagnetic pulses (NEMP), inductive switching and EMI / RFI. ProTek Devices also offers high performance interface and linear products that include analog switches; multiplexers; LED drivers; audio control ICs; RF and related high frequency products. The analog devices work in a host of consumer; industrial; automotive and other applications.

CONTACT US

Corporate Headquarters

2929 South Fair Lane
Tempe, Arizona 85282
USA

By Telephone

General: 602-431-8101
Sales: & Marketing: 602-414-5109
Customer Service: 602-414-5114
Product Technical Support: 602-414-5107

By Fax

General: 602-431-2288

By E-mail:

Sales: sales@protekdevices.com
Customer Service: service@protekdevices.com
Technical Support: support@protekdevices.com

ProTek Devices (Asia Pacific) Pte. Ltd.

8 Ubi Road 2, #06-19
Zervex
Singapore - 408538
Tel: +65-67488312
Fax: +65-67488313

Web

www.protekdevices.com

COPYRIGHT © ProTek Devices 2011 - This literature is subject to all applicable copyright laws and is not for resale in any manner.

SPECIFICATIONS: ProTek reserves the right to change the electrical and or mechanical characteristics described herein without notice.

DESIGN CHANGES: ProTek reserves the right to discontinue product lines without notice and that the final judgement concerning selection and specifications is the buyer's and that in furnishing engineering and technical assistance. ProTek assumes no responsibility with respect to the selection or specifications of such products. ProTek makes no warranty, representation or guarantee regarding the suitability of its products for any particular purpose, nor does ProTek assume any liability arising out of the application or use of any product or circuit and specifically disclaims any and all liability without limitation special, consequential or incidental damages.

LIFE SUPPORT POLICY: ProTek Devices products are not authorized for use in life support systems without written consent from the factory.