

## MULTI-LINE LOW CAPACITANCE TVS ARRAY

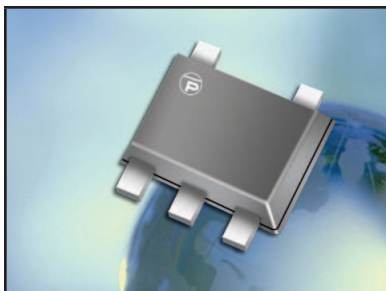

**SOT-553 PACKAGE**

### DESCRIPTION

The MSMF05LC is a 5 Volt, low capacitance, multi-line TVS array. This device is designed to protect wireless telecommunications and portable electronic applications from the damaging effects of ESD and EFT. The MSMF05LC is available in a 4 line unidirectional or 3 line bidirectional configuration with a working voltage of 5 Volts and a minimum breakdown voltage of 6 Volts. This device is rated at 25 Watts peak pulse power, which is sufficient protection for tertiary type lightning threats at key interface locations.

Packaged in a miniature SOT-553, the MSMF05LC meets IEC 61000-4-2 (ESD) and 61000-4-4 (EFT) immunity requirements. Each device should be placed near a connector to provide the best protection against transients.

### FEATURES

- Compatible with IEC 61000-4-2 (ESD): Air 15kV, Contact 8kV
- Compatible with IEC 61000-4-4 (EFT): 40A, 5/50ns
- 25 Watts Peak Pulse Power per Line ( $t_p = 8/20\mu s$ )
- Monolithic Design
- Available in 5 Volts
- Low Clamping Voltage
- ESD Protection > 25 kilovolts
- Low Leakage Current
- Low Capacitance: 9pF
- Protects 4 Unidirectional Lines or 3 Bidirectional Lines
- RoHS Compliant
- REACH Compliant

### APPLICATIONS

- Communication Systems
- SMART Phones
- Portable Electronics
- Video Interfaces

### MECHANICAL CHARACTERISTICS

- Molded JEDEC SOT-553 Package
- Approximate Weight: 3 milligrams
- Lead-Free Nickel Paladium Gold Plating
- Solder Reflow Temperature - 260-270°C
- Flammability Rating UL 94V-0
- 8mm Tape and Reel per EIA Standard 481

### PIN CONFIGURATION

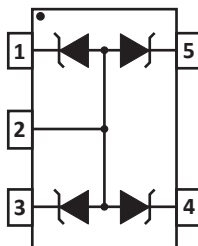

**TYPICAL DEVICE CHARACTERISTICS**
**MAXIMUM RATINGS @ 25°C Unless Otherwise Specified**

PARAMETER	SYMBOL	VALUE	UNITS
Peak Pulse Power (tp = 8/20μs) - See Figure 1	P <sub>PP</sub>	25	Watts
Operating Temperature	T <sub>L</sub>	-55 to 150	°C
Storage Temperature	T <sub>STG</sub>	-55 to 150	°C
Maximum Forward Voltage @ 10mA	V <sub>F</sub>	1.0	V

**ELECTRICAL CHARACTERISTICS PER LINE @ 25°C Unless Otherwise Specified**

PART NUMBER	DEVICE MARKING	RATED STAND-OFF VOLTAGE  V <sub>WM</sub> VOLTS	MINIMUM BREAKDOWN VOLTAGE  @ 1mA V <sub>(BR)</sub> VOLTS	MAXIMUM CLAMPING VOLTAGE (Fig. 2) @ I <sub>P</sub> = 2A V <sub>C</sub> VOLTS	MAXIMUM LEAKAGE CURRENT  @ V <sub>WM</sub> I <sub>D</sub> μA	TYPICAL CAPACITANCE (Note 1)  @ 0V, 1MHz C pF
MSMF05LC	5L	5.0	6.0	12.0	1	9

**NOTES**

1. Pins 1, 3, 4 or 5 to pin 2.

**TYPICAL DEVICE CHARACTERISTICS**

**FIGURE 1**  
**PEAK PULSE POWER VS PULSE TIME**

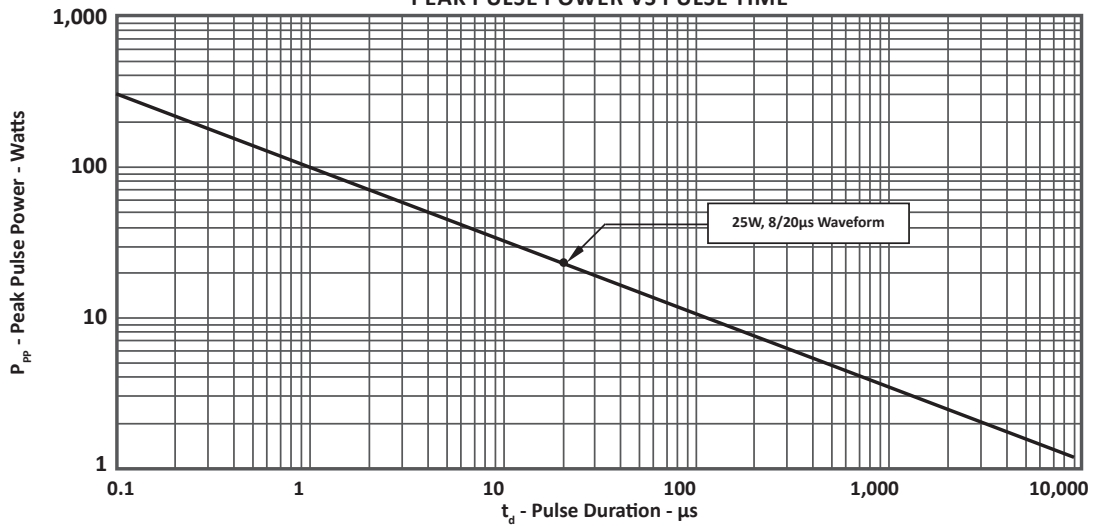

**FIGURE 2**  
**PULSE WAVE FORM**

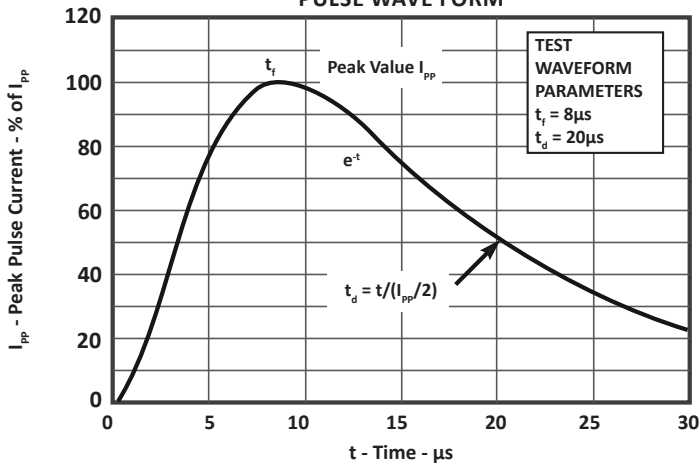

**FIGURE 3**  
**POWER DERATING CURVE**

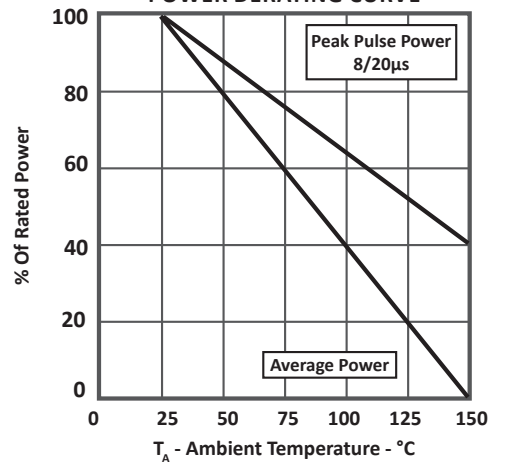

## SOT-553 PACKAGE INFORMATION

## OUTLINE DIMENSIONS

DIM	MILLIMETERS		INCHES	
	MIN	MAX	MIN	MAX
A	1.50	1.70	0.059	0.067
B	1.10	1.30	0.043	0.051
C	0.50	0.60	0.020	0.024
D	0.17	0.27	0.007	0.011
G	0.50 BSC		0.020 BSC	
J	0.08	0.18	0.003	0.007
K	0.10	0.30	0.004	0.012
S	1.50	1.70	0.059	0.067

## NOTES

- Controlling dimension: inches.
- Dimensioning and tolerances per ANSI Y14.5M, 1985.
- Dimensions are exclusive of mold flash and metal burrs.

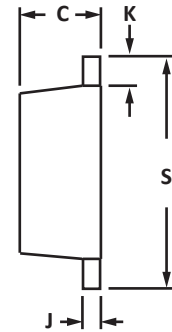
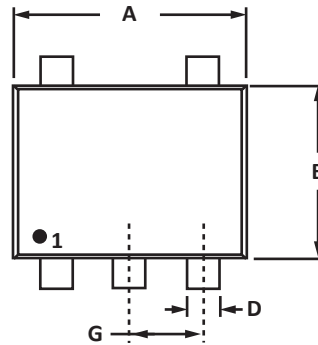

## PAD LAYOUT DIMENSIONS

DIM	MILLIMETERS	INCHES
	NOMINAL	NOMINAL
A	1.40	0.055
B	1.02	0.040
C	0.30	0.012
D	0.51	0.020
E	0.51	0.020

## NOTES

- Controlling dimension: inches.

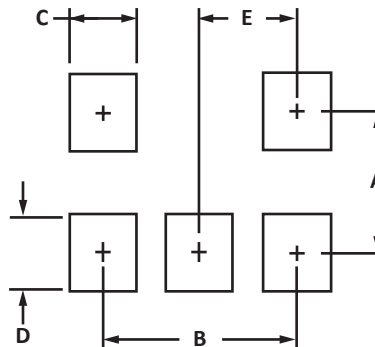

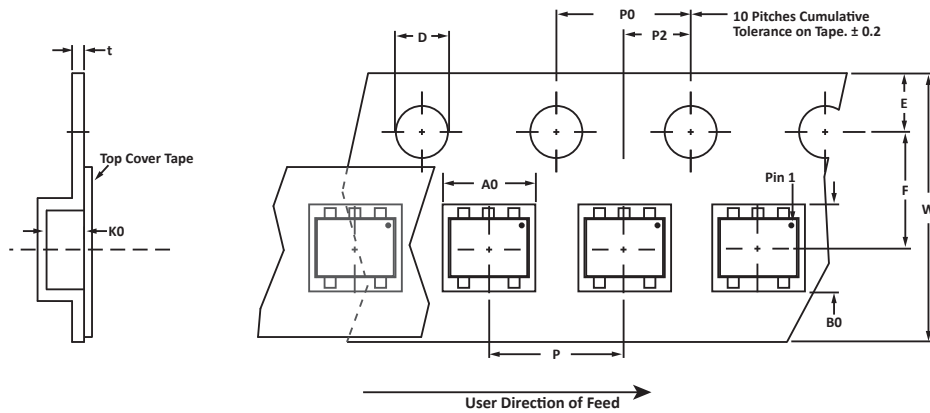
**TAPE AND REEL**

**SPECIFICATIONS**

REEL DIA.	TAPE WIDTH	A0	B0	K0	D	E	F	W	P0	P2	P	tmax
178mm (7")	8mm	1.78 ± 0.05	1.78 ± 0.05	0.69 ± 0.05	1.50 ± 0.10	1.75 ± 0.10	3.50 ± 0.05	8.00 ± 0.30	4.00 ± 0.10	2.00 ± 0.05	4.00 ± 0.10	0.25

**NOTES**

- Dimensions are in millimeters.
- Surface mount product is taped and reeled in accordance with EIA-481.
- Suffix - T7 = 7" Reel - 3,000 pieces per 8mm tape.
- Suffix - T13 = 13" Reel - 10,000 pieces per 8mm tape.
- Marking on Part - marking code (see page 2) and pin one defined by dot on package.

Package outline, pad layout and tape specifications per document number 06050.R3 3/11.

**ORDERING INFORMATION**

BASE PART NUMBER	LEADFREE SUFFIX	TAPE SUFFIX	QTY/REEL	REEL SIZE	TUBE QTY
MSMF05LC	-P	-T7	3,000	7"	n/a
MSMF05LC	-P	-T13	10,000	13"	n/a

This device is only available in a Lead-Free configuration.

## COMPANY INFORMATION

---

### COMPANY PROFILE

In business more than 20 years, ProTek Devices™ is a privately-held company located in Tempe, Arizona, that offers a product line of transient voltage suppressors (TVS); avalanche breakdown diodes; steering diode TVS arrays and other surge suppressor component products. These TVS devices protect electronic systems from the effects of lightning, electrostatic discharge (ESD), nuclear electromagnetic pulses (NEMP), inductive switching and EMI / RFI. ProTek Devices also offers high performance interface and linear products that include analog switches; multiplexers; LED drivers; audio control ICs; RF and related high frequency products. The analog devices work in a host of consumer; industrial; automotive and other applications.

### CONTACT US

#### Corporate Headquarters

2929 South Fair Lane  
Tempe, Arizona 85282  
USA

#### By Telephone

General: 602-431-8101  
Sales: & Marketing: 602-414-5109  
Customer Service: 602-414-5114  
Product Technical Support: 602-414-5107

#### By Fax

General: 602-431-2288

#### By E-mail:

Sales: [sales@protekdevices.com](mailto:sales@protekdevices.com)  
Customer Service: [service@protekdevices.com](mailto:service@protekdevices.com)  
Technical Support: [support@protekdevices.com](mailto:support@protekdevices.com)

#### ProTek Devices (Asia Pacific) Pte. Ltd.

8 Ubi Road 2, #06-19  
Zervex  
Singapore - 408538  
Tel: +65-67488312  
Fax: +65-67488313

#### Web

[www.protekdevices.com](http://www.protekdevices.com)

COPYRIGHT © ProTek Devices 2007 - This literature is subject to all applicable copyright laws and is not for resale in any manner.

SPECIFICATIONS: ProTek reserves the right to change the electrical and or mechanical characteristics described herein without notice.

DESIGN CHANGES: ProTek reserves the right to discontinue product lines without notice and that the final judgement concerning selection and specifications is the buyer's and that in furnishing engineering and technical assistance. ProTek assumes no responsibility with respect to the selection or specifications of such products. ProTek makes no warranty, representation or guarantee regarding the suitability of its products for any particular purpose, nor does ProTek assume any liability arising out of the application or use of any product or circuit and specifically disclaims any and all liability without limitation special, consequential or incidental damages.

LIFE SUPPORT POLICY: ProTek Devices products are not authorized for use in life support systems without written consent from the factory.