

MOS FET Relays G3VM-201AY/DY

Compact, General-purpose, Analog-switching MOS FET Relay, with Dielectric Strength of 5 kVAC between I/O Using Optical Isolation

- Trigger LED forward current of 2 mA (max.)
- Switches minute analog signals
- Continuous load current of 250 mA
- RoHS Compliant.

■ **Application Examples**

- Measurement devices
- Security systems and Power meters
- Industrial equipment

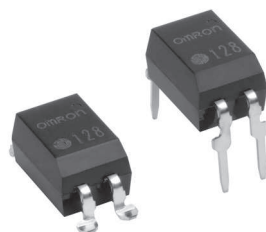

NEW

Note: The actual product is marked differently from the image shown here.

■ **List of Models**

Contact form	Terminals	Load voltage (peak value)	Model	Number per stick	Number per tape
SPST-NO	PCB terminals	200 V	G3VM-201AY	100	---
	Surface-mounting terminals		G3VM-201DY		
				G3VM-201DY(TR)	

Note: The AC peak and DC value are given for the load voltage.

■ **Dimensions**

Note: All units are in millimeters unless otherwise indicated.

G3VM-201AY

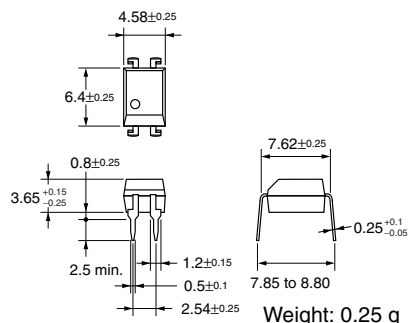
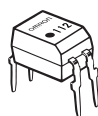

Note: The actual product is marked differently from the image shown here.

G3VM-201DY

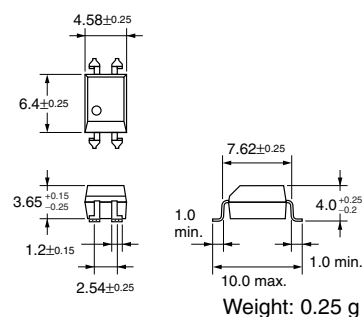

Note: The actual product is marked differently from the image shown here.

■ **Terminal Arrangement/Internal Connections (Top View)**

G3VM-201AY

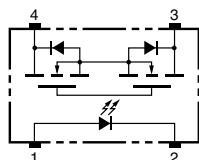

G3VM-201DY

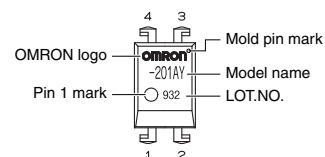
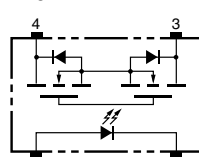

Note: The actual product is marked differently from the image shown here.

■ **PCB Dimensions (Bottom View)**

G3VM-201AY

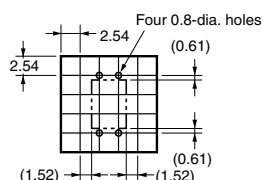

■ **Actual Mounting Pad Dimensions (Recommended Value, Top View)**

G3VM-201DY

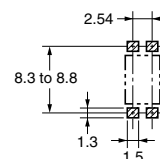

■ Absolute Maximum Ratings (Ta = 25°C)

Item	Symbol	Rating	Unit	Measurement conditions	
Input	LED forward current	I_F	30	mA	
	Repetitive peak LED forward current	I_{FP}	1	A	100 μ s pulses, 100 pps
	LED forward current reduction rate	$\Delta I_F/^\circ\text{C}$	-0.3	mA/°C	Ta \geq 25°C
	LED reverse voltage	V_R	5	V	
	Connection temperature	T_j	125	°C	
Output	Load voltage (AC peak/DC)	V_{OFF}	200	V	
	Continuous load current (AC peak/DC)	I_O	250	mA	
	ON current reduction rate	$\Delta I_{ON}/^\circ\text{C}$	-2.5	mA/°C	Ta \geq 25°C
	Pulse ON current	I_{OP}	0.75	A	t=100 mS
	Connection temperature	T_j	125	°C	
Dielectric strength between input and output (See note 1.)	V_{I-O}	5,000	V_{rms}	AC for 1 min	
Operating temperature	T_a	-40 to +85	°C	With no icing or condensation	
Storage temperature	T_{stg}	-55 to +125	°C	With no icing or condensation	
Soldering temperature (10 s)	---	260	°C	10 s	

Note: 1. The dielectric strength between the input and output was checked by applying voltage between all pins as a group on the LED side and all pins as a group on the light-receiving side.

■ Electrical Characteristics (Ta = 25°C)

Item	Symbol	Minimum	Typical	Maximum	Unit	Measurement conditions	
Input	LED forward voltage	V_F	1.45	1.63	1.75	V	$I_F = 10$ mA
	Reverse current	I_R	---	---	10	μ A	$V_R = 5$ V
	Capacity between terminals	C_T	---	40	---	pF	$V = 0$, $f = 1$ MHz
	Trigger LED forward current	I_{FT}	---	0.3	2	mA	$I_O = 250$ mA
Output	Maximum resistance with output ON	R_{ON}	---	5	8	Ω	$I_F = 5$ mA, $I_O = 250$ mA, $t < 1$ s
	Current leakage when the relay is open	I_{LEAK}	---	---	1.0	μ A	$V_{OFF} = 200$ V
	Capacity between terminals	C_{OFF}	---	90	---	pF	$V = 0$, $f = 1$ MHz
Capacity between I/O terminals	C_{I-O}	---	0.8	---	pF	$f = 1$ MHz, $V_s = 0$ V	
Insulation resistance	R_{I-O}	1,000	---	---	M Ω	$V_{I-O} = 500$ VDC, $R_{OH} \leq 60\%$	
Turn-ON time	t_{ON}	---	0.5	1.0	ms	$I_F = 5$ mA, $R_L = 200$ Ω , $V_{DD} = 20$ V (See note 2.)	
Turn-OFF time	t_{OFF}	---	0.2	1.0	ms		

Note: 2. Turn-ON and Turn-OFF Times

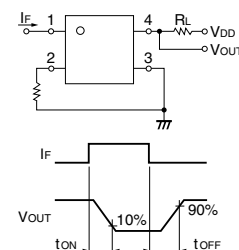

■ Recommended Operating Conditions

Use the G3VM under the following conditions so that the Relay will operate properly.

Item	Symbol	Minimum	Typical	Maximum	Unit
Load voltage (AC peak/DC)	V_{DD}	---	---	160	V
Operating LED forward current	I_F	3	5	20	mA
Continuous load current (AC peak/DC)	I_O	---	---	250	mA
Operating temperature	T_a	-20	---	65	°C

■ Engineering Data

LED forward current vs. Ambient temperature

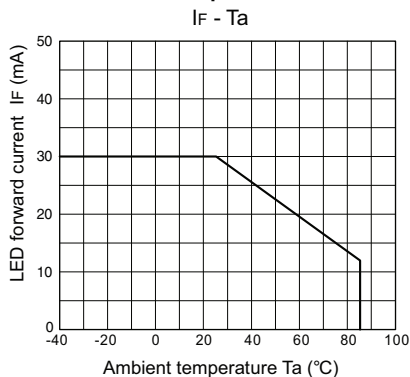

Continuous load current vs. Ambient temperature

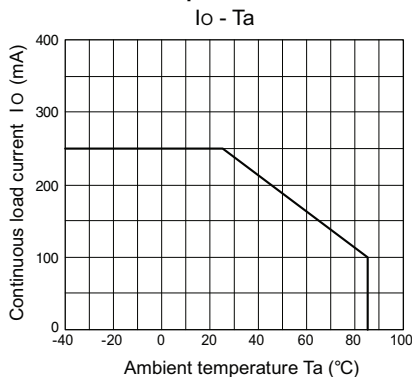

LED forward current vs. LED forward voltage

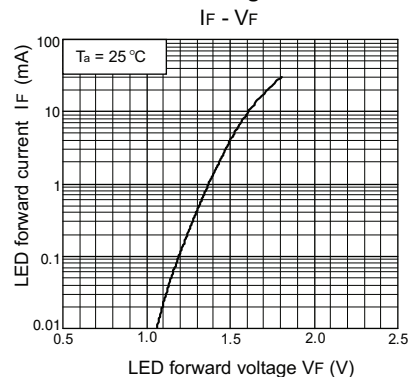

Continuous load current vs. On-state voltage

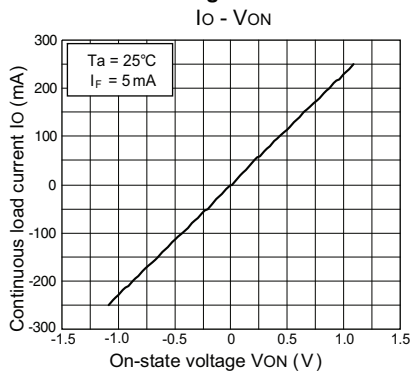

On-state resistance vs. Ambient temperature

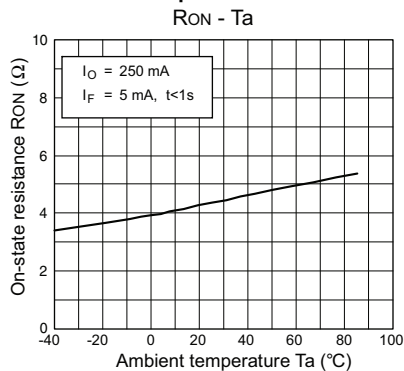

Trigger LED forward current vs. Ambient temperature

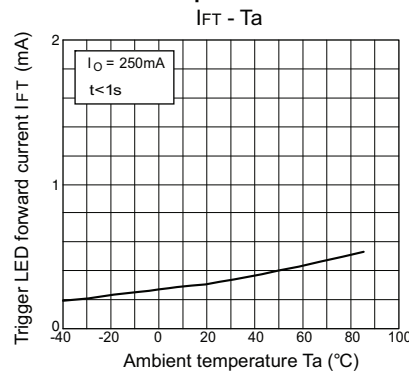

Turn ON, Turn OFF time vs. LED forward current

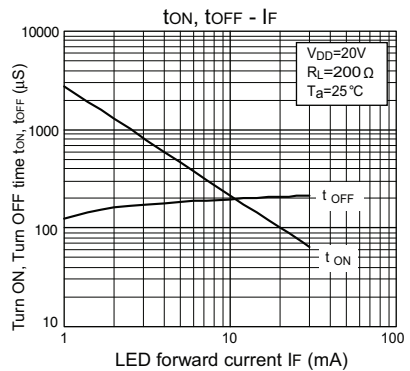

Turn ON, Turn OFF time vs. Ambient temperature

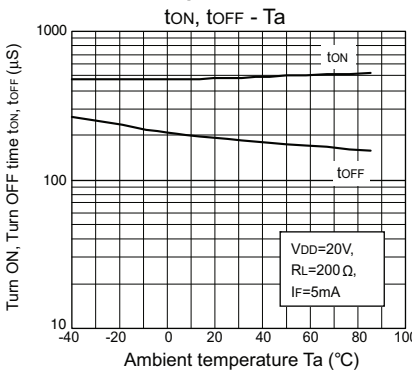

Current leakage vs. Ambient temperature

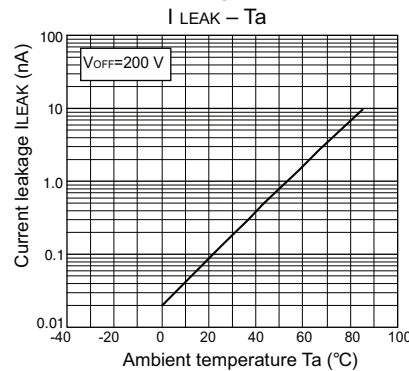

All sales are subject to Omron Electronic Components LLC standard terms and conditions of sale, which can be found at http://www.components.omron.com/components/web/webfiles.nsf/sales_terms.html

ALL DIMENSIONS SHOWN ARE IN MILLIMETERS.
To convert millimeters into inches, multiply by 0.03937. To convert grams into ounces, multiply by 0.03527.

OMRON[®]

**OMRON ELECTRONIC
COMPONENTS LLC**

55 E. Commerce Drive, Suite B
Schaumburg, IL 60173

847-882-2288

OMRON ON-LINE

Global - <http://www.omron.com>

USA - <http://www.components.omron.com>

Cat. No. G3VM-201AY/DY_1

11/11

Specifications subject to change without notice

Printed in USA