

## Mounting Kits, DIN Rail Strips and Accessories

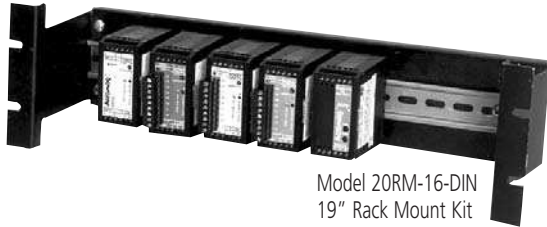

Model 20RM-16-DIN  
19" Rack Mount Kit

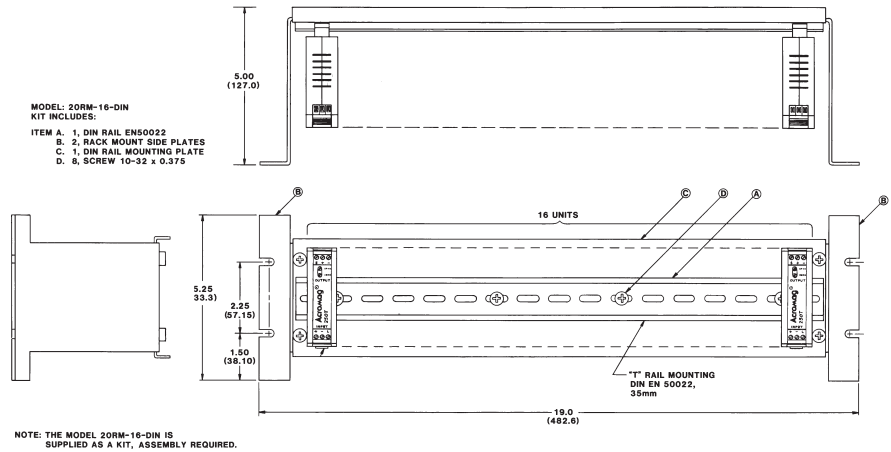

Simplifies mounting of Acromag I/O Modules ♦ Ideal for mounting in test stands and instrument racks

### Description

For your convenience, Acromag offers several mounting accessories to simplify your system installation. Our 19" rack-mount kit provides a clean solution for mounting your I/O modules and a power supply. Or, you can buy pre-cut DIN rail strips for mounting on any flat surface.

### Ordering Information

NOTE: For more information visit [www.acromag.com](http://www.acromag.com).

### Mounting Accessories

#### 1025-673

Retro-fit mounting bracket for 150T-XJSM explosion-proof housing (enables Flat Pack 250T mounting)

#### 20RM-16-DIN

19" rack-mount kit with DIN rail

#### DIN RAIL 3.0

DIN rail strip, Type T, 3 inches (75mm)

#### DIN RAIL 16.7

DIN rail strip, Type T, 16.7 inches (425mm)

#### ESA-DIN-HMK

DIN rail horizontal mounting kit, holds three EtherStax units.

#### ESA-DIN-VMK

DIN rail vertical mounting kit, holds two EtherStax units.

#### ESA-OMK

Open circuit board EtherStax mounting kit, stacks two units.

#### ESA-SMK

Surface mounting EtherStax kit, mounts up to three units.



ESA-DIN-HMK kit (horizontal terminals).

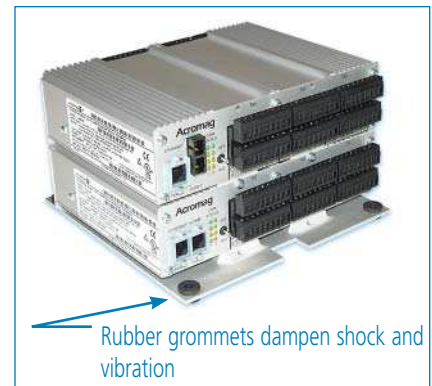

Rubber grommets dampen shock and vibration

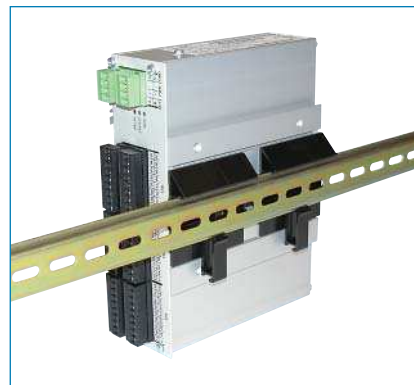

ESA-DIN-VMK kit (vertical terminals).

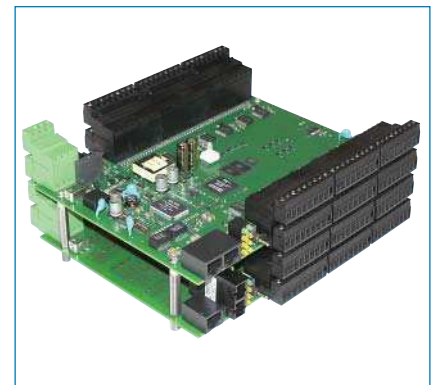

ESA-OMK open board stacking kit. One kit supplies standoffs to stack two units.

## Mounting Mounting kits, DIN rail strips and accessories

### 1025-673 Mounting Bracket

For retro-fit of 150T explosion-proof housings with Flat Pack instruments

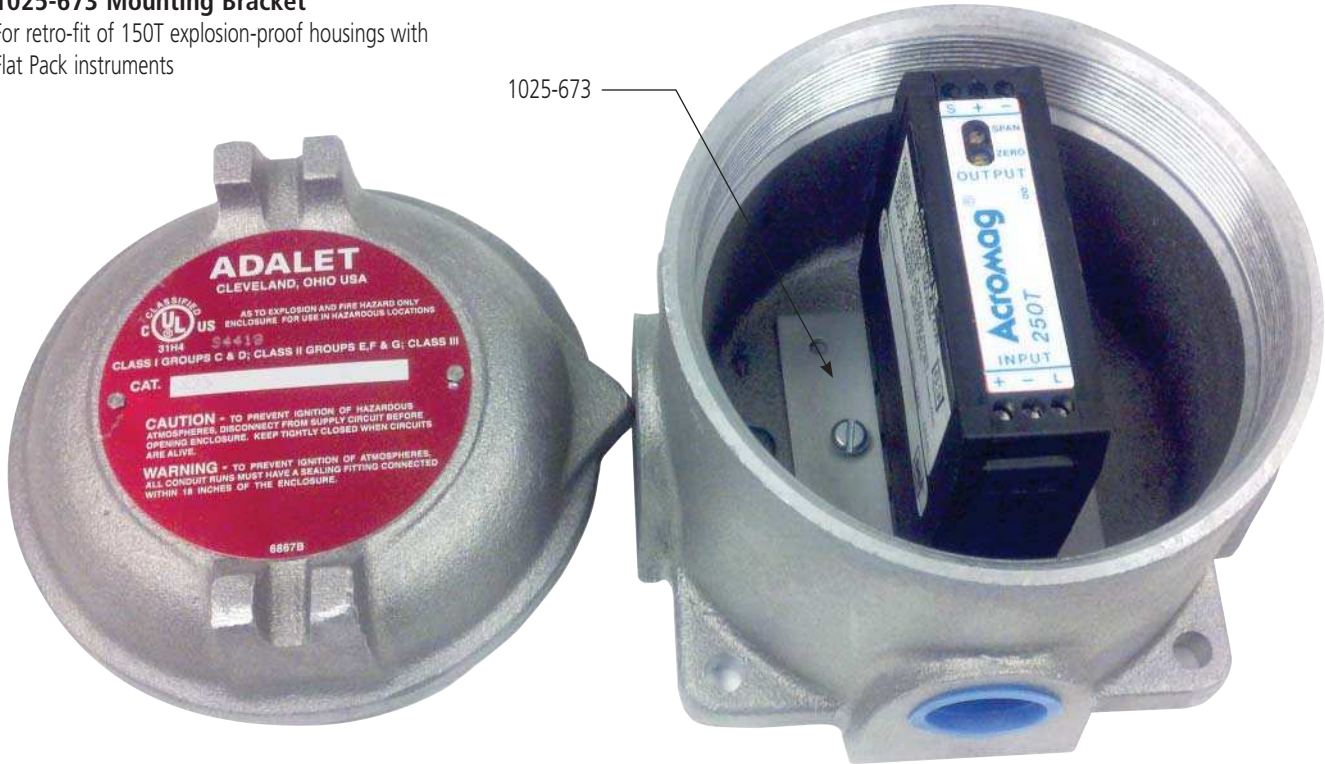

### 150T-XJSM-WM, 150T-XJSM-PM (retired products), Explosion-Proof Housing Wall-Mount, Pipe-Mount

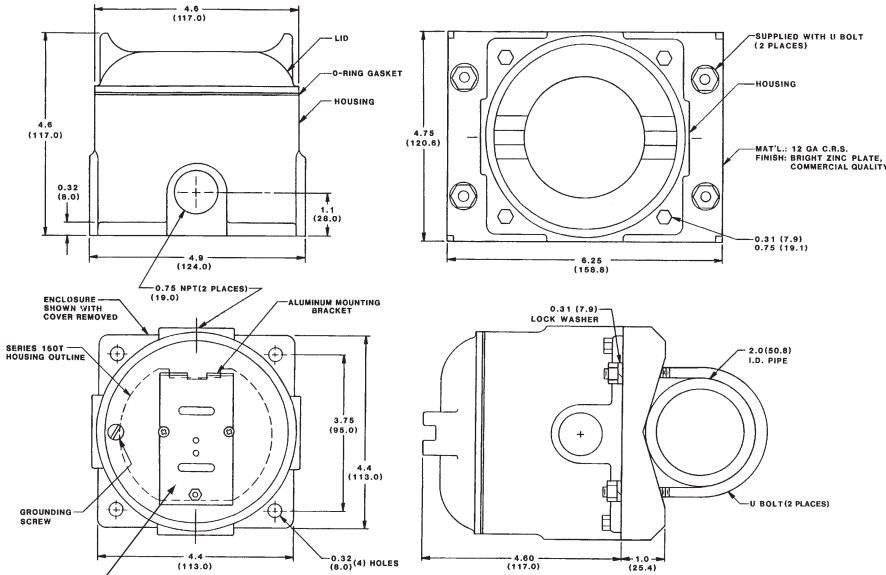

Replace original bracket with Part #1025-673 for mounting of Flat Pack 250T transmitters

