

TECHNICAL DATA
DATA SHEET 4803, REV. -

HERMETIC POWER SCHOTTKY RECTIFIER 150°C Maximum Operation Temperature

DESCRIPTION: A 30-VOLT, 35 AMP, POWER SCHOTTKY RECTIFIER IN A HERMETIC TO-254 PACKAGE.

MAXIMUM RATINGS

ALL RATINGS ARE @ $T_C = 25^\circ\text{C}$ UNLESS OTHERWISE SPECIFIED.

RATING	SYMBOL	MAX.	UNITS
PEAK INVERSE VOLTAGE	PIV	30	Volts
MAXIMUM DC OUTPUT CURRENT (@ $T_C=100^\circ\text{C}$) (Single, Doubler)	I_o	35	Amps
MAXIMUM DC OUTPUT CURRENT (@ $T_C=100^\circ\text{C}$) (Common Cathode, Common Anode)	I_o	35	Amps
MAXIMUM NONREPETITIVE FORWARD SURGE CURRENT (t=8.3ms, Sine)	I_{FSM}	150	Amps
MAXIMUM JUNCTION CAPACITANCE ($V_r=5\text{V}$)	C_T	2635	pF
MAXIMUM THERMAL RESISTANCE (Single)	$R_{\theta JC}$	1.25	$^\circ\text{C/W}$
MAXIMUM THERMAL RESISTANCE (Common Cathode, Common Anode, Doubler)	$R_{\theta JC}$	0.63	$^\circ\text{C/W}$
MAXIMUM OPERATING TEMPERATURE RANGE	Top/Tstg	-55 to + 150	$^\circ\text{C}$
MAXIMUM STORAGE TEMPERATURE RANGE	Top/Tstg	-55 to + 150	$^\circ\text{C}$

ELECTRICAL CHARACTERISTICS

CHARACTERISTIC	SYMBOL	MAX.	UNITS
MAXIMUM FORWARD VOLTAGE DROP, Pulsed ($I_f = 35$ Amps) $T_J = 25^\circ\text{C}$ $T_J = 125^\circ\text{C}$	V_f	0.81 0.84	Volts
MAXIMUM REVERSE CURRENT (I_r @ 30 V PIV) $T_J = 25^\circ\text{C}$ $T_J = 125^\circ\text{C}$	I_r	0.4 230	mA

SENSITRON
DATA SHEET 4803, REV. -

Mechanical Dimensions: In inches / mm

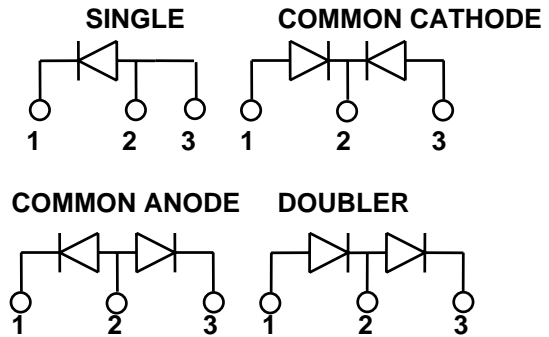
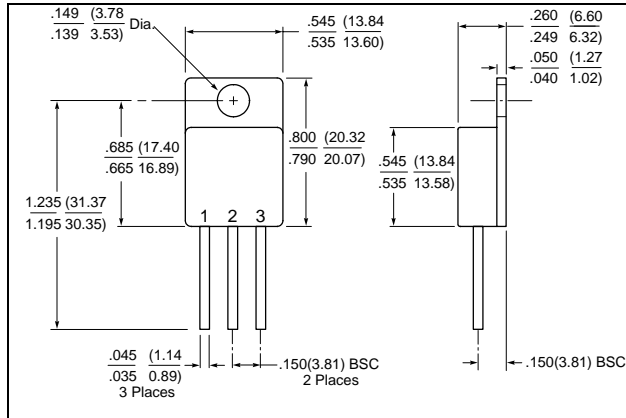

TO-254

PINOUT TABLE

TYPE	PIN 1	PIN 2	PIN 3
SINGLE RECTIFIER	CATHODE	ANODE	ANODE
DUAL RECTIFIER, COMMON CATHODE (P)	ANODE 1	COMMON CATHODE	ANODE 2
DUAL RECTIFIER, COMMON ANODE (N)	CATHODE 1	COMMON ANODE	CATHODE 2
DUAL RECTIFIER, DOUBLER (D)	ANODE	CATHODE/ ANODE	CATHODE

Curves shown are for bare die only.

TECHNICAL DATA

DISCLAIMER:

- 1- The information given herein, including the specifications and dimensions, is subject to change without prior notice to improve product characteristics. Before ordering, purchasers are advised to contact the Sensitron Semiconductor sales department for the latest version of the datasheet(s).
- 2- In cases where extremely high reliability is required (such as use in nuclear power control, aerospace and aviation, traffic equipment, medical equipment, and safety equipment), safety should be ensured by using semiconductor devices that feature assured safety or by means of users' fail-safe precautions or other arrangement.
- 3- In no event shall Sensitron Semiconductor be liable for any damages that may result from an accident or any other cause during operation of the user's units according to the datasheet(s). Sensitron Semiconductor assumes no responsibility for any intellectual property claims or any other problems that may result from applications of information, products or circuits described in the datasheets.
- 4- In no event shall Sensitron Semiconductor be liable for any failure in a semiconductor device or any secondary damage resulting from use at a value exceeding the absolute maximum rating.
- 5- No license is granted by the datasheet(s) under any patents or other rights of any third party or Sensitron Semiconductor.
- 6- The datasheet(s) may not be reproduced or duplicated, in any form, in whole or part, without the expressed written permission of Sensitron Semiconductor.
- 7- The products (technologies) described in the datasheet(s) are not to be provided to any party whose purpose in their application will hinder maintenance of international peace and safety nor are they to be applied to that purpose by their direct purchasers or any third party. When exporting these products (technologies), the necessary procedures are to be taken in accordance with related laws and regulations.